

Smart Fiber Amplifier Unit E3X-HD

CSM_E3X-HD_DS_E_7_4



Easy and optimum settings for anyone Smart Fiber Amplifier Unit with Long-term Stable Detection

- Equipped with Smart Tuning, which automatically configures the settings to their optimum values with the press of a single button.
- Highly usable design enables anyone to configure the settings easily.
- Detects dirt, vibrations, and LED deterioration, and automatically compensates the incident level and the light intensity.
- Unparalleled best-in-class power provides stable detections for low-reflective workpieces and large workpieces (equipped with GIGA RAY II).

⚠ Refer to the *Fiber Sensors Technical Guide* and *Safety Precautions* on page 9.



For the most recent information on models that have been certified for safety standards, refer to your OMRON website.

Features

Easy

Greater operability and visibility are realized by a universal design

Operations

Symbolic buttons are easy to remember anywhere even for operators overseas.



Compatibility for easy operation and incorrect operation prevention.



Pleasant operation even with gloves on.



Arc Design

A strong accent line gives a compact look to improve equipment design.

Indications

Visibility is improved with digital displays and visible indicators. New Concept: Visible Indicators

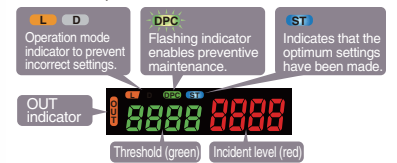

Smart Tuning

Smart tuning for the optimum settings with just one button.

Smart Tuning

Automatically configure the settings to their optimum values with the press of a single button.

With workpiece Without workpiece

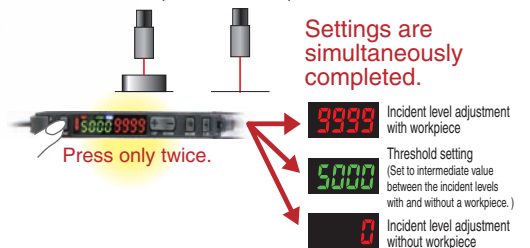

Stable

Long-term stable detection with no maintenance

Smart Power Control

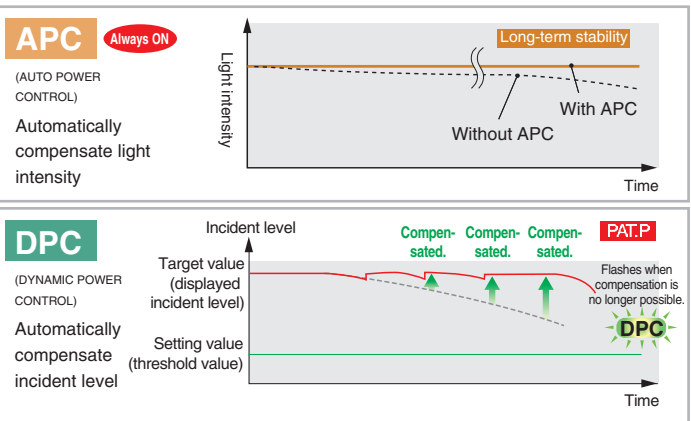

Maintenance-free operation by double compensation of light intensity and incident level



Ordering Information

Fiber Amplifier Units

Standard models (Dimensions → page 12)

| Appearance | Connecting method | Models | |
|---|-----------------------|-------------|-------------|
| | | NPN output | PNP output |
|  | Pre-wired (2 m) | E3X-HD11 2M | E3X-HD41 2M |
|  | Wire-saving Connector | E3X-HD6 | E3X-HD8 |
|  | M8 Connector | E3X-HD14 | E3X-HD44 |



Model for Sensor Communications Unit (Dimensions → page 12)

| Appearance | Model | Applicable Sensor Communications Unit |
|---|---------|---------------------------------------|
|  | E3X-HD0 | E3X-ECT E3X-CRT |

Accessories (sold separately)



Wire-saving connectors (Required for models for Wire-saving Connectors.)

Connectors are not provided with the Fiber Amplifier Unit and must be ordered separately. * Protective stickers: provided.

| Type | Appearance | Cable length | Number of conductors | Models |
|------------------|---|--------------|----------------------|----------|
| Master Connector |  | 2 m | 3 | E3X-CN11 |
| Slave Connector |  | | 1 | E3X-CN12 |

Sensor I/O Connectors (Required for models with M8 Connectors.)

Connectors are not provided with the Fiber Amplifier Unit and must be ordered separately.

| Size | Cable | Appearance | Cable type | Models | |
|------|----------|--|------------|--------|-----------------|
| M8 | Standard | Straight  | 2 m | 4-wire | XS3F-M421-402-A |
| | | | 5 m | | XS3F-M421-405-A |
| | | L-shaped  | 2 m | | XS3F-M422-402-A |
| | | | 5 m | | XS3F-M422-405-A |

Mounting Bracket

A Mounting Bracket is not provided with the Fiber Amplifier Unit and must be ordered separately as required.

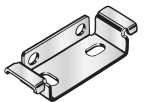
| Appearance | Model | Quantity |
|---|----------|----------|
|  | E39-L143 | 1 |

DIN Track

A Din Track is not provided with the Fiber Amplifier Unit and must be ordered separately as required.

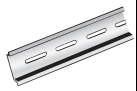
| Appearance | Type | Models | Quantity |
|---|-----------------------------------|-----------|----------|
|  | Shallow type, total length: 1 m | PFP-100N | 1 |
| | Shallow type, total length: 0.5 m | PFP-50N | |
| | Deep type, total length: 1 m | PFP-100N2 | |

End Plate

Two End Plates are provided with the Sensor Communications Unit. End Plates are not provided with the Fiber Amplifier Unit and must be ordered separately as required.

| Appearance | Model | Quantity |
|---|-------|----------|
|  | PFP-M | 1 |

Ratings and Specifications

| Item | Type | Standard | | | Model for Sensor Communications Unit *1 |
|--------------------------------------|--------------------------------|--|-------------------------------|-------------------------------|--|
| | NPN output | E3X-HD11 | E3X-HD6 | E3X-HD14 | E3X-HD0 |
| | PNP output | E3X-HD41 | E3X-HD8 | E3X-HD44 | |
| | Connecting method | Pre-wired | Wire-saving Connector *2 | M8 Connector | Connector for Sensor Communications Unit |
| Light source (wavelength) | | Red, 4-element LED (625 nm) | | | |
| Power supply voltage | | 12 to 24 VDC \pm 10%, ripple (P-P) 10% max. | | | Supplied from the connector through the Sensor Communications Unit |
| Power consumption | Normal mode | 720 mW max. (Current consumption: 30 mA max. at 24 VDC, 60 mA max. at 12 VDC) | | | |
| | Eco ON | 530 mW max. (Current consumption: 22 mA max. at 24 VDC, 44 mA max. at 12 VDC) | | | |
| | Eco LO | 640 mW max. (Current consumption: 26 mA max. at 24 VDC, 53 mA max. at 12 VDC) | | | – |
| Control output | | Load power supply voltage: 26.4 VDC max., open-collector output Load current: Groups of 1 to 3 Amplifier Units: 100mA max., Groups of 4 to 16 Amplifier Units: 20mA max. Residual voltage: At load current of less than 10 mA: 1 V max., At load current of 10 to 100 mA: 2 V max. OFF current: 0.1 mA max. | | | – |
| Protection circuits | | Power supply reverse polarity protection, output short-circuit protection and output reverse polarity protection | | | Power supply reverse polarity protection and output short-circuit protection |
| Response time | Super-high-speed mode (SHS) *3 | NPN outputs: Operate or reset: 50 μ s PNP outputs: Operate or reset: 55 μ s | | | – |
| | High-speed mode (HS) | Operate or reset: 250 μ s (default setting) | | | |
| | Standard mode (Stnd) | Operate or reset: 1 ms | | | |
| | Giga-power mode (GIGA) | Operate or reset: 16 ms | | | |
| Maximum connectable Units | | 16 units | | | with E3X-CRT: 16 units with E3X-ECT: 30 units |
| Mutual interference prevention | | Possible for up to 10 units (optical communications sync) *3 | | | |
| Auto power control (APC) | | Always ON | | | |
| Other functions | | Power tuning, differential detection, DPC, timer (OFF-delay, ON-delay, or one-shot), zero reset, resetting settings, and Eco mode | | | |
| Ambient illumination (Receiver side) | | Incandescent lamp: 20,000 lx max., Sunlight: 30,000 lx max. | | | |
| Ambient temperature range | | Operating: Groups of 1 to 2 Amplifiers: -25 to 55°C , Groups of 3 to 10 Amplifiers: -25 to 50°C , Groups of 11 to 16 Amplifiers: -25 to 45°C Storage: -30 to 70°C (with no icing or condensation) | | | Operating: Groups of 1 to 2 Amplifiers: 0 to 55°C , Groups of 3 to 10 Amplifiers: 0 to 50°C , Groups of 11 to 16 Amplifiers: 0 to 45°C , Groups of 17 to 30 Amplifiers: 0 to 40°C Storage: -30 to 70°C (with no icing or condensation) |
| Ambient humidity range | | Operating and storage: 35% to 85% (with no condensation) | | | |
| Insulation resistance | | 20 M Ω min. (at 500 VDC) | | | |
| Dielectric strength | | 1,000 VAC at 50/60 Hz for 1 minute | | | |
| Vibration resistance (destruction) | | 10 to 55 Hz with a 1.5-mm double amplitude for 2 hours each in X, Y, and Z directions | | | 10 to 150 Hz with a 0.7-mm double amplitude for 80 minutes each in X, Y, and Z directions |
| Shock resistance (destruction) | | 500 m/s ² for 3 times each in X, Y, and Z directions | | | 150 m/s ² for 3 times each in X, Y, and Z directions |
| Degree of protection | | IEC 60529 IP50 (with Protective Cover attached) | | | |
| Weight (packed state/unit only) | | Approx. 105 g/ Approx. 65 g | Approx. 60 g/ Approx. 20 g | Approx. 70 g/ Approx. 25 g | Approx. 65 g/Approx. 25 g |
| Materials | Case | Polycarbonate (PC) | | | Heat-resistant ABS (connector: PBT) |
| | Cover | Polycarbonate (PC) | | | |
| | Cable | PVC | – | | |
| Accessories | | Instruction Manual | | | |

*1. The E3X-ECT EtherCAT Sensor Communications Unit and the E3X-CRT CompoNet Sensor Communications Unit can be used.

*2. Use either the E3X-CN11 (master connector, 3 conductors) or the E3X-CN12 (slave connector, 1 conductor).

*3. The communications function and mutual interference prevention function are disabled when the detection mode is set to Super-high-speed mode (SHS).
When including E3X-DA-S with activated power tuning, mutual interference prevention is possible for up to 6 units.
When including E3X-MDA with activated power tuning, mutual interference prevention is possible for up to 5 units.
E3X-DA□-S Series in this catalog have been discontinued at the end of March 2017 and end of March 2019.
E3X-MDA Series will be accepted until the end of August 2021.

Sensing Distances

Threaded Models

| Sensing method | Sensing direction | Size | Model | Sensing distance (mm) | | | |
|----------------|-------------------|-------------|--------------|-----------------------|---------------|-----------------|-----------------------|
| | | | | Giga mode | Standard mode | High-speed mode | Super-high-speed mode |
| Through-beam | Right-angle | M4 | E32-T11N 2M | 2,000 | 1,000 | 700 | 280 |
| | | | E32-LT11N 2M | 4,000 * | 3,500 | 2,300 | 920 |
| | | | E32-T11R 2M | 2,000 | 1,000 | 700 | 280 |
| | Straight | | E32-LT11 2M | 4,000 * | 4,000 * | 2,700 | 1,080 |
| | | | E32-LT11R 2M | 4,000 * | 3,500 | 2,300 | 920 |
| Reflective | Right-angle | M3 | E32-C31N 2M | 110 | 50 | 46 | 14 |
| | | | E32-C21N 2M | 290 | 130 | 90 | 39 |
| | | M4 | E32-D21N 2M | 840 | 350 | 240 | 100 |
| | | | E32-C11N 2M | 780 | 350 | 320 | 100 |
| | | M6 | E32-LD11N 2M | 840 | 350 | 240 | 100 |
| | | | E32-D21R 2M | 140 | 60 | 40 | 16 |
| | Straight | M3 | E32-C31 2M | 330 | 150 | 100 | 44 |
| | | | E32-C31M 1M | | | | |
| | | | M4 | E32-D211R 2M | 140 | 60 | 40 |
| | | E32-D11R 2M | | 840 | 350 | 240 | 100 |
| | | M6 | E32-CC200 2M | 1,400 | 600 | 400 | 180 |
| | | | E32-LD11 2M | 860 | 360 | 250 | 110 |
| | | | E32-LD11R 2M | 840 | 350 | 240 | 100 |

* The fiber length is 2 m on each side, so the sensing distance is given as 4,000 mm.

Cylindrical Models

| Sensing method | Size | Sensing direction | Model | Sensing distance (mm) | | | |
|---------------------|------------|-------------------|--------------|-----------------------|---------------|-----------------|-----------------------|
| | | | | Giga mode | Standard mode | High-speed mode | Super-high-speed mode |
| Through-beam | 1 dia. | Top-view | E32-T223R 2M | 450 | 250 | 150 | 60 |
| | 1.5 dia. | | E32-T22B 2M | 680 | 400 | 220 | 90 |
| | 3 dia. | | E32-T12R 2M | 2,000 | 1,000 | 700 | 280 |
| | Reflective | 1.5 dia. | Side-view | E32-T14LR 2M | 750 | 450 | 260 |
| E32-D22B 2M | | | | 140 | 60 | 40 | 16 |
| 1.5 dia. + 0.5 dia. | | Top-view | E32-D43M 1M | 28 | 12 | 8 | 4 |
| | | | E32-D22R 2M | 140 | 60 | 40 | 16 |
| E32-D221B 2M | | | 300 | 140 | 90 | 40 | |
| 3 dia. | | | E32-D32L 2M | 700 | 300 | 200 | 90 |
| | | | E32-D33 2M | 70 | 30 | 20 | 8 |
| 3 dia. + 0.8 dia. | | | | | | | |

Flat Models

| Sensing method | Sensing direction | Model | Sensing distance (mm) | | | |
|----------------|-------------------|--------------|-----------------------|---------------|-----------------|-----------------------|
| | | | Giga mode | Standard mode | High-speed mode | Super-high-speed mode |
| Through-beam | Top-view | E32-T15XR 2M | 2,000 | 1,000 | 700 | 280 |
| | Side-view | E32-T15YR 2M | 750 | 450 | 260 | 100 |
| | Flat-view | E32-T15ZR 2M | | | | |
| Reflective | Top-view | E32-D15XR 2M | 840 | 350 | 240 | 100 |
| | Side-view | E32-D15YR 2M | 200 | 100 | 52 | 24 |
| | Flat-view | E32-D15ZR 2M | | | | |

Sleeve Models

| Sensing method | Sensing direction | Model | Sensing distance (mm) | | | |
|----------------|-------------------|-----------------|-----------------------|---------------|-----------------|-----------------------|
| | | | Giga mode | Standard mode | High-speed mode | Super-high-speed mode |
| Through-beam | Side-view | E32-T24R 2M | 170 | 100 | 50 | 20 |
| | | E32-T24E 2M | 450 | 250 | 150 | 60 |
| | Top-view | E32-T33 1M | 150 | 90 | 50 | 20 |
| | | E32-T21-S1 2M | 510 | 300 | 170 | 68 |
| | | E32-TC200BR 2M | 2,000 | 1,000 | 700 | 280 |
| Reflective | Side-view | E32-D24R 2M | 70 | 30 | 20 | 8 |
| | | E32-D24-S2 2M | 120 | 53 | 45 | 14 |
| | Top-view | E32-D43M 1M | 28 | 12 | 8 | 4 |
| | | E32-D331 2M | 14 | 6 | 4 | 2 |
| | | E32-D33 2M | 70 | 30 | 20 | 8 |
| | | E32-D32-S1 0.5M | 63 | 27 | 18 | 7 |
| | | E32-D31-S1 0.5M | | | | |
| | | E32-DC200F4R 2M | 140 | 60 | 40 | 16 |
| | | E32-D22-S1 2M | 250 | 110 | 72 | 30 |
| | | E32-D21-S3 2M | | | | |
| | | E32-DC200BR 2M | 840 | 350 | 240 | 100 |
| | | E32-D25-S3 2M | 250 | 110 | 72 | 30 |

Small-spot, Reflective Models

| Type | Spot diameter | Center distance (mm) | Model | Sensing distance (mm) | | | |
|---------------------|-----------------|----------------------|-----------------------|--|---------------|-----------------|-----------------------|
| | | | | Giga mode | Standard mode | High-speed mode | Super-high-speed mode |
| Variable spot | 0.1 to 0.6 dia. | 6 to 15 | E32-C42 1M+E39-F3A | Spot diameter of 0.1 to 0.6 mm at 6 to 15 mm. | | | |
| | 0.3 to 1.6 dia. | 10 to 30 | E32-C42 1M+E39-F17 | Spot diameter of 0.3 to 1.6 mm at 10 to 30 mm. | | | |
| Parallel light | 4 dia. | 0 to 20 | E32-C31 2M+E39-F3C | Spot diameter of 4 mm max. at 0 to 20 mm. | | | |
| | | | E32-C31N 2M+E39-F3C | | | | |
| Integrated lens | 0.1 dia. | 5 | E32-C42S 1M | Spot diameter of 0.1 mm at 5 mm. | | | |
| | 6 dia. | 50 | E32-L15 2M | Spot diameter of 6 mm at 50 mm. | | | |
| Small-spot | 0.1 dia. | 7 | E32-C41 1M+E39-F3A-5 | Spot diameter of 0.1 mm at 7 mm. | | | |
| | 0.5 dia. | | E32-C31 2M+E39-F3A-5 | Spot diameter of 0.5 mm at 7 mm. | | | |
| | | | E32-C31N 2M+E39-F3A-5 | | | | |
| | 0.2 dia. | 17 | E32-C41 1M+E39-F3B | Spot diameter of 0.2 mm at 17 mm. | | | |
| | 0.5 dia. | | E32-C31 2M+E39-F3B | Spot diameter of 0.5 mm at 17 mm. | | | |
| | 3 dia. | 50 | E32-CC200 2M+E39-F18 | | | | |
| E32-C11N 2M+E39-F18 | | | | | | | |

High-power Beam Models

| Type | Sensing direction | Aperture angle | Model | Sensing distance (mm) | | | |
|--|-------------------|----------------------|-----------------------|-----------------------|---------------|-----------------|-----------------------|
| | | | | Giga mode | Standard mode | High-speed mode | Super-high-speed mode |
| Through-beam models with integrated lens | Right-angle | 15° | E32-LT11N 2M | 4,000 *2 | 3,500 | 2,300 | 920 |
| | | 10° | E32-T17L 10M | 20,000 *1 | 20,000 *1 | 20,000 *1 | 8,000 |
| | Top-view | 15° | E32-LT11 2M | 4,000 *2 | 4,000 *2 | 2,700 | 1,080 |
| | | | E32-LT11R 2M | 4,000 *2 | 3,500 | 2,300 | 920 |
| Side-view | 30° | E32-T14 2M | 4,000 *2 | 4,000 *2 | 4,000 *2 | 1,800 | |
| Through-beam models with lenses | Right-angle | 12° | E32-T11N 2M+E39-F1 | 4,000 *2 | 4,000 *2 | 4,000 *2 | 2,000 |
| | | 6° | E32-T11N 2M+E39-F16 | 4,000 *2 | 4,000 *2 | 4,000 *2 | 3,600 |
| | Top-view | 12° | E32-T11R 2M+E39-F1 | 4,000 *2 | 4,000 *2 | 4,000 *2 | 2,000 |
| | | 6° | E32-T11R 2M+E39-F16 | 4,000 *2 | 4,000 *2 | 4,000 *2 | 3,600 |
| | Side-view | 60° | E32-T11R 2M+E39-F2 | 1,450 | 800 | 500 | 200 |
| | Top-view | 12° | E32-T11 2M+E39-F1 | 4,000 *2 | 4,000 *2 | 4,000 *2 | 1,860 |
| | | 6° | E32-T11 2M+E39-F16 | 4,000 *2 | 4,000 *2 | 4,000 *2 | 4,000 *2 |
| | Side-view | 60° | E32-T11 2M+E39-F2 | 2,300 | 1,320 | 860 | 320 |
| | Top-view | 12° | E32-T51R 2M+E39-F1 | 4,000 *2 | 4,000 *2 | 3,900 | 1,500 |
| | | 6° | E32-T51R 2M+E39-F16 | 4,000 *2 | 4,000 *2 | 4,000 *2 | 4,000 *2 |
| | Side-view | 60° | E32-T51R 2M+E39-F2 | 1,400 | 720 | 500 | 200 |
| | Top-view | 12° | E32-T81R-S 2M+E39-F1 | 4,000 *2 | 4,000 *2 | 2,700 | 1,000 |
| | | 6° | E32-T81R-S 2M+E39-F16 | 4,000 *2 | 4,000 *2 | 4,000 *2 | 1,800 |
| | Side-view | 60° | E32-T81R-S 2M+E39-F2 | 1,000 | 550 | 360 | 140 |
| | Top-view | 12° | E32-T61-S 2M+E39-F1 | 4,000 *2 | 4,000 *2 | 4,000 *2 | 1,800 |
| | | 6° | E32-T61-S 2M+E39-F16 | 4,000 *2 | 4,000 *2 | 4,000 *2 | 3,100 |
| Side-view | 60° | E32-T61-S 2M+E39-F2 | 1,680 | 900 | 600 | 240 | |
| Top-view | 12° | E32-T51 2M+E39-F1-33 | 4,000 *2 | 4,000 *2 | 2,300 | 1,400 | |
| | 6° | E32-T51 2M+E39-F16 | 4,000 *2 | 4,000 *2 | 4,000 *2 | 4,000 *2 | |
| Reflective models with integrated lens | Top-view | 4° | E32-D16 2M | 40 to 2,800 | 40 to 1,400 | 40 to 900 | 40 to 480 |

*1. The fiber length is 10 m on each side, so the sensing distance is given as 20,000 mm.

*2. The fiber length is 2 m on each side, so the sensing distance is given as 4,000 mm.

Narrow View Models

| Sensing method | Sensing direction | Aperture angle | Model | Sensing distance (mm) | | | |
|----------------|-------------------|----------------|--------------|-----------------------|---------------|-----------------|-----------------------|
| | | | | Giga mode | Standard mode | High-speed mode | Super-high-speed mode |
| Through-beam | Side-view | 1.5° | E32-A03 2M | 3,220 | 1,780 | 1,200 | 500 |
| | | | E32-A03-1 2M | | | | |
| | | 3.4° | E32-A04 2M | 1,280 | 680 | 450 | 200 |
| | | 4° | E32-T24SR 2M | 4,000 * | 2,200 | 1,460 | 580 |
| | | | E32-T24S 2M | 4,000 * | 2,600 | 1,740 | 700 |
| | E32-T22S 2M | 4,000 * | 3,800 | 2,500 | 1,000 | | |

* The fiber length is 2 m on each side, so the sensing distance is given as 4,000 mm.

Models for Detection without Background Interference

| Sensing method | Sensing direction | Model | Sensing distance (mm) | | | |
|--------------------|-------------------|--------------|-----------------------|---------------|-----------------|-----------------------|
| | | | Giga mode | Standard mode | High-speed mode | Super-high-speed mode |
| Limited-reflective | Flat-view | E32-L16-N 2M | 0 to 15 | | | 0 to 12 |
| | | E32-L24S 2M | 0 to 4 | | | |
| | Side-view | E32-L25L 2M | 5.4 to 9 (center 7.2) | | | |

Transparent Object Detection (Retro-reflective Models)

| Sensing method | Feature | Size | Model | Sensing distance (mm) | | | |
|------------------|----------------|------|-------------------------------------|-----------------------|---------------|-----------------|-----------------------|
| | | | | Giga mode | Standard mode | High-speed mode | Super-high-speed mode |
| Retro-reflective | Film detection | M3 | E32-C31 2M +E39-F3R +E39-RP37 | 250 | | 200 | --- |
| | Square | --- | E32-R16 5M | 150 to 1,500 | | | |
| | Threaded | M6 | E32-R21 2M | 10 to 250 | | | |
| | Hex-shaped | | E32-LR11NP 2M +E39-RP1 | 1,350 | 1,200 | 1,000 | 550 |

Transparent Object Detection (Limited-reflective Models)

| Sensing method | Feature | Sensing direction | Model | Sensing distance (mm) | | | |
|--------------------|---------------------------------|-------------------|--------------|-----------------------|---------------|-----------------|-----------------------|
| | | | | Giga mode | Standard mode | High-speed mode | Super-high-speed mode |
| Limited-reflective | Small size | Flat-view | E32-L24S 2M | 0 to 4 | | | |
| | Standard | | E32-L16-N 2M | 0 to 15 | | 0 to 12 | |
| | Glass substrate alignment, 70°C | | E32-A08 2M | 10 to 20 | | --- | |
| | Standard/long-distance | E32-A12 2M | 12 to 30 | | --- | | |
| | Side-view form | Side-view | E32-L25L 2M | 5.4 to 9 (center 7.2) | | | |
| | Glass substrate mapping, 70°C | Top-view | E32-A09 2M | 15 to 38 | | --- | |

Chemical-resistant, Oil-resistant Models

| Sensing method | Type | Sensing direction | Model | Sensing distance (mm) | | | |
|---------------------------------|---|-------------------|--------------|--|---------------|-----------------|-----------------------|
| | | | | Giga mode | Standard mode | High-speed mode | Super-high-speed mode |
| Through-beam | Oil-resistant | Right-angle | E32-T11NF 2M | 4,000 *1 | 4,000 *1 | 4,000 *1 | 2,200 |
| | Chemical/oil-resistant | Top-view | E32-T12F 2M | 4,000 *1 | 4,000 *1 | 4,000 *1 | 1,600 |
| | | Side-view | E32-T11F 2M | 4,000 *1 | 4,000 *1 | 2,600 | 1,000 |
| | | | E32-T14F 2M | 1,400 | 800 | 500 | 200 |
| Chemical/oil-resistant at 150°C | Top-view | E32-T51F 2M | 4,000 *1 | 2,800 | 1,800 | 700 | |
| Reflective | Semiconductors: Cleaning, developing, and etching; 60°C | Top-view | E32-L11FP 5M | 8 to 20 mm from tip of lens (Recommended sensing distance: 11 mm), 19 to 31 mm from center of mounting hole A (Recommended sensing distance: 22 mm) | | | |
| | Semiconductors: Resist stripping; 85°C | | E32-L11FS 5M | 8 to 20 mm from tip of lens (Recommended sensing distance: 11 mm), 32 to 44 mm from center of mounting hole A (Recommended sensing distance: 35 mm) | | | |
| | Chemical/oil-resistant | | E32-D12F 2M | --- | 190 | 130 | 60 |
| | Chemical-resistant cable | | E32-D11U 2M | 840 | 350 | 240 | 100 |

*1. The fiber length is 2 m on each side, so the sensing distance is given as 4,000 mm.

*2. Even if there is no sensing object, the Sensor will detect light that is reflected by the fluorescein.

Bending-resistant Models

| Sensing method | Size | Model | Sensing distance (mm) | | | |
|----------------|----------|--------------|-----------------------|---------------|-----------------|-----------------------|
| | | | Giga mode | Standard mode | High-speed mode | Super-high-speed mode |
| Through-beam | 1.5 dia. | E32-T22B 2M | 680 | 400 | 220 | 90 |
| | M3 | E32-T21 2M | | | | |
| | M4 | E32-T11 2M | 2,500 | 1,350 | 900 | 360 |
| | Square | E32-T25XB 2M | 500 | 300 | 170 | 70 |
| Reflective | 1.5 dia. | E32-D22B 2M | 140 | 60 | 40 | 16 |
| | M3 | E32-D21 2M | | | | |
| | 3 dia. | E32-D221B 2M | 300 | 140 | 90 | 40 |
| | M4 | E32-D21B 2M | | | | |
| | M6 | E32-D11 2M | 840 | 350 | 240 | 100 |
| | Square | E32-D25XB 2M | 240 | 100 | 60 | 30 |

Heat-resistant Models

| Sensing method | Size | Model | Sensing distance (mm) | | | | |
|----------------|-------|---------------|-----------------------|---------------|-----------------|-----------------------|-----|
| | | | Giga mode | Standard mode | High-speed mode | Super-high-speed mode | |
| Through-beam | 100°C | E32-T51R 2M | 1,600 | 800 | 560 | 225 | |
| | 150°C | E32-T51 2M | 2,800 | 1,500 | 1,000 | 400 | |
| | 200°C | E32-T81R-S 2M | 1,000 | 550 | 360 | 140 | |
| | 350°C | E32-T61-S 2M | 1,680 | 900 | 600 | 240 | |
| Reflective | 100°C | E32-D51R 2M | 670 | 280 | 190 | 80 | |
| | 150°C | E32-D51 2M | 1,120 | 450 | 320 | 144 | |
| | 200°C | E32-D81R-S 2M | 420 | 180 | 120 | 54 | |
| | 300°C | E32-A08H2 2M | 10 to 20 | | | | --- |
| | | E32-A09H2 2M | 20 to 30 (center 25) | | | | --- |
| | 350°C | E32-D611-S 2M | 420 | 180 | 120 | 54 | |
| | | E32-D61-S 2M | | | | | |
| | 400°C | E32-D73-S 2M | 280 | 120 | 80 | 36 | |

Area Detection Models

| Sensing method | Type | Sensing width | Model | Sensing distance (mm) | | | |
|----------------|-------|---------------|--------------|-----------------------|---------------|-----------------|-----------------------|
| | | | | Giga mode | Standard mode | High-speed mode | Super-high-speed mode |
| Through-beam | Area | 11 mm | E32-T16PR 2M | 3,100 | 1,700 | 1,120 | 440 |
| | | | E32-T16JR 2M | 2,750 | 1,500 | 960 | 380 |
| | | 30 mm | E32-T16WR 2M | 4,000 * | 2,600 | 1,700 | 680 |
| Reflective | Array | 11 mm | E32-D36P1 2M | 700 | 300 | 200 | 90 |

* The fiber length is 2 m on each side, so the sensing distance is given as 4,000 mm.

Liquid-level Detection Models

| Sensing method | Tube diameter | Feature | Model | Sensing distance (mm) | | | |
|---|-----------------------|------------------------------------|--------------|--|---------------|-----------------|-----------------------|
| | | | | Giga mode | Standard mode | High-speed mode | Super-high-speed mode |
| Tube-mounting | 3.2, 6.4, or 9.5 dia. | Stable residual quantity detection | E32-A01 5M | Applicable tube: Transparent tube with a diameter of 3.2, 6.4, or 9.5 mm, Recommended wall thickness: 1 mm | | | |
| | 8 to 10 dia. | Mounting at multiple levels | E32-L25T 2M | Applicable tube: Transparent tube with a diameter of 8 to 10 mm, Recommended wall thickness: 1 mm | | | |
| | No restrictions | Large tubes | E32-D36T 5M | Applicable tube: Transparent tube (no restrictions on diameter) | | | |
| Liquid contact (heat-resistant up to 200°C) | --- | --- | E32-D82F1 4M | Liquid-contact type | | | |

Vacuum-resistant Models

| Sensing method | Heat-resistant temperature | Model | Sensing distance (mm) | | | |
|----------------|----------------------------|---------------------|-----------------------|---------------|-----------------|-----------------------|
| | | | Giga mode | Standard mode | High-speed mode | Super-high-speed mode |
| Through-beam | 120°C | E32-T51V 1M | 720 | 400 | 260 | 100 |
| | | E32-T51V 1M+E39-F1V | 2,000 * | 2,000 * | 1,360 | 520 |
| | 200°C | E32-T84SV 1M | 1,760 | 950 | 640 | 260 |

* The fiber length is 1 m on each side, so the sensing distance is given as 2,000 mm.

Models for FPD, Semiconductors, and Solar Cells

| Sensing method | Application | Operating temperature | Model | Sensing distance (mm) | | | |
|--|---------------------------|-----------------------|---|-----------------------|---------------|-----------------|-----------------------|
| | | | | Giga mode | Standard mode | High-speed mode | Super-high-speed mode |
| Limited-reflective | Glass presence detection | 70°C | E32-L16-N 2M | 0 to 15 | | | 0 to 12 |
| | | | E32-A08 2M | 10 to 20 | | | --- |
| | Glass substrate alignment | 300°C | E32-A08H2 3M | 12 to 30 | | | --- |
| | | | E32-A12 2M | 15 to 38 | | | --- |
| | Glass substrate mapping | 300°C | E32-A09 2M | 20 to 30 (center 25) | | | --- |
| | | | E32-A09H2 2M | | | | |
| Wet processes: Cleaning, Resist developing and etching | 60°C | E32-L11FP 5M | 8 to 20 mm from tip of lens (Recommended sensing distance: 11 mm), 19 to 31 mm from center of mounting hole A (Recommended sensing distance: 22 mm) | | | | |
| | | E32-L11FS 5M | 8 to 20 mm from tip of lens (Recommended sensing distance: 11 mm), 32 to 44 mm from center of mounting hole A (Recommended sensing distance: 35 mm) | | | | |
| Through-beam | Wafer mapping | 70°C | E32-A03 2M | 3,220 | 1,780 | 1,200 | 500 |
| | | | E32-A03-1 2M | | | | |
| | | | E32-A04 2M | 1,280 | 680 | 450 | 200 |
| | | | E32-T24SR 2M | 4,000 * | 2,200 | 1,460 | 580 |
| | | | E32-T24S 2M | 4,000 * | 2,600 | 1,740 | 700 |

* The fiber length is 2 m on each side, so the sensing distance is given as 4,000 mm.

I/O Circuit Diagrams

NPN Output

| Models | Operation mode | Timing chart | L/D indicators | Output circuit |
|---------------------------------|----------------|--------------|----------------|---|
| E3X-HD11 E3X-HD6 E3X-HD14 | Light-ON | | L lit. | <p>• M8 Connector Pin Arrangement</p> <p>Note: Pin 2 is not used.</p> |
| | Dark-ON | | D lit. | |

PNP Output

| Models | Operation mode | Timing chart | L/D indicators | Output circuit |
|---------------------------------|----------------|--------------|----------------|---|
| E3X-HD41 E3X-HD8 E3X-HD44 | Light-ON | | L lit. | <p>• M8 Connector Pin Arrangement</p> <p>Note: Pin 2 is not used.</p> |
| | Dark-ON | | D lit. | |

| ON delay | OFF delay | One-shot |
|----------|-----------|----------|
| | | |

Note: Timing Charts for Timer Settings (T: Set Time)

Plug (Sensor I/O Connector)

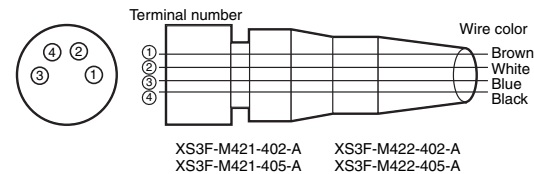

| Wire color | Connection pin | Application |
|------------|----------------|--------------------|
| Brown | 1 | Power supply (+V) |
| White | 2 | --- |
| Blue | 3 | Power supply (0 V) |
| Black | 4 | Output |

Note: Pin 2 is not used.

Nomenclature

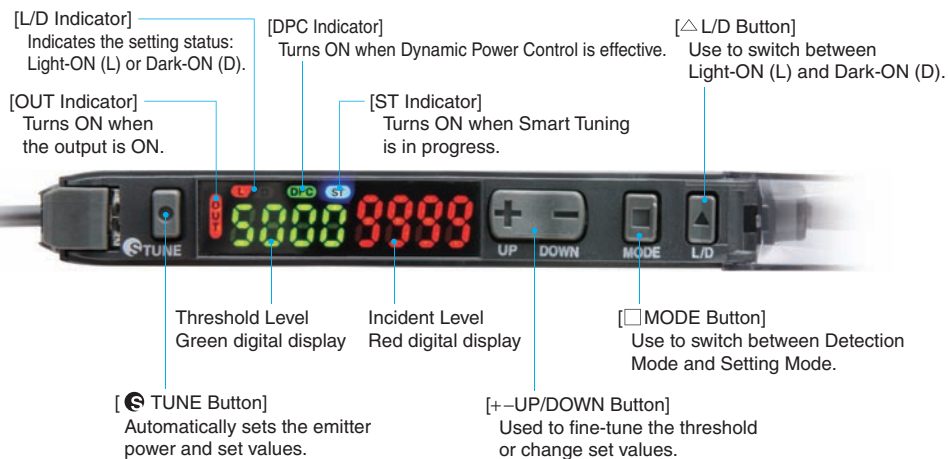

Safety Precautions

Refer to the *Fiber Sensors Technical Guide* for precautions that apply to all Fiber Sensors.

Warning

This product is not designed or rated for ensuring safety of persons either directly or indirectly. Do not use it for such purposes.



Do not use the product with voltage in excess of the rated voltage. Excess voltage may result in malfunction or fire.



Never use the product with AC power supply. Otherwise, explosion may result.



Precautions for Safe Use

The following precautions must be observed to ensure safe operation of the product. Doing so may cause damage or fire.

1. Do not install the product in the following locations.
 - Locations subject to direct sunlight
 - Locations subject to condensation due to high humidity
 - Locations subject to corrosive gas
 - Locations subject to vibration or mechanical shocks exceeding the rated values
 - Locations subject to exposure to water, oil, chemicals
 - Locations subject to stream
 - Locations subjected to strong magnetic field or electric field
2. Do not use the product in environments subject to flammable or explosive gases.
3. To secure the safety of operation and maintenance, do not install the product close to high-voltage devices and power devices.
4. High-Voltage lines and power lines must be wired separately from this product. Wiring them together or placing them in the same duct may cause induction, resulting in malfunction or damage.
5. Do not apply load exceeding the ratings. Otherwise, damage or fire may result.
6. Do not short the load. Otherwise, damage or fire may result.
7. Connect the load correctly.
8. Do not miswire such as the polarity of the power supply.
9. Do not use the product if the case is damaged.
10. Burn injury may occur. The product surface temperature rises depending on application conditions, such as the ambient temperature and the power supply voltage. Attention must be paid during operation or cleaning.
11. When setting the Sensor, be sure to check safety, such as by stopping the equipment.
12. Be sure to turn off the power supply before connecting or disconnecting wires.
13. Do not attempt to disassemble, repair, or modify the product Unit in any way.
14. When disposing of the product, treat it as industrial waste.
15. Do not use the Sensor in water, rainfall, or outdoors.

Precautions for Correct Use

- Be sure to mount the unit to the DIN track until it clicks.
- Use an extension cable with a minimum thickness of 0.3 mm² and less than 100 m long.
- Do not subject the cable to more than the following forces. Pull: 40 N; torque: 0.1 N·m; pressure: 20 N; bending: 29.4 N
- The Sensor is ready to operate 200 ms after the power supply is turned ON.
- When using Amplifier Units with Wire-saving Connectors, attach the protective stickers (provided with E3X-CN-series Connectors) on the unused power pins to prevent electrical shock and short circuiting.

When using Amplifier Units with Connectors for Communications Units, attach the protective caps (provided with E3X-CRT/ECT Sensor Communications Unit).

Amplifier Unit with Wire-saving Connector

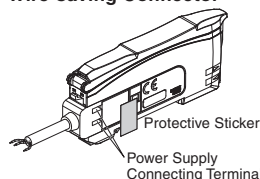

Amplifier Unit with Connector for Communications Unit

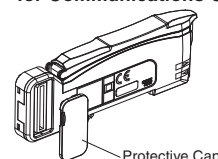

- Output pulses may occur when the power supply is turned OFF. Turn OFF the power supply to the load or load line first.
- Excessive incident light cannot be sufficiently handled by the mutual interference prevention function and may cause malfunction. To prevent this, set a higher threshold level.
- Make sure that the power supply is turned OFF before connecting, separating, or adding Amplifier Units.
- Do not pull on or apply excessive pressure or force to the Fiber Unit when it is attached to the Amplifier Unit.
- The E3X-MC11, E3X-MC11-SV2 and E3X-MC11-S Mobile Consoles cannot be used.
- Mutual interference prevention on the E3X-HD Series does not function among the E3NX-FA, E3X-DA-N, E3X-SD, or E3X-NA Fiber Amplifier Units. Mutual interference prevention on the E3X-HD Series does not function among the E3X-DA-S and E3X-MDA Fiber Amplifier Units.
- The E3X-CRT and E3X-ECT Sensor Communications Unit can be used with the E3X-HD0, but the E3X-DRT21-S and E3NW-ECT Sensor Communications Units cannot be used.
- Always keep the protective cover in place when using the Amplifier Unit.
- Do not use thinner, benzene, acetone, and kerosene for cleaning.

For technical information and product FAQs, refer to the *Technical Guide* on your OMRON website.

Mounting the Fiber Amplifier Units

■ Mounting on DIN Track

1. Let the hook on the Amplifier Unit's Fiber Unit connection side catch the track and push the unit until it clicks.

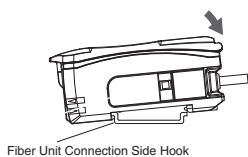

■ Removing from DIN Track

1. Push the unit in the direction 1.
2. Lift it up in the direction 2.

Note: Refer to I/O Circuit Diagrams or check the side of the unit for wire color and role indications.

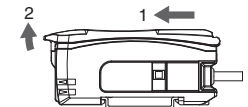

■ Mounting Amplifier Units in Group (Connector Type Models)

1. Mount the Fiber Amplifier units one at a time onto the DIN track and push them until they click.
2. Slide the Fiber Amplifier units in the direction 2.
3. Use End Plates (PFP-M: separately sold) at the both ends of the grouped Fiber Amplifier units to prevent them from separating due to vibration or other cause.
4. Tighten the screw on the End Plates using a driver.

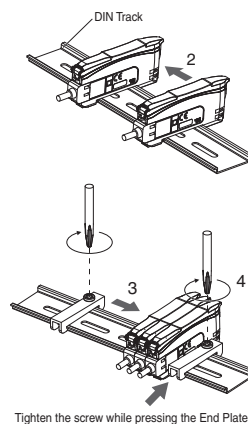

- Under environments such as vibration, use an end plates even with a single Fiber Amplifier Unit.
- The maximum numbers of connectable Amplifier Units are given in the following table.

| | Maximum number of interconnected | Maximum number of mutual interference prevention |
|--|----------------------------------|--|
| E3X-HD series standard models (E3X-HD11/HD41/HD6/HD8) | 16 | 10 |
| E3X-HD0 | With E3X-ECT | 30 |
| | With E3X-CRT | 16 |

- The mutual interference prevention function cannot be used if the detection mode is set to super-high-speed mode (SHS).
- If Units are to be connected, the allowable ambient temperature will change with the number of Units that are connected. Check the Ratings and Specifications.
- Always turn OFF the power before connecting or disconnecting Units.

Mounting Fiber Units

■ Use Fiber Cutter

Cut a thin fiber as follows.
For standard fibers, insert to the desired cutting position and cut.

| | | |
|----|---|---|
| 1. | The fiber is shipped loosely tightened as shown in the figure at the right. | Thin Fiber Attachment (E39-F9) Loosely tighten. |
| 2. | Adjust the fiber to the desired length and fully tighten. | |
| 3. | Insert the Fiber Unit into E39-F4 and cut it. | Fiber Cutter E39-F4 Standard Fiber Unit Hole (dia. 2.2 mm) x 3 Thin-diameter Fiber Unit Hole x 2 |
| 4. | Finished state. (Correctly cut end) | About 0.5 mm Insertion direction Note: The insertion direction into the Fiber Amplifier Unit is shown in the above figure. |

■ Mount Fiber Unit

1. Open the protective cover.
2. Raise the lock lever.
3. Insert the Fiber Unit in the fiber unit hole to the bottom.
4. Return the lock lever to the original position and fix the Fiber Unit.

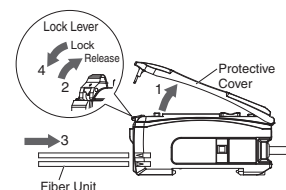

- When mounting a coaxial reflective Fiber Unit, insert the single-core Fiber Unit to the upper hole (Emitter side) and the multi-core Fiber Unit to the lower hole (Receiver side). The cables for the Single-core Fiber Units (Emitters) have identification marks. Refer to the dimensions diagrams for details.

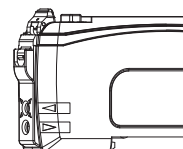

- When removing the Fiber Unit, follow the above steps in reverse order. To maintain the characteristics of the Fiber Unit, make sure the lock is released before removing the Fiber Unit.

Dimensions

Fiber Amplifier Units

Pre-wired Amplifier Units

E3X-HD11

E3X-HD41

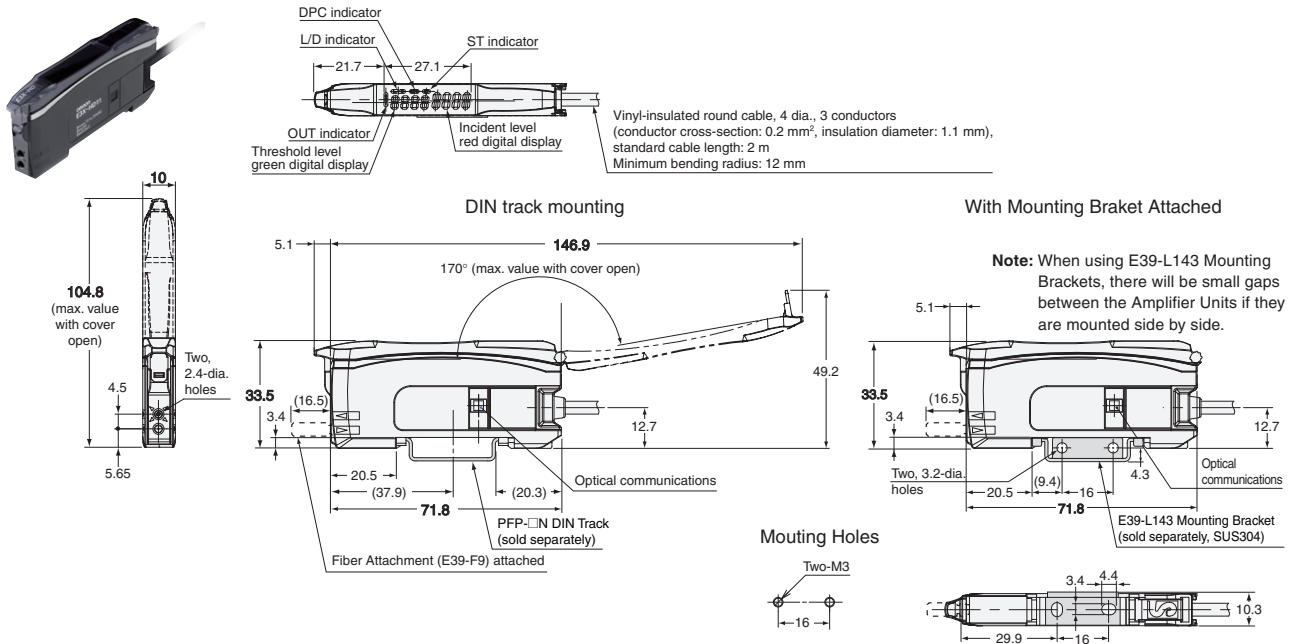

Amplifier Units with Wire-saving Connectors

E3X-HD6

E3X-HD8

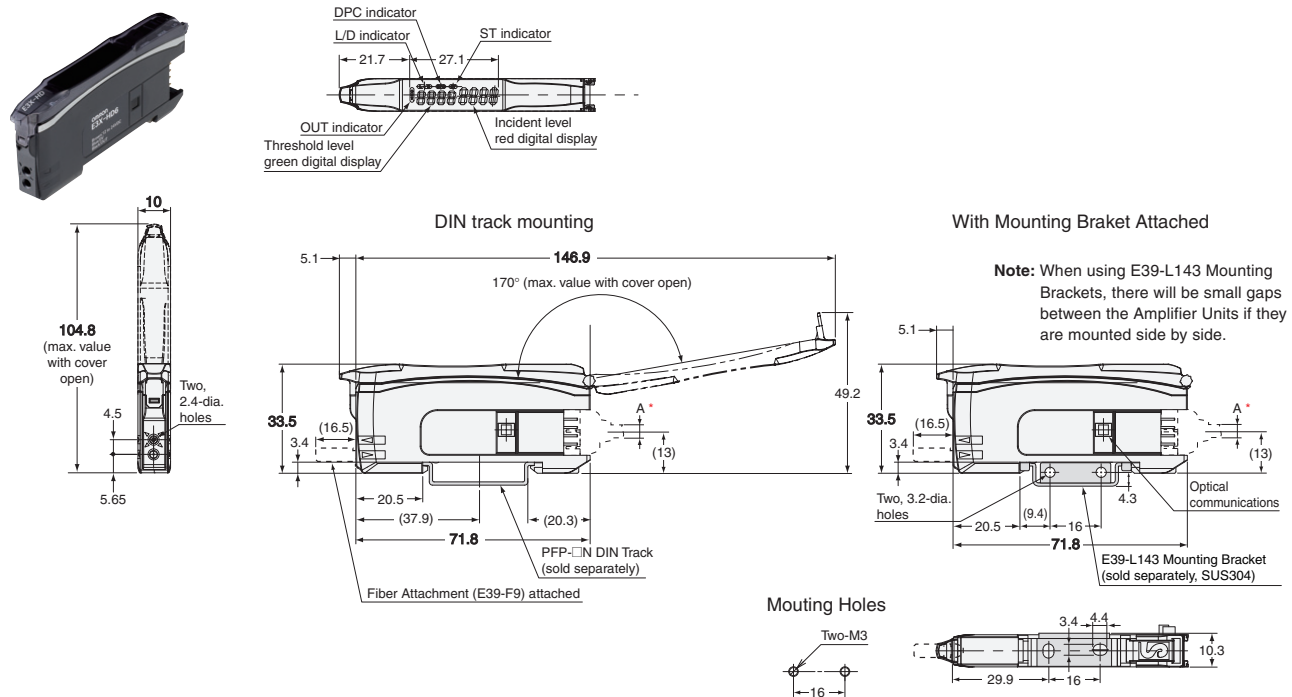

* The cable diameters are as follows:

| | |
|-------------------------|----------|
| E3X-CN11 (3 conductors) | 4.0 dia. |
| E3X-CN12 (1 conductor) | 2.6 dia. |

Amplifier Units with M8 Connectors

E3X-HD14
E3X-HD44

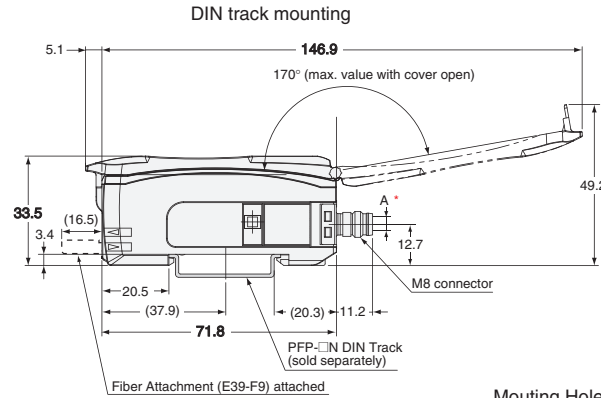
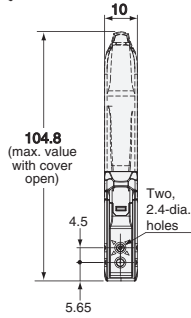
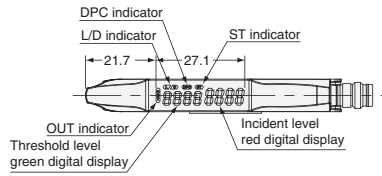

With Mounting Bracket Attached

Note: When using E39-L143 Mounting Brackets, there will be small gaps between the Amplifier Units if they are mounted side by side.

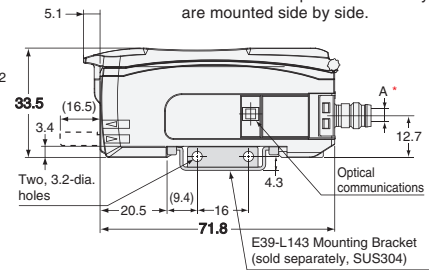

Mounting Holes

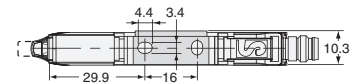

* The cable diameters are as follows:

| | |
|-------------------------|----------|
| E3X-CN11 (3 conductors) | 4.0 dia. |
| E3X-CN12 (1 conductor) | 2.6 dia. |

Amplifier Unit with Connector for Sensor Communications Unit

E3X-HD0

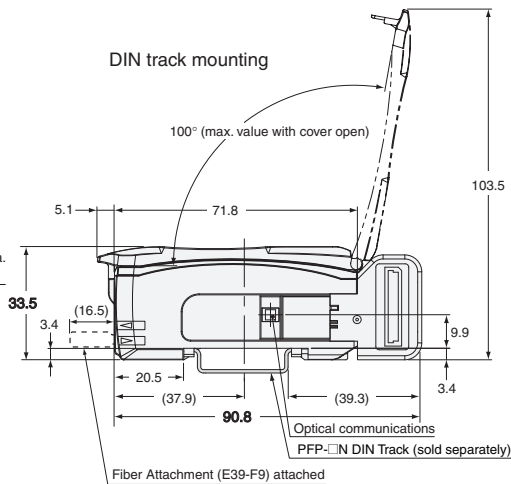
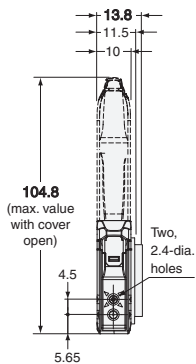
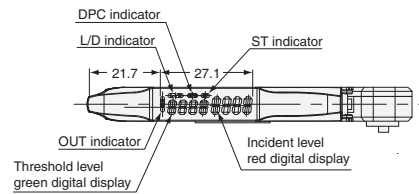

Refer to E32 Series for details on Fiber Units.

Terms and Conditions Agreement

Read and understand this catalog.

Please read and understand this catalog before purchasing the products. Please consult your OMRON representative if you have any questions or comments.

Warranties.

(a) Exclusive Warranty. Omron's exclusive warranty is that the Products will be free from defects in materials and workmanship for a period of twelve months from the date of sale by Omron (or such other period expressed in writing by Omron). Omron disclaims all other warranties, express or implied.

(b) Limitations. OMRON MAKES NO WARRANTY OR REPRESENTATION, EXPRESS OR IMPLIED, ABOUT NON-INFRINGEMENT, MERCHANTABILITY OR FITNESS FOR A PARTICULAR PURPOSE OF THE PRODUCTS. BUYER ACKNOWLEDGES THAT IT ALONE HAS DETERMINED THAT THE PRODUCTS WILL SUITABLY MEET THE REQUIREMENTS OF THEIR INTENDED USE.

Omron further disclaims all warranties and responsibility of any type for claims or expenses based on infringement by the Products or otherwise of any intellectual property right. (c) Buyer Remedy. Omron's sole obligation hereunder shall be, at Omron's election, to (i) replace (in the form originally shipped with Buyer responsible for labor charges for removal or replacement thereof) the non-complying Product, (ii) repair the non-complying Product, or (iii) repay or credit Buyer an amount equal to the purchase price of the non-complying Product; provided that in no event shall Omron be responsible for warranty, repair, indemnity or any other claims or expenses regarding the Products unless Omron's analysis confirms that the Products were properly handled, stored, installed and maintained and not subject to contamination, abuse, misuse or inappropriate modification. Return of any Products by Buyer must be approved in writing by Omron before shipment. Omron Companies shall not be liable for the suitability or unsuitability or the results from the use of Products in combination with any electrical or electronic components, circuits, system assemblies or any other materials or substances or environments. Any advice, recommendations or information given orally or in writing, are not to be construed as an amendment or addition to the above warranty.

See <http://www.omron.com/global/> or contact your Omron representative for published information.

Limitation on Liability: Etc.

OMRON COMPANIES SHALL NOT BE LIABLE FOR SPECIAL, INDIRECT, INCIDENTAL, OR CONSEQUENTIAL DAMAGES, LOSS OF PROFITS OR PRODUCTION OR COMMERCIAL LOSS IN ANY WAY CONNECTED WITH THE PRODUCTS, WHETHER SUCH CLAIM IS BASED IN CONTRACT, WARRANTY, NEGLIGENCE OR STRICT LIABILITY.

Further, in no event shall liability of Omron Companies exceed the individual price of the Product on which liability is asserted.

Suitability of Use.

Omron Companies shall not be responsible for conformity with any standards, codes or regulations which apply to the combination of the Product in the Buyer's application or use of the Product. At Buyer's request, Omron will provide applicable third party certification documents identifying ratings and limitations of use which apply to the Product. This information by itself is not sufficient for a complete determination of the suitability of the Product in combination with the end product, machine, system, or other application or use. Buyer shall be solely responsible for determining appropriateness of the particular Product with respect to Buyer's application, product or system. Buyer shall take application responsibility in all cases.

NEVER USE THE PRODUCT FOR AN APPLICATION INVOLVING SERIOUS RISK TO LIFE OR PROPERTY OR IN LARGE QUANTITIES WITHOUT ENSURING THAT THE SYSTEM AS A WHOLE HAS BEEN DESIGNED TO ADDRESS THE RISKS, AND THAT THE OMRON PRODUCT(S) IS PROPERLY RATED AND INSTALLED FOR THE INTENDED USE WITHIN THE OVERALL EQUIPMENT OR SYSTEM.

Programmable Products.

Omron Companies shall not be responsible for the user's programming of a programmable Product, or any consequence thereof.

Performance Data.

Data presented in Omron Company websites, catalogs and other materials is provided as a guide for the user in determining suitability and does not constitute a warranty. It may represent the result of Omron's test conditions, and the user must correlate it to actual application requirements. Actual performance is subject to the Omron's Warranty and Limitations of Liability.

Change in Specifications.

Product specifications and accessories may be changed at any time based on improvements and other reasons. It is our practice to change part numbers when published ratings or features are changed, or when significant construction changes are made. However, some specifications of the Product may be changed without any notice. When in doubt, special part numbers may be assigned to fix or establish key specifications for your application. Please consult with your Omron's representative at any time to confirm actual specifications of purchased Product.

Errors and Omissions.

Information presented by Omron Companies has been checked and is believed to be accurate; however, no responsibility is assumed for clerical, typographical or proofreading errors or omissions.