

E5ZE-8□-V2
Multipoint Temperature Controller
DeviceNet Communications Model

INSTRUCTION MANUAL

Thank you for purchasing this OMRON product. Please read this instruction sheet and thoroughly familiarize yourself with the functions and characteristics of the product before use. Please retain this sheet for future reference.

OMRON Corporation

©OMRON Corporation 2000 All Rights Reserved 0646129-2A

Refer to the following manuals together with this instruction sheet before operating this product.

- E5ZE Operation Manual (H076)
- E5ZE-8 Operation Manual, DeviceNet Communications (H114)

Refer to the following manuals as well for DeviceNet.

- DeviceNet Operation Manual (W267)

Contact your OMRON representative for the above manuals.

Contents of Package

The following are provided together in the same package. Should any of the following items be missing or damaged, immediately contact your OMRON representatives.

- E5ZE: One
- Mounting brackets: Two (Upper mounting bracket and lower mounting bracket)
- Mounting screws: Four
- Instruction Manual: One
- Set of identification labels: One

Safety Precautions

Definition of Precautionary Information

WARNING
 Indicates information that, if not heeded, could possibly result in loss of life or serious injury.

CAUTION
 Indicates information that, if not heeded, could result in relatively serious or minor injury, damage to the product, or faulty operation.

Warnings

WARNING
 The E5ZE incorporates a lithium battery. Do not disassemble, deform with pressure, heat up to 100°C or more, or burn the E5ZE for disposal. Doing so may cause the battery to catch fire or explode.

CAUTION

- Make sure that the E5ZE in hardware test mode does not affect the operation of any device connected to the E5ZE. Not doing so may cause the device to go into a hazardous condition
- Do not allow metal fragments or lead wire scraps to fall inside this product. These may cause electric shock, fire or malfunction.
- Never disassemble, repair or modify the product. Doing so may cause electric shock, fire or malfunction.
- Tighten the terminal screws to a torque of 0.72 to 0.92 N • m. Loose screws may cause damage or malfunction.
- Correctly set the settings on this product matched to the control target. If the settings are not compatible with the control target, the product might operate in an unexpected manner, resulting in damage to the product or an accident.
- To maintain safety in the event of a product malfunction, we recommend taking safety measures, for example, installing an excessive temperature rise prevention alarm on a separate line. If malfunction prevents control, this may result in a major accident.

NOTICE

Be sure to observe these precautions to ensure safe use.

- Do not wire the terminals that are not used.
- Be sure to wire properly with correct polarity of terminals.
- Allow as much space as possible between the Controller and devices that generate a powerful high-frequency or surge.
- Separate the high-voltage or large-current power lines from other lines, and avoid parallel or common wiring with the power lines when you are wiring to the terminals.
- Do not use the E5ZE in the following locations.
 - Locations with water or oil directly sprayed onto the E5ZE.
 - Locations with dust or corrosive gas.
 - Locations that are excessively humid and where there is a risk of condensation.
 - Locations with vibration or shock directly imposed on the E5ZE.
 - Locations directly exposed to heat radiation from ovens.
 - Locations with radical temperature changes.
 - Locations with a risk of icing or condensation.
- Do not enclose the E5ZE. Make sure that the E5ZE is well ventilated. Do not block the ventilation holes on the Controller.
- Use/store within the rated temperature and humidity ranges.
- Make sure that the rated voltage is attained within two seconds of turning the power ON.
- Make sure the Controller has 30 minutes or more to warm up.
- Use the product within the rated load. Not doing so may cause damage or burning.
- Use the product within the rated supply voltage. Not doing so may cause damage or burning.
- A switch or circuit breaker should be provided close to the Controller. The switch or circuit breaker should be within easy reach of the operator, and must be marked as a disconnecting means for the Controller.

Nomenclature

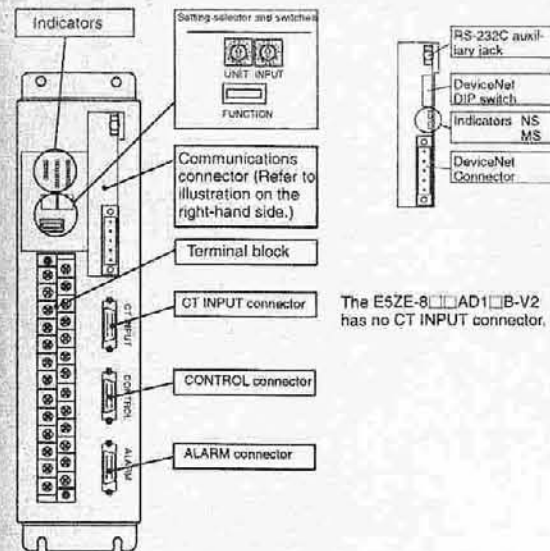

External Dimensions

(All dimensions shown are in millimeters.)

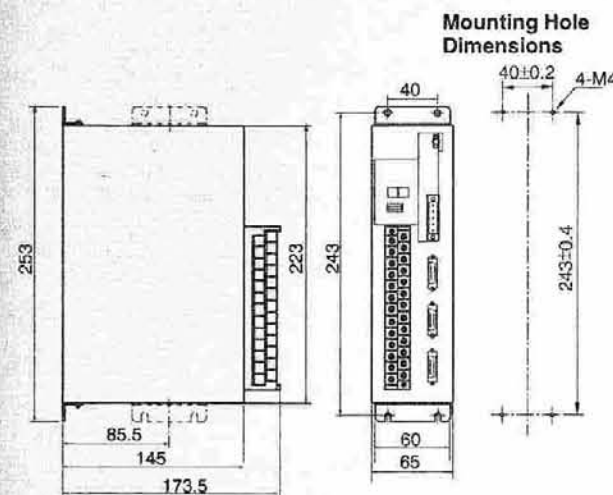

Mounting

- Refer to the above illustrations and mount the E5ZE with the mounting brackets provided.
- Make sure that each screw is tightened to a torque of 0.43 to 0.58 N • m.
- Prepare four M4 screws, flat washers, and spring washers for mounting the E5ZE to control panels.
- The side of the E5ZE with the terminal block or connectors must not face up, otherwise operating errors may result.

Switch and Selector Settings

Switch

- Turn OFF the E5ZE before setting the switches.
- Use a small flat-blade screwdriver to set the switches.
- In the following descriptions, factory settings are marked with asterisks.

INPUT Selector

Set the INPUT selector according to the type of input sensor connected to the E5ZE.



Selector setting	0*	1	2	3	4	5	6	7	8	9	A	B	C	D	E	F
Thermocouple	K	J	R	S	T	E	B	N	L	U	W	PLII	Not used			
Platinum resistance thermometer	Pt 100	JPt 100	Not used													

UNIT Selector



Use the UNIT selector to set a unit number for each E5ZE so that the host system can recognize the E5ZE. Switch settings 0 through F correspond to unit numbers 00 through 0F. The unit number is set to 00 before shipping.

FUNCTION Switch

Use the FUNCTION switch for the following settings.

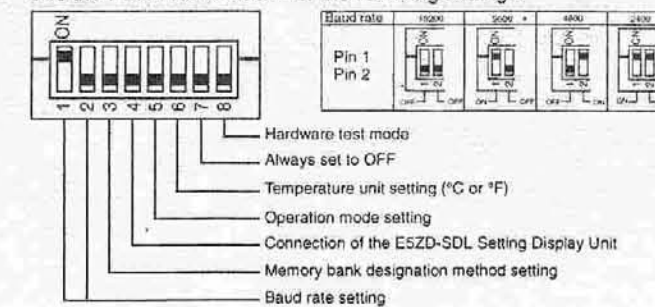

Pin	3	4	5	6	8
Function	Memory bank setting	E5ZD-SDL connection setting	Operation when the power is turned ON	Temperature unit setting	Hardware test mode setting
ON	Contact input	Connected	The status when the power turned OFF continues	°F	Hardware test mode
OFF	Communications*	Not connected*	Operation control stops*	°C*	Operates as Temperature Controller*

Refer to the E5ZE Operation Manual (H076) for the hardware test mode in detail.

DeviceNet DIP Switch Settings

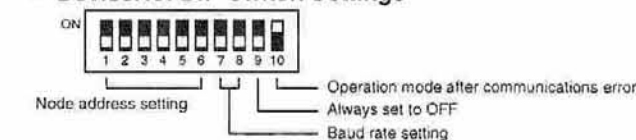

Node Address

Pin 1	Pin 2	Pin 3	Pin 4	Pin 5	Pin 6
2 ⁰	2 ¹	2 ²	2 ³	2 ⁴	2 ⁵

The pins are all set to OFF (node address 00) before shipping.

Pin 10: Communications Error Setting

OFF	Stops operation control.
ON*	Continues operation at the values transmitted before an error occurred.

Baud Rate Setting

Baud rate	Pin 7	Pin 8
125 kbps	OFF*	OFF*
250 kbps	ON	OFF
500 kbps	OFF	ON
Setting prohibited	ON	ON

Indicators

The indicators are lit according to the operation performed as described below.

Indicator	Color	Description
PWR	Green	Lit while power is supplied to the E5ZE.
RDY	Green	Lit when the E5ZE is ready to operate.
ERR	Red	Lit when the Temperature Controller malfunctions.
RUN	Orange	Lit when the E5ZE is in control operation.
AT	Orange	Lit when the E5ZE is in auto-tuning operation.
RD	Orange	Lit while the E5ZE is receiving a command.
SD	Orange	Lit while the E5ZE is transmitting a response.
MB0 to MB2	Orange	Lit when the memory bank designation input is turned ON.
CH0 to CH7 *1	Orange	Lit when control output is turned ON.
H0 to H7 *2	Orange	Lit when heating control output is turned ON.
C0 to C7 *2	Orange	Lit when cooling control output is turned ON.
AL1, AL2	Red	Lit when alarms 1 or 2 output are turned ON.
HB	Red	Lit when HB alarm output is turned ON.
HS	Red	Lit when HS alarm output is turned ON.

Note *1: The CH0 through CH7 indicators are printed on the E5ZE-8A□□D1□B-V2 only.
 *2: The H0 through H7 and C0 through C7 indicators are printed on the E5ZE-8V□□D1□B-V2 only.

The MS and NS indicators are lit according to the status of the DeviceNet as described below.

Indicator	Status	Color	Description
MS	Lit	Green	Normal condition
	Lit	Red	Fatal error
	Flashing		Non-fatal error
	Not lit	---	No power supplied
NS	Lit	Green	Online communications ready
	Flashing		Online communications not ready
	Lit	Red	Fatal communications error
	Flashing		Non-fatal communications error
Not lit	---	Offline/Power turned OFF	

Wiring

- Be sure to turn OFF the E5ZE to wire the terminals
- For the operation of the XW2B-20G4 or XW2B-20G5 Connector-Terminal Conversion Unit, G7VC-O□16 Output Block, and G7TC-OC16 or G7TC-OC08 I/O Block in detail, refer to the relevant datasheets or operation manuals.

Input Terminal Block

The following diagrams show the configurations of the input terminal block.

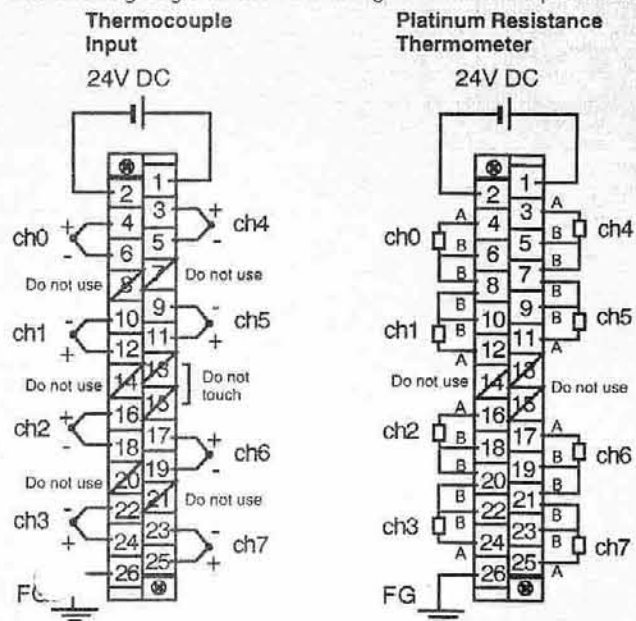

- When connecting or disconnecting the terminal block to or from the E5ZE, loosen or tighten the two mounting screws of the terminal block reciprocally.
- Support the wires connected to the terminal block with an appropriate measure so that the weight of the wires will not be imposed on the terminal block.

- Each terminal screw must be tightened to a torque of 0.82 N·m. Do not tighten any terminal screw to a torque of 0.98 N·m or greater. Doing so may damage the terminal block.

- Process all unused terminals as described below.

Thermocouple Input

Short-circuit each pair of positive and negative terminals.

Platinum Resistance Thermometer Input

Short-circuit each pair of terminals B and connect a 100- to 220-Ω resistor between each pair of terminals A and B as shown in the above diagram.

- When extending the cable of thermocouple input, connect compensating conductors that match the thermocouple used.
- The disconnected terminal block of an E5ZE cannot be connected to other E5ZE with different lot and serial numbers.
- Do not touch terminal 13 or 15 of thermocouple input models.
- Use one of the following solderless terminals according to the screws of the terminal block.

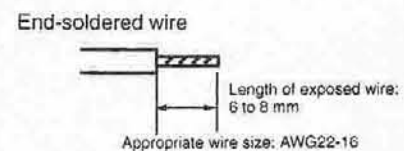
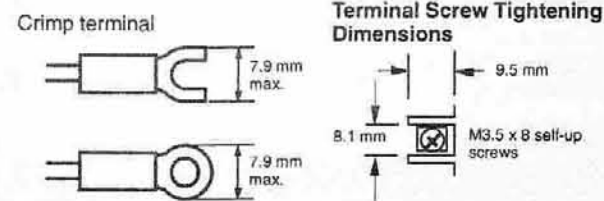

CT Input

- The dedicated E5ZE-CBL□□□ Cable is for connecting the XW2B-20G5 or XW2B-20G4 Terminal Block to the CT INPUT connector.
- The following shows the terminal arrangement of the CT INPUT connector.
- Use the E53-CT1 or E53-CT3 Current Transformer.

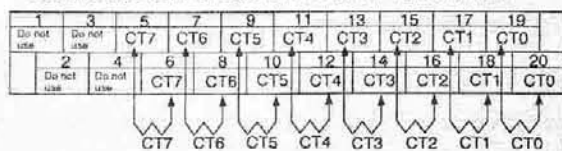

Control Output (Heating Control Output) and Memory Bank Designation Input

- The dedicated E5ZE-CBL□□□ Cable is used for connecting the XW2B-20G5 or XW2B-20G4 Terminal Block to the CONTROL connector.
- The following shows the terminal arrangement of the CONTROL connector.

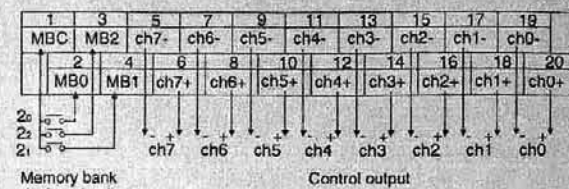

- Wire the memory bank designation input terminal as shown below.

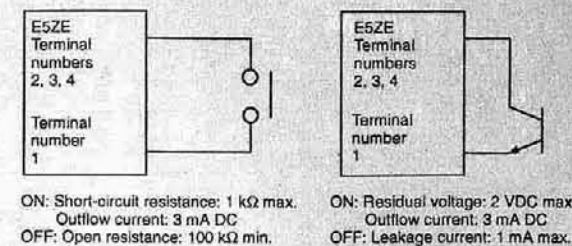

Alarm Output and Cooling Control Output

- The dedicated E5ZE-CBL□□□ Cable is used for connecting the XW2B-20G5 or XW2B-20G4 Terminal Block, G7TC-OC16 or G7TC-OC08 I/O Block, or G7VC-O□16 Output Block to the ALARM connector.
- The following shows the terminal arrangements of the ALARM Connector.

XW2B-20G5 or XW2B-20G4

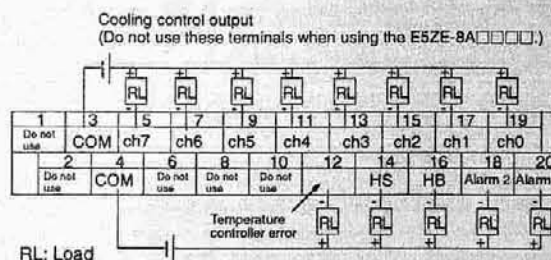

G7TC-OC16 or G7TC-OC08

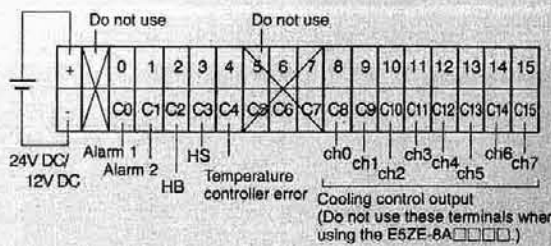
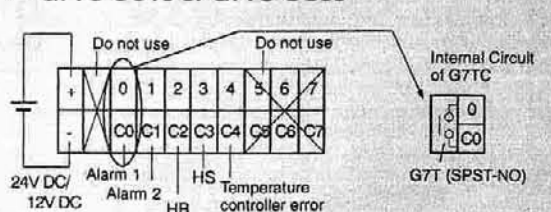

G7VC-O□16

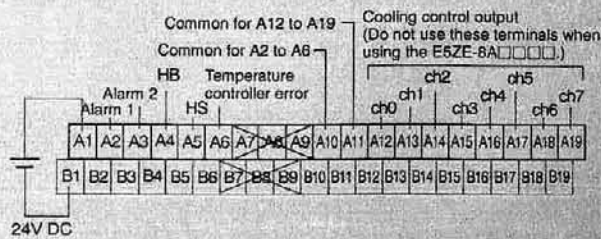

Connection of Relay Load

- When connecting a relay load to the E5ZE, insert a diode between the control output terminals to prevent the E5ZE from malfunctioning due to a surge.

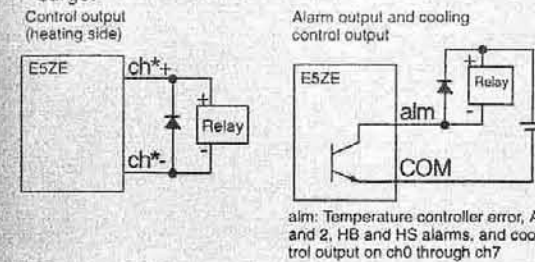

alm: Temperature controller error, Alarms 1 and 2, HB and HS alarms, and cooling control output on ch0 through ch7

Identification Labels

- An E5ZE-CBL□□□ Cable is connected to each CT INPUT connector, CONTROL connector, and ALARM connector. Use the identification labels provided with the E5ZE to identify these connectors by affixing the labels to the connectors as shown below.

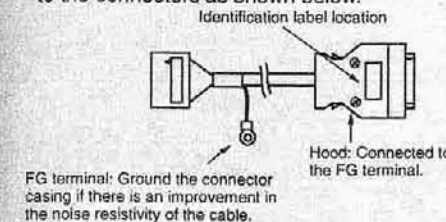

FG terminal: Ground the connector casing if there is an improvement in the noise resistivity of the cable.

Communications

- DeviceNet

Wire the DeviceNet connector as shown here.

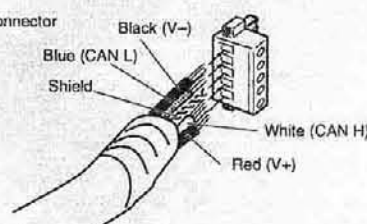

RS-232C Auxiliary Jack

- Connect the following dedicated cable to the RS-232C jack. ES100-CT021-202 (25 pins) for the E5ZD-SDL Setting Display Unit ES100-CT023-202 (9 pins)
- The RS-232C auxiliary jack is for temporary use during initial settings or maintenance. Do not use this jack as a permanent connection when the E5ZE is mounted to equipment. The jack will not maintain a highly reliable contact condition if the jack is continuously connected over a long period.

Specifications

Power supply voltage	24 VDC
Allowable power supply range	85% to 110% of rated voltage
Power consumption	15W + 20% max. at rated voltage
Input sensor	Thermocouple: K, J, R, S, T, E, B, N, L, U, W, PL II Platinum resistance thermometer: Pt100, JPt100 (Rated platinum resistance thermometer current: 1 mA)
CT input	E54-CT1 or E54-CT3 Measurement unit: 0.1 A
Maximum heater current	50 A (AC) at single phase
Control output	Voltage output (with short-circuit protecting function) ON: 12 ± 1.2 VDC OFF: 0.5 VDC max. Max. load current: 30 mA DC per point Current output Rated output range: 4 +0/-0.6 to 20 +2/-0 mA DC Max. load resistance: 600 Ω per point
Cooling control output	Cooling output: 8 points
Alarm output	Temperature alarm: Total output of all control points (alarm 1 NPN open collector output and alarm 2 NPN open collector output) HB alarm (heater burnout detection): Total output of all control points (1-point NPN open collector output) HS alarm (SSR failure detection): Total output of all control points (1-point NPN open collector output) Temperature controller error output (memory, set value, or hardware error): 1-point NPN open collector output Max. voltage imposition: 30 VDC Max. load current: 50 mA DC ON residual voltage: 2 VDC max. OFF leakage current: 1 mA DC max.
Memory bank designation input	With contact signal input ON short-circuit resistance: 1 kΩ max. OFF open resistance: 100 kΩ min. With no-contact signal input ON residual voltage: 2 VDC max. OFF leakage current: 1 mA DC max.

No. of input control points	8 input and 8 control points, and 3 memory bank designation inputs
Setting method	Through communications
Indication method	No designation. Process values are output through communications.
Output operation	Normal and inverted operation
Adjustment mode	ON/OFF control Hybrid of advanced PID control and fuzzy control Manual operation
Auto-tuning	Limit cycle method
Ambient operating temperature	0°C to 55°C (with no icing or condensation)
Ambient operating humidity	35% to 85%
Ambient storage temperature	-25°C to 65°C (with no icing or condensation)
Ambient storage humidity	35% to 95%
Insulation resistance	20 MΩ min. between the FG terminal and all input terminals (at 500 VDC)
Dielectric strength	500 VAC for 1 min between the FG terminal and all input terminals
Vibration resistance	Malfunition: 10 to 55 Hz, 15 m/s ² for 8 min each in X, Y, and Z directions Destruction: 10 to 55 Hz, 20 m/s ² for 8 min each in X, Y, and Z directions
Shock resistance	Malfunition: 150 m/s ² 3 times each in 6 directions Destruction: 200 m/s ² 3 times each in 6 directions
Enclosure rating	IP00
Dimensions	173.5 x 253 x 65 mm
Set value backup	Lithium battery: 10 years min. provided that the ambient temperature is within the normal room temperature
Weight	With casing: Approx. 1,700 g (including 2 mounting brackets)
Power-on standby period	5 s max.

DeviceNet Communications Specifications

Power supply voltage	24 VDC
Allowable power supply range	11 to 25 VDC (supplied through the communications connector)
Power consumption	45 mA max. at 24 VDC

PRECAUTIONS IN USING THE PRODUCT

When the product is used under the circumstances or environment below, ensure adherence to limitations of the ratings and functions. Also, take countermeasures for safety precautions such as fail-safe installations.

- Use under circumstances or environments which are not described in this user's manual.
- Use for nuclear power control, railway, air craft, vehicle, incinerator, medical equipment, entertainment equipment, safety device, etc.
- Use for applications where death or serious property damage is possible and extensive safety precautions are required.

OMRON

OMRON ELECTRONICS, INC.
Phone: (1)847-843-7900

OMRON CANADA INC.
Phone: (1)416-286-6465
Phone: (1)514-636-6676 (French Language)

OMRON EUROPE B.V.
Phone: (31)2356-81-300
Fax: (31)2356-81-388

OMRON ASIAPACIFIC PTE. LTD.
Phone: (65)835-3011

Note: Specifications subject to change without notice.

Printed in Japan