

About this Manual:

This guide describes the installation and startup procedures of the Servo System so that it can be efficiently put in actual operation in a short time.

This guide provides detailed descriptions of key points for efficiently starting up the Servo System as follows:

- Check the wiring by efficiently using the monitor function.
- Perform gain adjustments properly.
- Find the causes of alarms quickly and take the appropriate countermeasures.
- Take appropriate countermeasures for position deviation that might be caused by noise.

This guide applies to the following OMRON products:

- OMNUC U Series
- OMNUC H Series
- OMNUC M Series
- OMNUC R Series

It is recommended that the following manuals be referred to when actually performing the work.

Item	Catalog No.	Model
OMNUC U Series	I501	R88D-UA Analog Input with Power Supply
	I502	R88D-UP Pulse-train Input with Power Supply
OMNUC H Series	I508	R88D-HT/HS
OMNUC M Series	I511	R88D-MT
OMNUC R Series	I503	R88D-RA Analog Input with Power Supply
	I505	R88D-RP Pulse-train Input with Power Supply
	I504	R88D-RB Analog Input without Power Supply
	I506	R88D-RR Pulse-train Input without Power Supply

Finally, please read this guide carefully and be sure you understand the information provided before attempting to install and startup the Servo System. The guide includes the sections described below.

Chapter 1 provides a summary of the Servo System and all gains used for the Servo System loops.

Chapter 2 describes wiring checks, possible system startup errors, and countermeasures against position deviation when constructing the Servo System.

Chapter 3 describes the probable causes of Servo Driver alarms that may occur and the countermeasures required to deal with them.

Chapter 4 describes the types and generation of noise and provides countermeasures against noise.

The **Appendix** provides an example of the configuration of the Servo Driver's main circuitry.

 **WARNING** Failure to read and understand the information provided in this manual may result in personal injury or death, damage to the product, or product failure. Please read each section in its entirety and be sure you understand the information provided in the section and related sections before attempting any of the procedures or operations given.

© **OMRON, 1997**

All rights reserved. No part of this publication may be reproduced, stored in a retrieval system, or transmitted, in any form, or by any means, mechanical, electronic, photocopying, recording, or otherwise, without the prior written permission of OMRON.

No patent liability is assumed with respect to the use of the information contained herein. Moreover, because OMRON is constantly striving to improve its high-quality products, the information contained in this manual is subject to change without notice. Every precaution has been taken in the preparation of this manual. Nevertheless, OMRON assumes no responsibility for errors or omissions. Neither is any liability assumed for damages resulting from the use of the information contained in this publication.

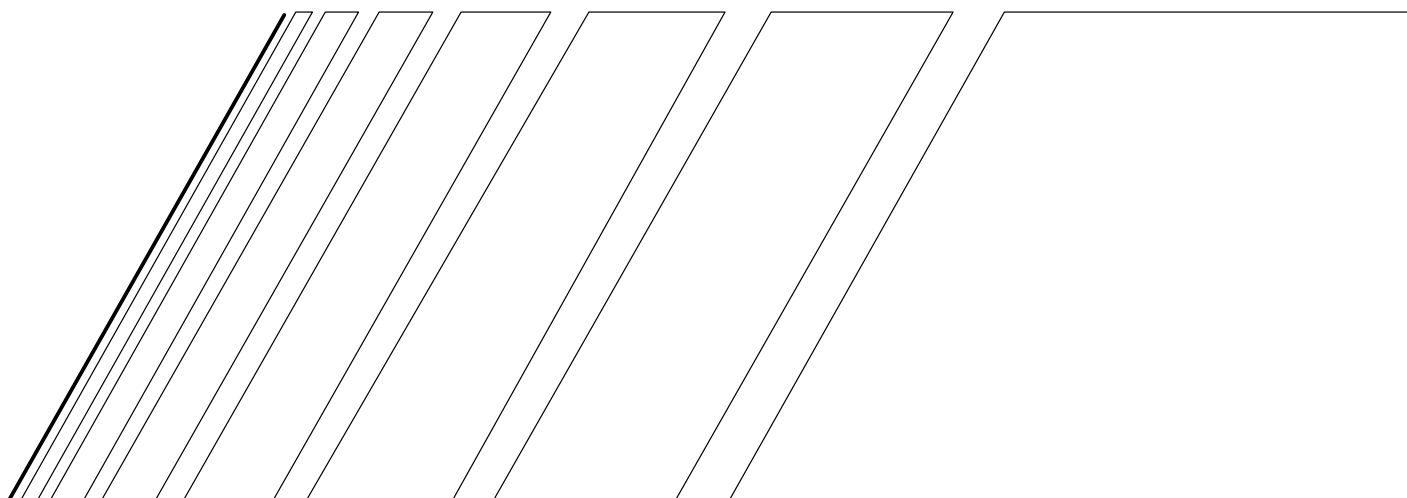

TECHNICAL GUIDE

Servo System Startup

Table of Contents

Chapter 1. Gain Adjustment	1-1
1-1 Types and Meanings of Gain	1-2
1-1-1 Summary of Servo System	1-2
1-1-2 Gain	1-3
1-1-3 Types of Gains	1-4
1-2 Gain Adjustment	1-5
1-2-1 Gain Adjustment Procedure	1-5
1-2-2 Relationship between Gain Adjustment and Response	1-5
1-3 Special Adjustment Parameters	1-10
Chapter 2. Connection to Position Control Unit	2-1
2-1 Wiring Check	2-2
2-1-1 Wiring Check with I/O Monitor	2-2
2-1-2 Wiring Check without I/O Monitor	2-3
2-2 System Startup Errors	2-4
2-3 Countermeasures Against Position Deviation	2-9
Chapter 3. Servo Driver Errors	3-1
3-1 Alarms and Countermeasures	3-2
Chapter 4. Countermeasures Against Noise	4-1
4-1 Generation and Types of Noise	4-2
4-1-1 Noise	4-2
4-1-2 Types of Noise	4-2
4-1-3 Noise Transmission Paths	4-3
4-2 Noise Suppression	4-6
4-2-1 Countermeasures	4-6
4-2-2 Practical Noise Suppression	4-6
4-2-3 Other Countermeasures	4-8
4-2-4 Noise Suppression Example	4-10
Chapter 5. Appendix	5-1
5-1 Configuration of Main Circuitry	5-2
Revision History	R-1

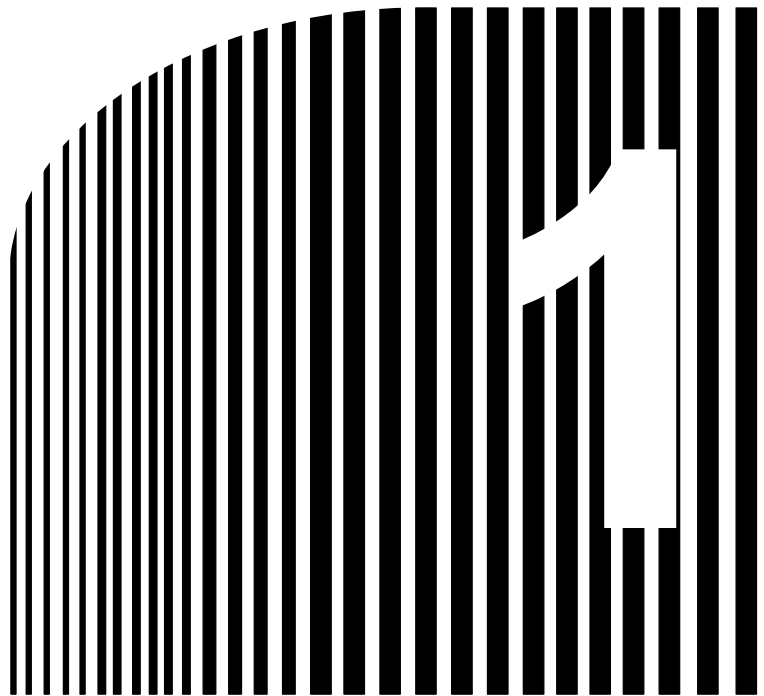

Chapter 1

• Gain Adjustment •

- 1-1 Types and Meanings of Gain
- 1-2 Gain Adjustment
- 1-3 Special Adjustment Parameters

1-1 Types and Meanings of Gain

The word “gain” appears frequently in this technical guide. The gain is one of the indispensable parameters of the Servo System. If the gain adjustment of the Servo System is insufficient, the operation of the Servo System will be unsatisfactory, in which case the Servo System will cause machinery vibration and an alarm will result. A summary of the Servo System and all gains used for the Servo System loops are described below.

1-1-1 Summary of Servo System

The Servo System uses feedback loops. In a feedback loop, the response value is fed back after the command so that the difference between the response and command values will be as close as possible to zero. The Servo System consists of three feedback loops (i.e., position loop, speed loop, and current loop). Refer to the following block diagram.

Position Loop

- The position loop is used to let the rotation angle of the motor reach the desired position (i.e., the desired rotation angle) that was externally designated.
- The speed command is output from the position loop to the speed loop.
- The position loop feeds back the position data (i.e., the information on rotation angle) of the encoder or resolver.

Speed Loop

- The speed loop is used to let the motor rotate at the speed designated by the external analog speed command or the speed command that is output from the position loop.
- The current command is output from the speed loop to the current loop.
- The speed loop feeds back the speed data of the encoder or resolver.

Current Loop

- The current loop provides the motor with the current designated by the current command that is output from the speed loop.
- The current loop feeds back the motor current value.

The gain is a parameter to adjust the response speed of a feedback loop.

Configuration Example of Servo System

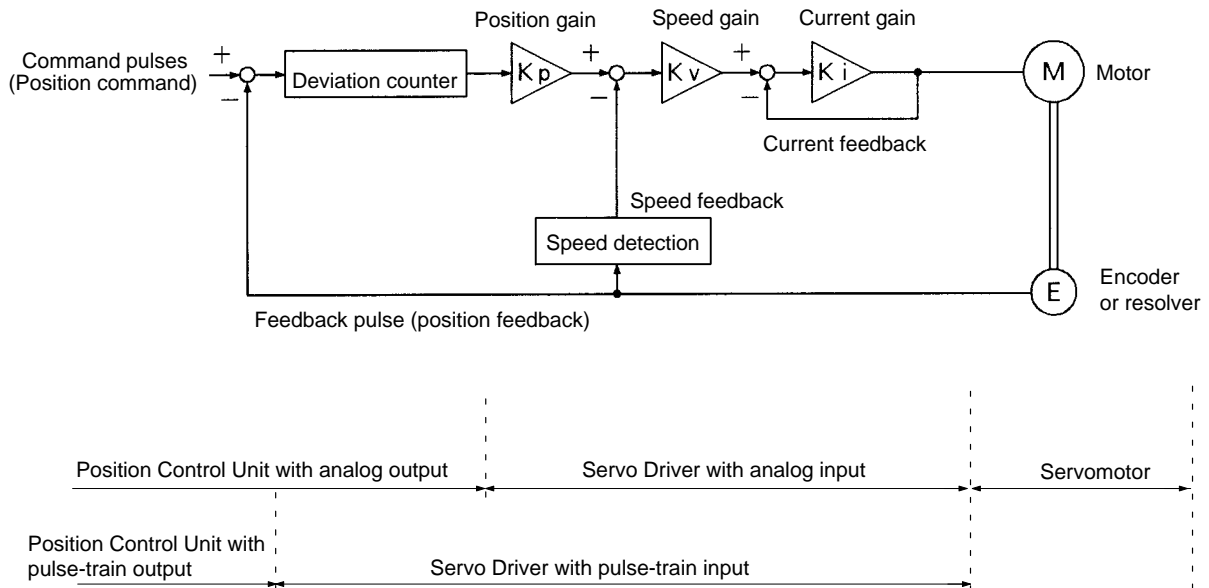

1-1-2 Gain

The gain is another word for magnification.

The difference between the command and response values in a feedback loop is multiplied by the gain and the result is output from the feedback loop. The difference between the target position and present position in the position loop, for example, is obtained as a position deviation or deviation counter value. The value multiplied by the position loop proportional gain is output as a speed command.

In the actual Servo System, the target position is expressed by command pulses and the present position is expressed by feedback pulses, both from which the position deviation per time unit is calculated. The deviation counter totals all the per-time-unit position deviations to obtain the position deviation of the Servo System.

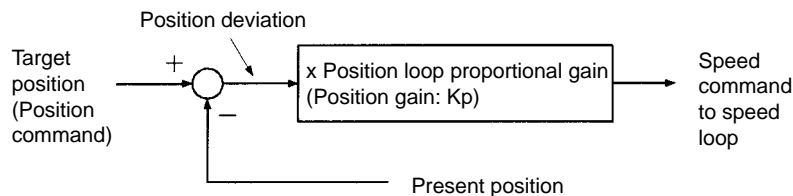

The higher the gain of any feedback loop is, the higher the output of the feedback loop is. In other words, if the gain increases, the output power to fix the deviation will increase. The Servo System with high gains is ideal because the gains ensure a high response speed and reduce errors. If the gains are too high, however, the Servo System will cause machine vibration according to the size and rigidity of the machine system. The Servo System, therefore, requires gain adjustment according to the machine system.

Note Rigidity indicates the engagement strength of the machine system. The backlash or spring portion of a machine system reduces the rigidity of the machine system.

1-1-3 Types of Gains

The following table describes gains and adjustment parameters that will improve the response characteristics of the Servo System.

Gain and adjustment parameter	Function	Parameter name for each series
Current loop command filter	The current (torque) response speed will change by adjusting this gain. Adjust this gain if the Servo System does not stop causing machine vibration after other gains are adjusted. There is no need to adjust this gain in normal operation.	U: Torque command filter time constant H: --- M: Current command filter time constant R: High-range filter frequency selection (Only for models with independent power supplies)
Speed loop proportional gain	The response characteristics of the Servo System in accelerating or decelerating operation will change by adjusting this gain. Adjust this gain to suppress the overshooting or undershooting of the Servo System and improve the response characteristics of the Servo System.	U: Speed loop gain H: Speed loop proportional gain M: Inertia ratio R: AC gain (See note 1)
Speed loop integral gain	The response characteristics of the Servo System in slow operation will change by adjusting this gain. Use this gain to adjust the servo-lock strength of the Servo System.	U: Speed loop integral time constant (See note 2) H: Speed loop integral gain M: Speed gain R: AC gain
Position loop proportional gain	The positioning time of the Servo System will change by adjusting this gain. Adjust this gain to suppress the overshooting or undershooting of the Servo System and minimize the positioning time.	U: Position loop gain H: Position loop proportional gain M: Position gain R: Loop gain (Only for models with pulse-train input)

Note 1. The AC gain of the R Series varies the speed loop proportional gain and speed loop integral gain simultaneously. For details, refer to *1-3 Special Adjustment Parameters*.

Note 2. The integral gain of the speed loop of the U Series is adjusted with the speed loop integral time constant. (Speed loop integral gain \propto 1/Speed loop integral time constant)

1-2 Gain Adjustment

Gain adjustment is indispensable to the functionality of the Servo System. If the gain adjustment of the Servo System is insufficient, the performance of the Servo System will be unsatisfactory and the Servo System will therefore cause machine vibration or not ensure precise positioning. Adjust the current loop, speed loop, and position loop gains of the Servo System in this order. The current loop is, however, adjusted before shipping. The user, therefore, need not adjust any parameter of the current loop.

1-2-1 Gain Adjustment Procedure

The following describes the gain adjustment procedure for the Servo System.

1. Speed Loop Adjustment

- Speed loop proportional gain
- Speed loop integral gain (Speed loop integral time constant)
- Current loop command filter

Basic adjustments of the Servo System are possible with the proportional and integral gains only, in which case however, the machine system may not stop vibrating or may have a slow positioning operation due to insufficient gains. If the machine system has a slow positioning operation or does not stop vibrating, adjust the filter time constant of the current loop.

2. Position Loop Adjustment

- Position loop proportional gain

This gain adjustment is required only for pulse-train input and is irrelevant to analog input.

1-2-2 Relationship between Gain Adjustment and Response

■ Speed Loop Adjustment

The following graph indicates how the response characteristics (i.e., the frequency characteristics) of the Servo System will vary with changes in the speed loop gain and adjustment parameter value.

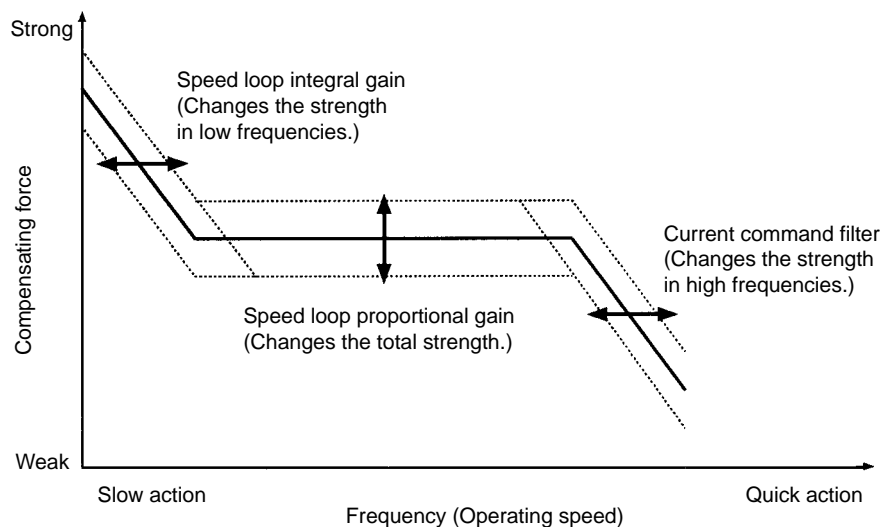

In the above graph, the X axis indicates frequency (movement speed) and the Y axis indicates compensating force for reducing the difference between the response and command as much as possible.

● **Speed Loop Proportional Gain**

- The response characteristics of the Servo System in all frequency bands change by adjusting this gain.
- The compensating force and response characteristics rise if the gain increases.
- Increase the gain as much as possible provided that the adjusted gain does not cause machinery vibration.

● **Speed Loop Integral Gain**

- The response characteristics of the Servo System in low frequencies change by adjusting this gain.
- The servo-lock force rises if the gain increases.
- Increase the gain as much as possible provided that the adjusted gain does not cause machine vibration.

In the case of the U Series, decrease the value of the speed loop integral time constant.

● **Current Command Filter**

- The response characteristics of the Servo System in high frequencies change by adjusting this gain.
- If the value of the filter time constant is large, command changes will be made less extreme and will then be provided to the current loop.
- The adjustment of the current comment filter will be effective if machinery vibration does not stop with the adjustment of the speed loop proportional gain and integral gain.

Adjustment Example 1

- Refer to the following for the normal adjustment of the Servo System that will not require any adjustment of the current command filter to stop machine vibration (i.e., the current command filter is used with factory settings).
- Adjust the proportional gain first, and then the integral gain.

Before Adjustment

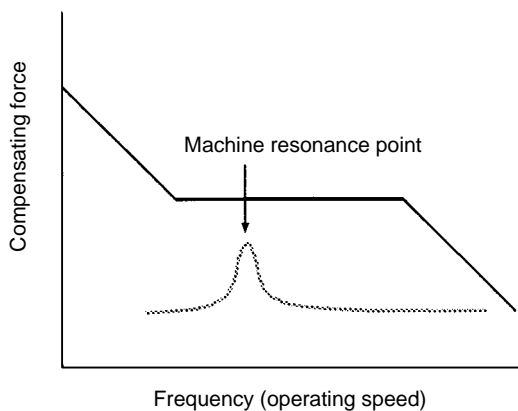

After adjustment

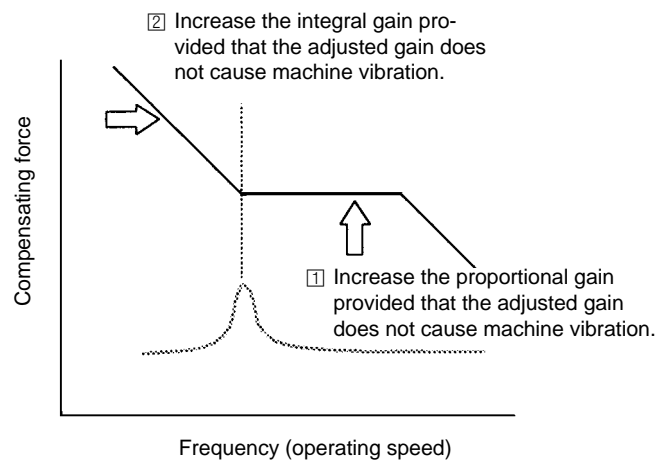

Adjustment Example 2

- Refer to the following for the adjustment of the Servo System that has a strong machine resonance point in a high-frequency band. In this condition, the motor may continue buzzing or vibrate at high frequency if the gains are low.
- Adjust the current command filter time constant, proportional gain, and integral gain in this order. The resonance of the Servo System with the machine system can be avoided by increasing the value of the current command filter time constant. Then adjust the other gains in the usual way.

Before Adjustment

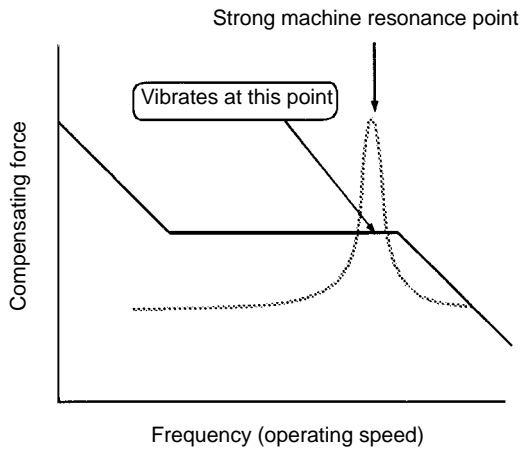

After adjustment

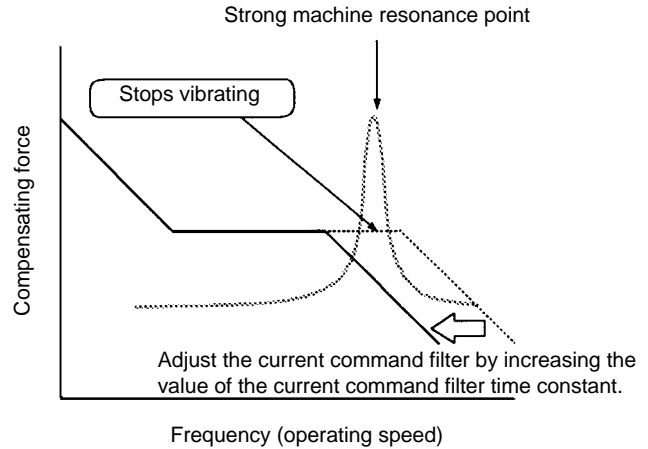

Adjustment Example 3

- Refer to the following for the adjustment of the Servo System that has a strong machine resonance point in a low-frequency band. In this condition, the motor may vibrate at low frequency if the gains are low.
- Adjust the proportional gain and then integral gain. To avoid the resonance of the Servo System with the machine system, decrease the value of the proportional gain. Then adjust the integral gain so that the Servo System can maintain necessary response speed.

Before Adjustment

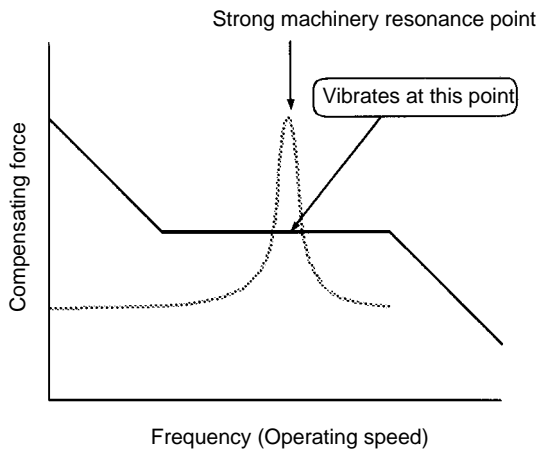

After adjustment

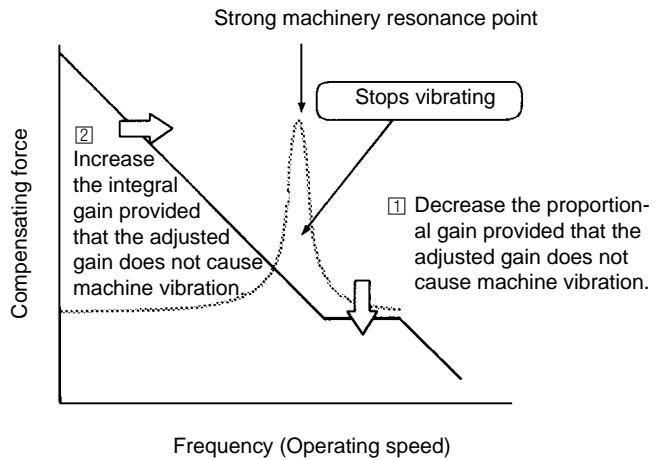

Response Speed Change vs. Speed Loop Adjustment

The following graph indicates how the response characteristics of the Servo System will vary with the changes in the speed loop gain and adjustment parameter value.

Speed Loop Proportional Gain vs. Response Characteristics

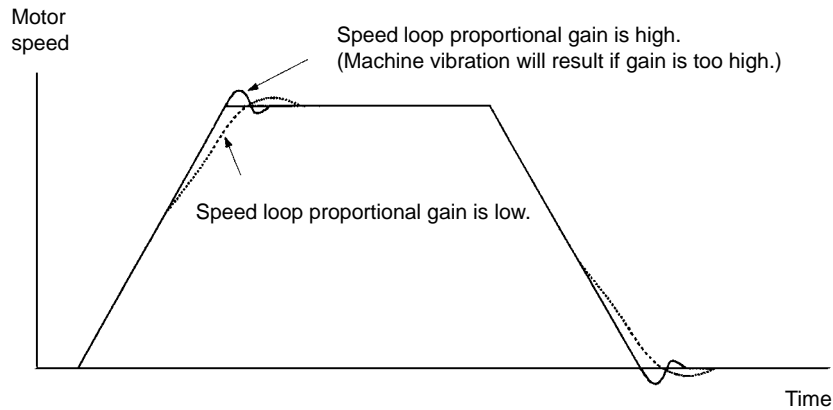

Speed Loop Integral Gain vs. Response Characteristics

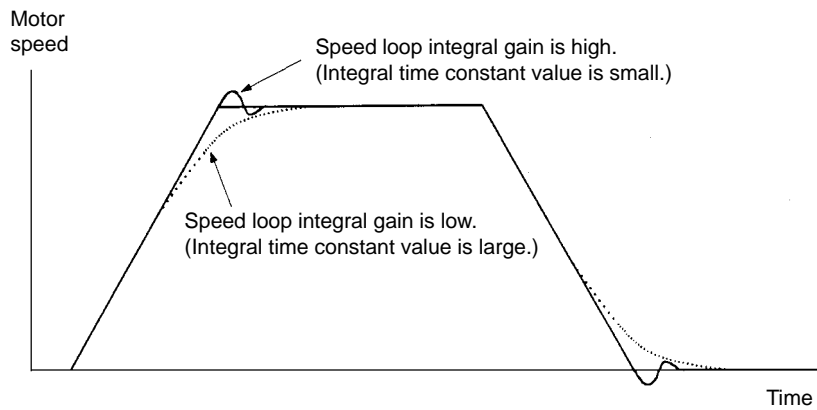

■ Position Loop Adjustment

- Adjust the position loop after adjusting the speed loop.
- Good response characteristics are obtained by increasing the position loop proportional gain provided that the overshooting or undershooting of the Servo System does not result.

Position Loop Proportional Gain vs. Response Characteristics

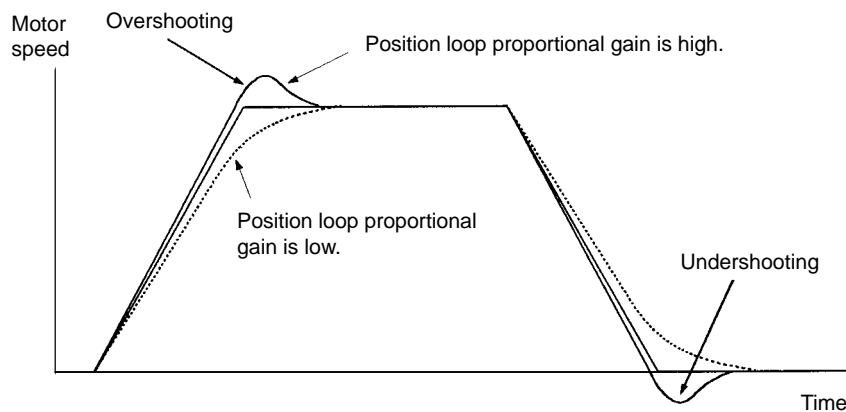

- Overshooting and undershooting can be easily checked by checking the output voltage of the NM terminal with an oscilloscope.

- If an oscilloscope is not available, visually inspect the operation of the motor shaft or machine system. If there is undershooting, the shaft will perform positioning in the opposite direction of the rotating direction before the shaft stops as shown in the following illustration.

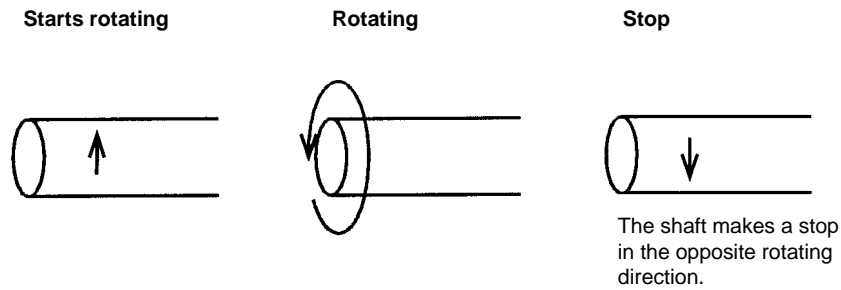

- The amount of overshooting or undershooting varies with the rotational speed of the motor. Usually, the higher the rotational speed is, the greater the overshooting or undershooting is. Therefore, it is recommended that the Servo System be adjusted for the top rotation speed.

1-3 Special Adjustment Parameters

Gains and adjustment parameters for all OMRON Servo Drivers are described below. The auto-tuning function incorporated by the U Series allows easy automatic gain adjustment according to the machine system.

■ Auto-tuning Function (U Series)

- The auto-tuning function allows automatic gain adjustment according to the load while operating the machine system.
- The ideal adjustment according to the rigidity of the machine system will be possible by just selecting the response characteristics if the auto-tuning function is used. It is thus recommended that this function be used as much as possible.
- The auto-tuning function is available to all machine systems except the following, which may require manual adjustment.

Machine systems with heavy friction

Machine system with low rigidity

■ Semi-auto-tuning Function (H Series)

- The semi-auto-tuning function makes it possible to adjust the speed loop proportional gain and integral gain by just setting the load inertia ratio to the rotor inertia ratio of the motor.
- The most suitable gain according to the inertia ratio is preset as a table.
- Manual adjustment is required for machine systems with heavy friction or low rigidity.
- The position loop requires adjustment according to the machine system. The semi-auto-tuning function does not perform position loop adjustment.

■ AC Gain (R Series)

- The AC gain is used to adjust the speed loop proportional gain and integral gain simultaneously.
- The ratio of the proportional gain to integral gain is fixed.

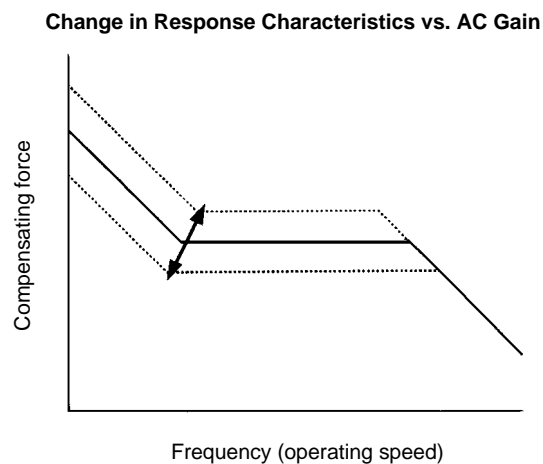

■ Feed-forward Function (U Series: Feed-forward Value; H Series: Position Loop Feed-forward Gain)

- The feed-forward function is enabled at the time of pulse-train input.
- This function adds the frequency of pulse-train input to the speed loop.
- The command is output to the speed loop before position deviation pulses are accumulated, thus reducing the deviation counter value and saving positioning time.
- Feed-forward adjustment will not be effective if the position loop gain and speed loop gain are too high.

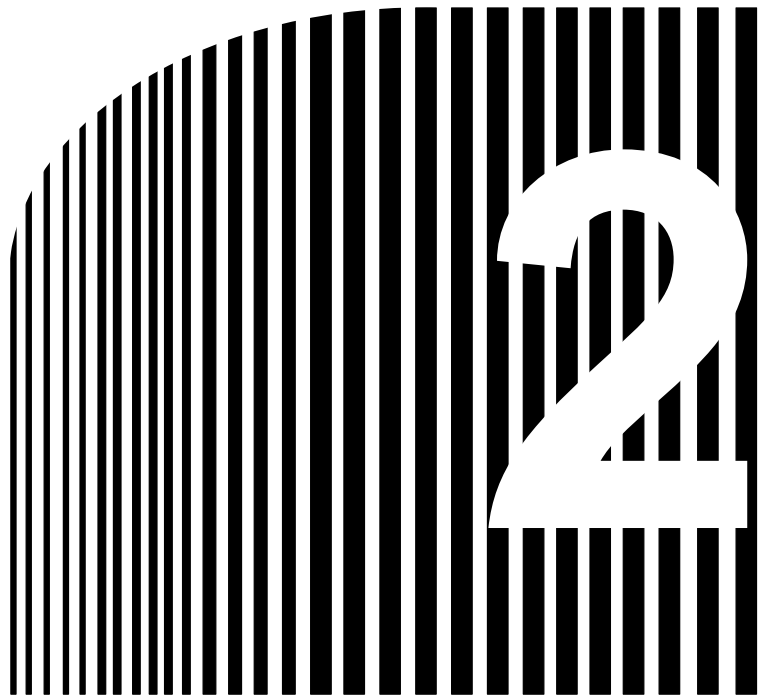

Chapter 2

• Connection to Position Control Unit •

- 2-1 Wiring Check
- 2-2 System Startup Errors
- 2-3 Countermeasures Against Position Deviation

2-1 Wiring Check

Care must be taken for Position Control Unit and Servo Driver connection, which needs a comparatively large number of wires. Be sure that all lines connecting the Position Control Unit and Servo Driver are wired correctly. It will be difficult to find wiring mistakes after completing the Servo System construction.

2-1-1 Wiring Check with I/O Monitor

- U, H, and M Series incorporate an I/O monitor function.
- Wiring mistakes can be easily found by using this function.
- The contents of I/O monitor vary with the Series. Refer to the respective operation manual.

I/O Monitor Example

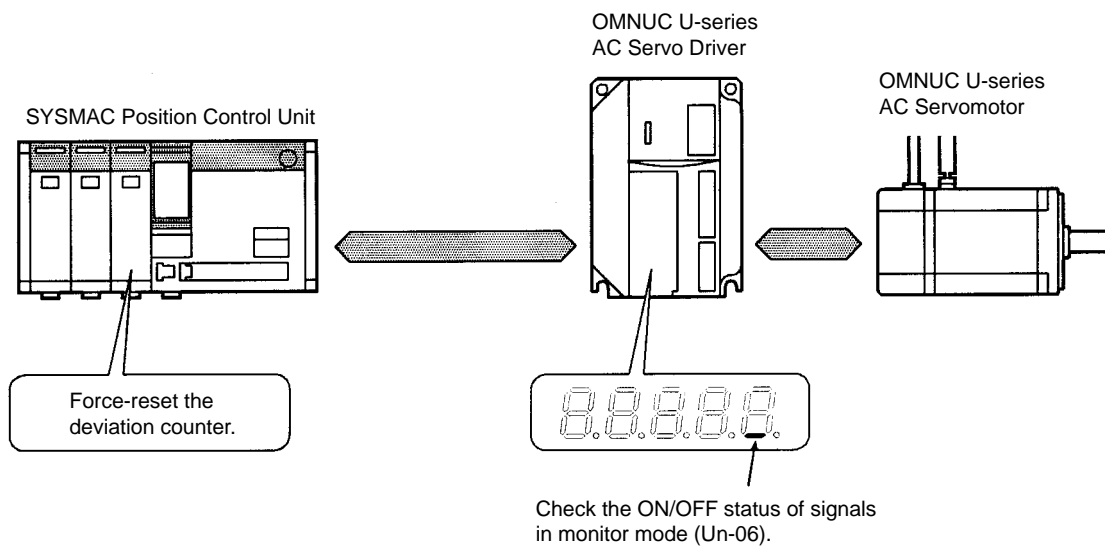

2-1-2 Wiring Check without I/O Monitor

- If no I/O monitor is available, use a multimeter and check the voltage as shown in the following diagram.
- There will be a voltage between the terminals if the output transistor is ON. The reading of the multimeter will be 0 V if the output transistor is OFF.

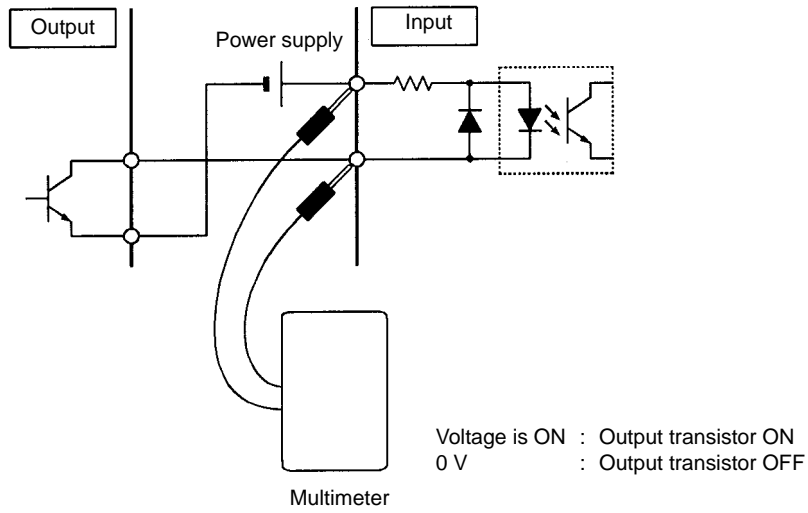

2-2 System Startup Errors

The Position Control Unit may malfunction due to incorrect wiring, setting, or sequence when power is supplied to the Position Control Unit or while the Position Control Unit is operating. Probable causes of system startup errors and countermeasures are described below.

System Does Not Start		
<ul style="list-style-type: none"> The 3G2A5-NC111-EV1 in operation may not detect the startup signal, especially when the Unit is mounted to the following: <ul style="list-style-type: none"> CV-series Backplane Slave Rack 		
Probable cause	Item to check	Countermeasure
The 3G2A5-NC111-EV1 could not detect the startup signal because the startup signal is ON for too short a time.	<ul style="list-style-type: none"> The startup signal is ON for a single cycle time. 	<ul style="list-style-type: none"> Extend the period in which the startup signal is ON so that the 3G2A5-NC111-EV1 can detect the startup signal.

Note 1. The program cycle time of the CV-series PC is shorter than that of the C-series PC. The 3G2A5-NC111-EV1, therefore, may not detect the startup signal correctly if the startup signal is ON for too short a time.

Note 2. The remote communications cycle time is different in timing from the program cycle time. The startup signal, therefore, may not be detected in remote communications if the startup signal is ON for too short a time.

Communications Errors Result		
<ul style="list-style-type: none"> The 3G2A5-NC111-EV1 Unit in operation may cause positioning data communications errors or may have difficulty in reading data correctly, especially when the Unit is mounted to the following: <ul style="list-style-type: none"> CV-series Backplane Slave Rack 		
Probable cause	Item to check	Countermeasure
The communications cycle time clock data is not being transmitted to the 3G2A5-NC111-EV1 correctly.	<ul style="list-style-type: none"> The communications cycle time clock timing is shorter than the remote communications cycle time. The CV's cycle time clock does not suit the 3G2A5-NC111-EV1. 	<ul style="list-style-type: none"> Extend the cycle time clock's ON timing so that the 3G2A5-NC111-EV1 can detect the communications cycle time clock data. Create a clock by using the return signal from the Slave.

Line Disconnection, Reverse Wiring, or Out-of-control Errors Occur		
<ul style="list-style-type: none"> • The Position Control Unit with analog output will be out of control if the polarity of the speed command does not coincide with that of the encoder signal. • If the Position Control Unit cannot recognize the encoder signal correctly, a motor runaway will result or the motor will rotate slowly. 		
Probable cause	Item to check	Countermeasure
Encoder A and B phase lines are connected opposite to each other.	<ul style="list-style-type: none"> • Opposite wiring is detected. • A motor runaway results during servo-lock. 	<ul style="list-style-type: none"> • Connect the lines correctly.
Encoder phase lines are disconnected or the encoder I/O terminal is damaged.	<ul style="list-style-type: none"> • Line disconnection is detected. • The motor rotates slowly during servo-lock. • A motor runaway results during positioning. • The encoder signal does not turn ON or OFF. (The encoder signal output terminal is damaged.) • The deviation counter does not work even though the encoder signal continues turning ON and OFF. (The encoder signal input terminal is damaged.) 	<ul style="list-style-type: none"> • Correct the cable wiring. • Replace the cable. • Replace the Servo Driver. • Replace the Position Control Unit.
The speed command signal is disconnected or the speed command input terminal is damaged.	<ul style="list-style-type: none"> • Line disconnection is detected. • The motor in positioning operation rotates slowly without positioning. • The speed command voltage on the Position Control Unit output terminal does not change. (The speed command output terminal is damaged.) • The motor does not rotate with changes in the speed command on the Servo Driver input terminal. (The speed command input terminal is damaged.) 	<ul style="list-style-type: none"> • Correct the cable wiring. • Replace the cable. • Replace the Position Control Unit. • Replace the Servo Driver.

Line Disconnection, Reverse Wiring, or Out-of-control Errors Occur		
Probable cause	Item to check	Countermeasure
Error occurs in the line disconnection detecting function.	<ul style="list-style-type: none"> The gain is too low. * If the gain is too low, fine positioning will require a long time, which will be determined as line disconnection. 	<ul style="list-style-type: none"> Adjust the gain. (Increase the gain.)
	<ul style="list-style-type: none"> The zero adjustment of the speed command is not correct. * If the zero adjustment is incorrect, the positioning completion signal will not be output, which will be determined as line disconnection. * If the zero adjustment is in the direction opposite to the fine-speed command, the motor will rotate in the opposite direction, which will be determined as reverse wiring. 	<ul style="list-style-type: none"> Make the zero adjustment of the speed command correctly.
	<ul style="list-style-type: none"> External force is affecting the motor torque on the vertical shaft. * If external force is imposed on the motor in the direction opposite to fine positioning, the motor will rotate in the opposite direction, which will be determined as reverse wiring. 	<ul style="list-style-type: none"> Disable the line disconnection detecting function.

Note 1. The absence of the speed command signal, the reverse line connection of A and B phases, the absence of A and B phases, or noise may be a cause of the abnormal motor operation. If the motor is in abnormal operation, the cause may be determined by determining the operating status of the motor at the time of servo-lock and positioning.

Item	Speed command signal disconnection	A and B phase reverse line connection	A and B phase line disconnection	Noise
Servo-lock	Slow rotation	Runaway	Slow rotation	Slow rotation
Positioning	Slow rotation	Runaway	Runaway	Positioning deviation

- “Runaway” indicates a situation in which the motor is out of control and the motor runs in acceleration exceeding its maximum rotation speed.
- “Slow rotation” indicates a situation in which the motor runs at low rotation speed due to Position Control Unit output or Servo Driver input offset.

Refer to *Chapter 4 Countermeasures Against Noise* if noise is the cause of the problem.

Note 2. Some of the OMRON Position Control Units incorporate a line disconnection detecting function. Such a model will be in fine positioning operation automatically when it is turned on, at which time, if the motor turns in the opposite direction due to reversed wiring or the positioning operation does not complete within the specified period, an error will result.

Note 3. If a signal line or connector disconnection is detected, the cable may be, however, in a fully conducting state. When there is no encoder signal or speed command signal, check the resistance of the cable by pulling or bending the cable.

Command Timing Errors Result		
<ul style="list-style-type: none"> Command timing errors are detected when the C500-NC221-E or C500-NC222-E is in use. The error will be detected if a command that is not executable (e.g., the positioning command) is input while the C500-NC221-E or C500-NC222-E is in positioning operation. 		
Probable cause	Item to check	Countermeasure
A command input is not executable.	<ul style="list-style-type: none"> The ladder program in use does not check the status of the C500-NC221-E or C500-NC222-E. <p>Example: The C500-NC221-E or C500-NC222-E starts up on receipt of the Equal Flag of data transfer completion.</p>	<ul style="list-style-type: none"> Change the program so that a command will be given after checking the status of the C500-NC221-E or C500-NC222-E.

Origin Proximity Non-detection Errors Result		
<ul style="list-style-type: none"> The C200H NC Unit will detect an origin proximity non-detection error if the origin proximity signal is not input while the NC Unit is set for detecting the origin proximity signal. The origin proximity signal can be ignored if origin search mode 0 is selected for the NC Unit. The origin proximity signal cannot be ignored, however, if origin search mode 1, 2, or 3 is selected for the NC Unit. 		
Probable cause	Item to check	Countermeasure
No origin proximity signal is input.	<ul style="list-style-type: none"> No origin proximity signal is connected to the origin proximity input terminal. 	<ul style="list-style-type: none"> Input the origin proximity signal.
	<ul style="list-style-type: none"> The origin search mode setting is incorrect. 	<ul style="list-style-type: none"> Select mode 0 and set the NC Unit to No Origin Proximity.

Origin Non-detection Errors Result		
<ul style="list-style-type: none"> The C200H NC Unit has an origin non-detection error if the operation limit signal is detected while the origin signal is ON and the NC Unit is in origin search operation. 		
Probable cause	Item to check	Countermeasure
No origin signal is input.	<ul style="list-style-type: none"> No origin signal is connected to the origin signal input terminal. 	<ul style="list-style-type: none"> Input the origin signal.
	<ul style="list-style-type: none"> No origin signal is input due to wiring mistakes or line disconnection. 	<ul style="list-style-type: none"> Connect the lines correctly.

The Next Positioning Operation is Not Performed. The Rising Edge of the Positioning Completion Signal is Not Detected.		
<ul style="list-style-type: none"> • The next positioning step will be usually taken after the confirmation of the present positioning completion signal. • Therefore, if the completion of positioning is not confirmed, the Position Control Unit cannot take the next stop and the operation is interrupted. 		
Probable cause	Item to check	Countermeasure
The positioning time is short compared with the cycle time.	<ul style="list-style-type: none"> • The positioning operation has completed normally and the positioning completion signal has been output. The PC cannot, however, check that the completion signal has been turned OFF. 	<ul style="list-style-type: none"> • Use the positioning completion dwell timer and delay the output timing of the positioning completion signal. • Use the M code and confirm that the completion signal has been turned OFF by checking status changes in the M code.
The positioning completion signal is not output or it takes too long to output the positioning completion signal.	<ul style="list-style-type: none"> • The positioning operation is performed normally but the positioning completion signal is not output. • Incorrect gain adjustment has been made and the gains are too low. • The zero adjustment of the speed command is incorrect and the value of the deviation counter is large when the Position Control Unit stops. • The set value of positioning completion width is too small. 	<ul style="list-style-type: none"> • Adjust the gains. • Adjust the zero adjustment of the speed command. • Increase the set value of positioning completion width.

Deviation Counter Overflow Results		
<ul style="list-style-type: none"> • The deviation counter is in control of the difference between the command position and actual motor position. • If the difference between the command position and motor position is too large, the deviation counter will overflow and a deviation counter error or deviation counter overflow will result. • The error results if the motor cannot carry out the command. 		
Probable cause	Item to check	Countermeasure
The gains are too low.	<ul style="list-style-type: none"> • The motor response is slow. (Use speed monitor.) 	<ul style="list-style-type: none"> • Adjust the gains. (Increase the gains.)
The gains are too high.	<ul style="list-style-type: none"> • Overshooting is resulting. (Use speed monitor.) 	<ul style="list-style-type: none"> • Adjust the gains. (Decrease the gains.)
The speed command value is too large.	<ul style="list-style-type: none"> • The speed command voltage is set to a value exceeding 10 V. 	<ul style="list-style-type: none"> • Reset the value to 10 V or less. • Use parameters, such as a speed command scale, and decrease the command voltage that is used for obtaining the rated rotation speed.
The load is too heavy. Acceleration/Deceleration time is too short.	<ul style="list-style-type: none"> • The Servo Driver is generating its maximum torque at deceleration or acceleration time. (Use current monitor.) 	<ul style="list-style-type: none"> • Decrease the load. • Increase acceleration/deceleration time.

2-3 Countermeasures Against Position Deviation

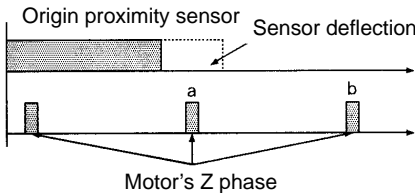
Origin Search Position Deviates		
<ul style="list-style-type: none"> • There are some reasons for position deviation after origin search completion. • Position deviation will occur whenever the origin is searched if any coupling or joint of the machine system has a problem. • If the position between the origin proximity sensor and that of the encoder's Z phase are too close to each other, there will be a deviation of one rotation of the motor (1/2 rotation if the M Series is used). 		
Probable cause	Item to check	Countermeasure
A joint of the machine system deviates.	<ul style="list-style-type: none"> • A joint of the machine system (especially a section where parts are connected with friction) deviates. <p>*Such a section can be easily found by marking it.</p>	<ul style="list-style-type: none"> • Increase the joint strength.
The position of the origin proximity sensor and that of the encoder's Z phase are too close to each other.	<ul style="list-style-type: none"> • There is a deviation of one rotation of the motor (or 1/2 rotation if the M Series is used) on completion of origin search. <p>*Cause of Origin Deviation</p>  <p>Due to the deflection of the origin proximity sensor, it will be unknown whether the machine origin will be a or b.</p> <p>If the sensor is a proximity sensor, the origin varies with the sensing distance and ambient temperature.</p>	<ul style="list-style-type: none"> • Move the position of the origin proximity sensor for a distance of 1/2 rotation of the motor (or 1/4 rotation if the M Series is used). • Loosen the coupling that connects the motor shaft and the machine system, turn the motor shaft for 1/2 rotation of the motor (or 1/4 rotation if the M Series is used), and tighten the coupling again.

The Position Control Unit Stops Abruptly. Position Deviation with Insufficient Moving Distance Occurs.		
<ul style="list-style-type: none"> • The Position Control Unit in positioning operation stops abruptly and then starts operating again. • The Position Control Unit abruptly decelerates to a stop with heavy shock being imposed on the machine system. 		
Probable cause	Item to check	Countermeasure
The incorrect deviation counter reset or origin reset signal is input.	<ul style="list-style-type: none"> • The incorrect deviation counter reset or origin reset signal is input in the program. 	<ul style="list-style-type: none"> • Correct the program.
	<ul style="list-style-type: none"> • Noise is affecting the deviation counter reset or origin reset command signal line. 	<ul style="list-style-type: none"> • Take countermeasures against noise. Refer to <i>Chapter 4 Countermeasures Against Noise</i>.

Moving Distance is Insufficient/Excessive. Rotation Speed is Too Slow/Fast.		
<ul style="list-style-type: none"> Actual moving distance and rotation speed are different from specified moving distance and rotation speed. 		
Probable cause	Item to check	Countermeasure
Pulse rate setting mistake.	<ul style="list-style-type: none"> The pulse rate set value is different from the actual pulse rate. 	<ul style="list-style-type: none"> Set the pulse rate correctly.

Note 1. The pulse rate is the movement distance of the machine system per motor pulse.

Note 2. Be sure to check the following set values when a digital Servo Driver is applied.

Actual movement distance or rotation speed will not coincide with the specified movement distance or rotation speed if the set values are incorrect.

U Series: Electronic gear ratios (G1 and G2), encoder dividing ratio setting, and command pulse mode

H Series: Electronic gear multiplication ratios (G1 and G2) and encoder output specification

M Series: Resolver segment number (G1 and G2)

Position Deviation Occurs Gradually if the Unit is Operated Repeatedly. The Position Determined Changes Slightly.		
<ul style="list-style-type: none"> Position deviation is not large but still varies with the operating speed of the Position Control Unit. 		
Probable cause	Item to check	Countermeasure
A joint of the machine system deviates.	<ul style="list-style-type: none"> A joint of the machine system (especially a section where parts are connected with friction) deviates. *Such a section can be easily found by marking it. 	<ul style="list-style-type: none"> Increase the joint strength.
The pulse frequency is too high and the pulse cannot be read correctly.	<ul style="list-style-type: none"> The command pulse frequency output from the Position Control Unit exceeds the response frequency of the Servo Driver with pulse-train input. 	<ul style="list-style-type: none"> Decrease the command speed. Decrease the pulse frequency and adjust with the electronic gear (for U, H, and M Series)
	<ul style="list-style-type: none"> The encoder signal frequency that is output from the Servo Driver with analog input exceeds the response frequency of the Position Control Unit (see note). 	<ul style="list-style-type: none"> Decrease the command speed. Decrease the number of output pulses (for U, H, and M Series)
Position deviation due to noise.	<ul style="list-style-type: none"> The command pulse output from the Position Control Unit is affected by noise. The encoder signal output from the Servo Driver is affected by noise. 	<ul style="list-style-type: none"> Take countermeasures against noise. Refer to <i>Chapter 4 Countermeasures Against Noise</i>.

Note The output phase error of the Servo Driver must be taken into consideration when calculating the pulse frequency. For details on the output phase error, refer to the Operation Manual of the Servo Driver in use.

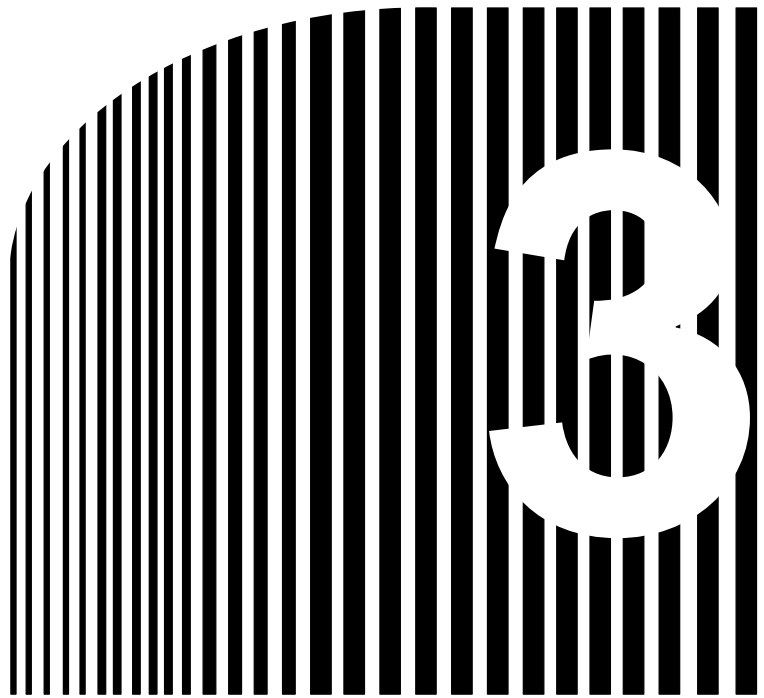

Chapter 3

• Servo Driver Errors •

3-1 Alarms and Countermeasures

3-1 Alarms and Countermeasures

This chapter describes probable causes of alarms that may go off while the Servo Driver is in operation and countermeasures to be taken. In some cases, the built-in circuitry of the Servo Driver may be damaged if alarms are reset without taking proper countermeasures. If an alarm occurs, turn off the Servo Driver immediately after checking the meaning of the alarm, take full countermeasures, and then turn on the Servo Driver. Errors that may damage the Servo Driver and those that may result relatively frequently are explained in the following.

Refer to the Operation Manual of the Servo Driver for details on other errors.

Main Circuit Overcurrent		
<p>If any of the following errors result, turn off the Servo Driver immediately. Do not turn on the Servo Driver until the causes are checked and countermeasures are taken. Do not replace the Servo Driver or motor without finding out the cause of the error. The built-in circuitry of the Servo Driver may be completely damaged if the Servo Driver is turned on without taking proper countermeasures. Do not replace any Unit without checking the causes and taking countermeasures, otherwise the Unit may be damaged.</p>		
<ul style="list-style-type: none"> • These errors will result if there is an excessive current flow to the main circuitry of the Servo Driver. • Excessive current may flow if a ground fault or short-circuit results on the lines between the capacitor of the main circuitry and motor. 		
<p>Alarm Indication</p> <p>U Series: A. 10 H Series: E4 M Series: A. L-1 R Series: OC</p>		
Probable cause	Item to check	Countermeasure
The power cable has been short-circuited.	<ul style="list-style-type: none"> • Phase lines are short-circuited. * Check the resistance of the cable alone. 	<ul style="list-style-type: none"> • Replace the cable. • Repair the cable.
The power cable had a ground fault.	<ul style="list-style-type: none"> • A power line and the FG (frame ground) are short-circuited. * Check the resistance of the cable alone. 	<ul style="list-style-type: none"> • Replace the cable. • Repair the cable.
The motor has burned out.	<ul style="list-style-type: none"> • The motor gives off a burning smell. • The phase-to-phase resistance of the motor is different from the coil resistance. *1. Check the specifications of the motor. *2. If the coil resistance is unknown, be sure that all phase-to-phase resistance readings are the same. If not, the motor must have burned out. 	<ul style="list-style-type: none"> • Replace the motor.
The transistor of the main circuitry has burned out.	<ul style="list-style-type: none"> • The resistance between each combination of these terminals is 100 Ω maximum. P (PA) - A (U) N (NA) - A (U) P (PA) - B (V) N (NA) - B (V) P (PA) - C (W) N (NA) - C (W) * Check the resistance twice by interchanging the probes of the multimeter. If each resistance reading is 100 Ω max., the transistor is damaged. 	<ul style="list-style-type: none"> • Replace the Servo Driver.

Note It is unlikely that only the Servo Driver is damaged. If the Servo Driver is damaged, carefully check whether other parts or devices are damaged.

Main Circuit Overvoltage		
<ul style="list-style-type: none"> An alarm goes off if an excessive voltage is imposed on the main circuitry of the Servo Driver. The excessive voltage may be imposed from the power supply side or motor side due to power feedback to the capacitor. 		
Alarm Indication U Series: A. 40 H Series: E3 M Series: A. L-2 R Series: OV		
Probable cause	Item to check	Countermeasure
Abnormal power supply voltage.	<ul style="list-style-type: none"> The power supply voltage is not within the allowable range. *Check the rating. 	<ul style="list-style-type: none"> Apply voltage that is within the allowable range.
	<ul style="list-style-type: none"> A surge from high-capacity equipment that is close to the Servo Driver is imposed on the power lines. 	<ul style="list-style-type: none"> Eliminate the surge with a surge absorber. Provide power to the high-capacity equipment from an independent power supply.
The regenerative voltage is too high.	<ul style="list-style-type: none"> An error results at the time of deceleration or while lowering the vertical shaft. The voltage between P (PA) and N (NA) of the main circuitry is 380 VDC min. when the motor is running. 	<ul style="list-style-type: none"> Connect a Regeneration Unit. Increase the capacity of the regeneration capacitor. (Applicable to the U and H Series.)
A disconnection or a wiring mistake of the External Regeneration Resistor. (Applicable to M-, R-, and H-series Power Supply Units.)	<ul style="list-style-type: none"> There is a wiring mistake of the External Regeneration Resistor. 	<ul style="list-style-type: none"> Wire the External Regeneration Resistor correctly.
	<ul style="list-style-type: none"> The External Regeneration Resistor has burned out. The resistance of the External Regeneration Resistor is wrong. 	<ul style="list-style-type: none"> Replace the External Regeneration Resistor.
The regeneration transistor has burned out.	<ul style="list-style-type: none"> The resistance between each combination of these terminals is ∞. RG-N (H-series Power Supply Unit) JP1-NA (M Series) RG-N (R-series Power Supply Unit) RG-N (R-series Regeneration Unit) * Check the resistance twice by interchanging the probes of the multimeter. If each resistance reading is 100 Ω max., the transistor is damaged. 	<ul style="list-style-type: none"> Replace the Unit.

Note 1. If the regeneration transistor is found damaged, check the resistance of the External Regeneration Resistor. It is possible that the transistor was damaged because the resistance of the External Regeneration Resistor was incorrect.

Note 2. The regeneration is calculated from the terminal voltage of the External Regeneration Resistor. The External Regeneration Resistor must withstand regeneration that is three to five times larger than the regeneration calculated from the following.

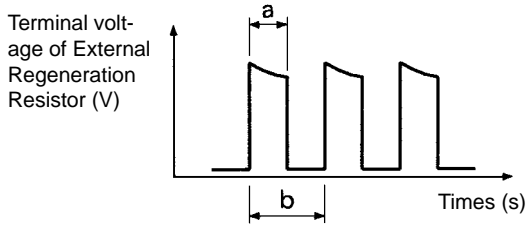

$$\text{Regeneration (W)} = \frac{a}{b} \times \frac{(380)^2}{R} \times \frac{\text{Regeneration time}}{\text{Total operation time}}$$

R: Resistance of External Regeneration Resistor (Ω)

Main Circuit Voltage Drop

- An alarm will go off if the voltage imposed on the main circuitry of the Servo Driver is less than the allowable range.
- The voltage imposed on the main circuitry will be less than the allowable range if the power supply voltage is too low or insufficient power is supplied to the main circuitry due to phase interruption.
- This alarm is also called the momentary power failure alarm or phase interruption alarm.

Alarm Indication

- U Series: A. F3
- H Series: E23
- M Series: A. L-3
- R Series: OC

Probable cause	Item to check	Countermeasure
Abnormal power supply voltage.	<ul style="list-style-type: none"> • The power lines are disconnected. 	<ul style="list-style-type: none"> • Connect the power lines correctly.
	<ul style="list-style-type: none"> • The power supply voltage is not within the allowable range. * Check the rating. 	<ul style="list-style-type: none"> • Apply voltage that is within the allowable range.
Phase interruption of 3-phase power supply	<ul style="list-style-type: none"> • The voltage between either one of the combinations of these terminals is 200 VAC. R-S, R-T * Applicable to the Servo Driver with 3-phase, 200-V input. 	<ul style="list-style-type: none"> • Connect the power lines correctly.
The fuse was blown out or the rectifier was damaged.	<ul style="list-style-type: none"> • The fuse was blown out. * Check the fuse visually or with a multimeter. • The resistance between each combination of these terminals is ∞. P (PA) - R, P (PA) - S, P (PA) - T N (NA) - R, N (NA) - S, N (NA) - T * Check the resistance twice by interchanging the probes of the multimeter. If each resistance reading is ∞, the transistor is damaged. 	<ul style="list-style-type: none"> • Replace the Servo Driver after making sure that there is no overcurrent flow to the main circuit.

Main Circuit Voltage Drop		
Probable cause	Item to check	Countermeasure
The fuse of the power supply for the main circuit contactor was blown out. (Applicable to the M Series only.)	• There is no 200 VAC output between terminals B and O.	• Replace the Servo Driver.
	• A power supply is connected to terminals B and O.	• Correct the wiring and replace the Servo Driver.
	• Terminals B and O have a ground fault and outputs from the terminals are grounded.	• Fix the ground fault and replace the Servo Driver.
The fuse of the inrush current prevention circuit was blown out. (Applicable to the M Series only.)	• There is no 24 VDC output on the PON terminals or BI terminals. * Remove the short bar when checking the voltage.	• Replace the Servo Driver.
	• A power supply is connected to the PON terminals or BI terminals.	• Correct the wiring and replace the Servo Driver.
	• The PON terminals or BI terminals have a ground fault and outputs from the terminals are grounded.	• Fix the ground fault and replace the Servo Driver.

Overload		
<p>If an overload error results, turn off the power to the main circuitry and do not turn on the power for at least 10 minutes. Do not turn on the power until the causes are checked and countermeasures are taken.</p> <p>If the power is turned on without taking countermeasures, the motor coil may burn out.</p>		
<ul style="list-style-type: none"> • An alarm will go off if the output current of the Servo Driver is more than 120% of the rated current continuously. • The output current continuously exceeds the rated current in the following cases: <ul style="list-style-type: none"> The motor is affected by gravity torque. The machine system has excessive friction. The machine system does not work and the motor shaft is locked due to secular changes, deformation, or foreign materials in the driving components. The load inertia is excessive. 		
<p>Alarm Indication</p> <p>U Series: A. 71, A. 72 H Series: E22 M Series: A. L-17, A. L-18 R Series: OL</p>		
Probable cause	Item to check	Countermeasure
Motor overload.	• The output current is more than 120% of the rated current continuously.	• Decrease the load or load inertia.
	• The effective value of the output current is more than 120% of the rated current. (Use the current monitor or indicator.)	• Increase the acceleration/deceleration time to decrease the acceleration/deceleration torque.
	• Motor parameter settings are wrong. (Applicable to M Series.)	• Increase the motor capacity.
		• Make motor parameter settings correctly.

Overload		
Probable cause	Item to check	Countermeasure
The motor shaft is locked.	<ul style="list-style-type: none"> • The machine system does not operate smoothly. • The machine system came to a halt after colliding with some object. • The output current is at maximum. (Use the current monitor or indicator.) 	<ul style="list-style-type: none"> • Perform machine maintenance. • Repair the machine system.
A disconnection or a mistake in the wiring of power lines.	<ul style="list-style-type: none"> • There is a disconnection or a mistake in the wiring of power lines. 	<ul style="list-style-type: none"> • Connect the power lines correctly.
The motor shaft is damaged.	<ul style="list-style-type: none"> • The motor shaft does not rotate smoothly without a load. * Make sure that the lead wires of the motor do not touch together. • The motor shaft bearing is rusty. 	<ul style="list-style-type: none"> • Replace the motor.
Abnormal motor current phase angle.	<ul style="list-style-type: none"> • The output current with servolock is more than 110% of the rated current without influence of external force. • No overload results if the Servo Driver or motor is replaced. 	<ul style="list-style-type: none"> • Replace the Servo Driver. • Replace the motor.

Note The following may cause motor shaft damage.

- An abnormal thrust or radial load is imposed on the shaft.
- There is corrosive gas around the motor.

In the above cases, the same problem will occur even after the motor is replaced. Check the causes of motor damage, take proper countermeasures against it, and then replace the motor.

Overspeeding		
<ul style="list-style-type: none"> An alarm will go off if the rotation speed of the motor is abnormal, as in the following cases: The rotation speed has exceeded the maximum allowable rotation speed. The rotation signal is not returned from the motor in response to a command from the Servo Driver. A command is input for the motor to run at a speed exceeding the maximum allowable rotation speed. 		
Alarm Indication U Series: A. 51, A. 52, A. C1, A. C2 H Series: E22 M Series: A. L-16, A. L-19, A. L-20 R Series: O. RUN		
Probable cause	Item to check	Countermeasure
Abnormal speed command input	<ul style="list-style-type: none"> The voltage of the speed command input (analog input) is higher than the voltage corresponding to the maximum allowable rotation speed. The frequency of the command pulse input (pulse-train input) is higher than the frequency corresponding to the maximum allowable rotation speed. 	<ul style="list-style-type: none"> Decrease the command speed.
Parameter setting mistake.	<ul style="list-style-type: none"> The speed command scale exceeds the maximum allowable rotation speed. (Applicable to analog input.) 	<ul style="list-style-type: none"> Fix the speed command scale setting.
	<ul style="list-style-type: none"> The encoder dividing ratio setting for pulse output is too small. (Applicable to analog input.) 	<ul style="list-style-type: none"> Fix the number of output pulses.
	<ul style="list-style-type: none"> The electronic gear ratio is too large. (Applicable to pulse-train input.) 	<ul style="list-style-type: none"> Fix the electronic gear ratio.
Overspeeding due to overshooting.	<ul style="list-style-type: none"> Overshooting exceeding the maximum allowable rotation speed results at the time of acceleration. (Use the speed monitor.) 	<ul style="list-style-type: none"> Adjust the gain and suppress the overshooting as much as possible.
Abnormal encoder cable Abnormal resolver cable	<ul style="list-style-type: none"> The cable is disconnected. The cable is short-circuited. * Check the resistance of the cable alone. 	<ul style="list-style-type: none"> Replace the encoder cable. Replace the resolver cable.
Power cable disconnection.	<ul style="list-style-type: none"> The power cable is disconnected. * Check the resistance of the cable alone. 	<ul style="list-style-type: none"> Replace the power cable.
Abnormal motor.	<ul style="list-style-type: none"> Motor phases are open. *Check the resistance of the motor alone. 	<ul style="list-style-type: none"> Replace the motor.
Signal errors caused by noise.	<ul style="list-style-type: none"> None of the above items applies. The frequency and conditions of error are indefinite. 	<ul style="list-style-type: none"> Take countermeasures against noise. Refer to <i>Chapter 4 Countermeasures Against Noise</i>.

Note 1. In many cases, signal cable errors will be detected together with encoder or resolver disconnection errors.

Note 2. If the cable contact is improper, the resistance of the cable will vary slightly. To check a slight difference in resistance in such a case, use a multimeter that has a mΩ range.

Encoder (Resolver) Disconnection		
<ul style="list-style-type: none"> An alarm will go off if there is no encoder or resolver voltage output. 		
Alarm Indication U Series: A. C3, A. C4 H Series: E1 M Series: A. L-6 R Series: RE. E		
Probable cause	Item to check	Countermeasure
Abnormal encoder signal lines. Abnormal resolver signal lines.	<ul style="list-style-type: none"> The signal lines are disconnected. The signal lines are short-circuited. * Check the resistance of the cable alone. 	<ul style="list-style-type: none"> Replace the encoder cable. Replace the resolver cable.
Motor overheating.	<ul style="list-style-type: none"> The surface temperature of the encoder exceeds 70°C. (Applicable to H and R Series only.) 	<ul style="list-style-type: none"> Decrease the motor ambient temperature. Take the same countermeasures as those against motor overload.
Encoder or resolver malfunctions.	<ul style="list-style-type: none"> Do not turn any output signal of the encoder on and off if the voltage of the output signal between the output terminal and the power supply ground of the encoder is 2.5 V min. The resistance between each combination of these terminals of the resolver is far from the rated resistance. SIN energized terminals: 100 Ω COS energized terminals: 110 Ω Resolver output terminals: 5,000 Ω 	<ul style="list-style-type: none"> Replace the motor.
Signal errors caused by noise.	<ul style="list-style-type: none"> None of the above items applies. The frequency and conditions of error are indefinite. 	Take countermeasures against noise. Refer to <i>Chapter 4 Countermeasures Against Noise</i> .

Note 1. In many cases, signal cable errors will be detected together with encoder or resolver disconnection errors.

Note 2. If the cable contact is improper, the resistance of the cable will vary slightly. To check a slight difference in resistance in such a case, use a multimeter that has a mΩ range.

Deviation Counter Overflow		
<ul style="list-style-type: none"> • An alarm will result if the deviation counter overflows. • This error results with the Servo Driver with pulse-train input. • The deviation counter will overflow if the motor cannot carry out the command. 		
Alarm Indication U Series: A. 31 H Series: E25 M Series: A. L-21 R Series: O. RUN		
Probable cause	Item to check	Countermeasure
The gains are too low.	<ul style="list-style-type: none"> • The motor response is slow. (Use speed monitor.) 	<ul style="list-style-type: none"> • Adjust the gains. (Increase the gains.) • Make feed-forward adjustments to reduce the number of pulses accumulated by the deviation counter.
The gains are too high.	<ul style="list-style-type: none"> • Overshooting is resulting. (Use speed monitor.) 	<ul style="list-style-type: none"> • Adjust the gains. (Decrease the gains.)
Parameter setting mistake.	<ul style="list-style-type: none"> • The electronic gear ratio is too large. 	<ul style="list-style-type: none"> • Fix the electronic gear ratio.
The output torque is insufficient due to current limitation, which increase acceleration/deceleration time.	<ul style="list-style-type: none"> • The output current of the Servo Driver is limited with the current limit value. (Use current monitor, signal output, and monitor indicator.) 	<ul style="list-style-type: none"> • Increase the current limit value. • Turn off the current limit input signal.
The frequency of the command pulse input is too high.	<ul style="list-style-type: none"> • The frequency of the command pulse input is higher than the frequency corresponding to the maximum allowable rotation speed. 	<ul style="list-style-type: none"> • Decrease the command speed.
The motor shaft is locked.	<ul style="list-style-type: none"> • The machine system does not operate smoothly. • The machine system came to a halt after colliding with some object. • The output current is at maximum. (Use the current monitor or indicator.) 	<ul style="list-style-type: none"> • Perform machine maintenance. • Repair the machine system.
The load is too heavy. Acceleration/Deceleration time is too short.	<ul style="list-style-type: none"> • The Servo Driver is generating its maximum torque at deceleration or acceleration time. (Use current monitor.) 	<ul style="list-style-type: none"> • Decrease the load. • Increase acceleration/deceleration time.
A disconnection or a mistake in wiring of the power lines.	<ul style="list-style-type: none"> • There is a disconnection or a mistake in the wiring of the power lines. 	<ul style="list-style-type: none"> • Connect the power lines correctly.
Abnormal encoder signal lines. Abnormal resolver signal lines.	<ul style="list-style-type: none"> • The signal lines are disconnected. • The signal lines are short-circuited. * Check the resistance of the cable alone. 	<ul style="list-style-type: none"> • Replace the encoder cable.
Abnormal motor.	<ul style="list-style-type: none"> • The phase-to-phase resistance of the motor is different from the coil resistance. 	<ul style="list-style-type: none"> • Replace the motor.

Servo Driver Overheating		
An alarm will go off if the internal temperature (i.e., heat sink temperature) of the Servo Driver exceeds 90°C.		
Alarm Indication U Series: A. 10 H Series: E21 M Series: A. L-8, A. L-9 R Series: OH		
Probable cause	Item to check	Countermeasure
The ambient temperature is high.	<ul style="list-style-type: none"> The ambient temperature for the Servo Driver is higher than 55°C. 	<ul style="list-style-type: none"> Decrease the ambient temperature with a cooling fan or cooling unit. Locate the Servo Driver in a place where the ambient temperature is low enough.
The regeneration is excessive. (Applicable to M and R Series only.)	<ul style="list-style-type: none"> The regeneration is beyond the processing capability of a single Servo Driver. * Check the regeneration from the voltage waveform obtained from the terminals of the regeneration resistor. Refer to <i>Main Circuit Overvoltage</i> on page 3-4. 	<ul style="list-style-type: none"> Connect the External Regeneration Resistor.
Insufficient rotation of cooling fan or clogged filter. (Application to M Series only.)	<ul style="list-style-type: none"> The fan is not rotating. * Check the fan visually. 	<ul style="list-style-type: none"> Replace the Servo Driver. Replace the fan.
	<ul style="list-style-type: none"> The filter is clogged with dirt. 	<ul style="list-style-type: none"> Clean the filter.
The load is too heavy.	<ul style="list-style-type: none"> The Servo Driver is in continuous operation with its output current exceeding the rated current. (Use the current monitor or indicator.) 	<ul style="list-style-type: none"> Reduce the load. Increase the acceleration/deceleration time. Increase the motor capacity.

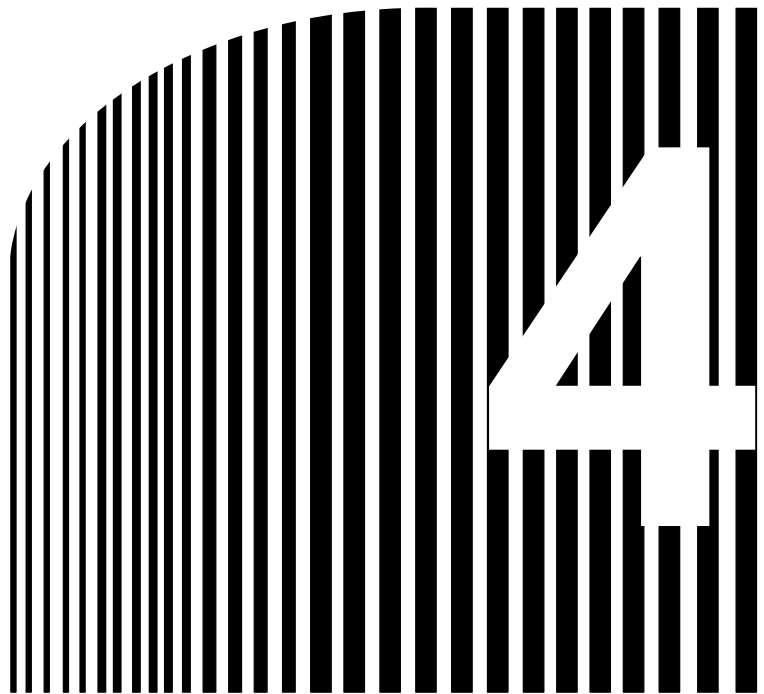

Chapter 4

• Countermeasures Against Noise •

- 4-1 Generation and Types of Noise
- 4-2 Noise Suppression

4-1 Generation and Types of Noise

The elimination of noise influence on the Servo System is indispensable for increasing the reliability of the Servo System. If the protection of the Servo System from noise is insufficient, the Units in the system will be damaged in the worst case. Even if the Units are not damaged, the Servo System will not be able to fulfill its functions, e.g., the rotation of the motor may be unstable or correct positioning may not be possible with the Servo System.

4-1-1 Noise

■ Definition of Noise

Noise is an indefinite, unnecessary signal that may be generated as a natural phenomenon or artificially from machine equipment. Most types of noise are generated artificially and transmitted through unexpected transmission paths to other signal lines.

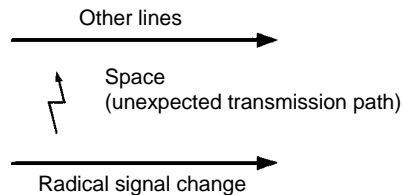



4-1-2 Types of Noise

■ Sources of Noise Generation

A machine or component that handles radical voltage or current changes can be a source of noise generation. Noise generated by such a machine or component will increase in accordance with an increase in the radical voltage or current change level, and higher the voltage or current is, the more intense the noise generation from the machine or component will be.

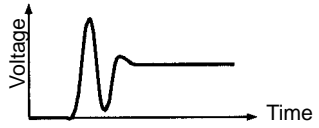
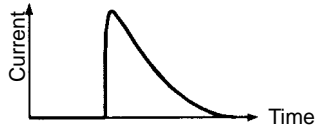
■ Types of Noise and Typical Noise Sources

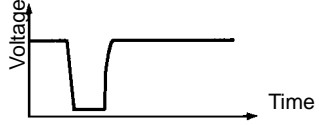
Kind	Generation	Machine or component	Signal waveform
Coil surge	A coil generates a surge when the voltage imposed on the coil is turned on and off.	Relay Solenoid Contactor	
Capacitor charge current	A high-charge current flows when voltage is imposed on a capacitor.	Built-in power supply Power supply Capacitive-discharge machine	
Pulse voltage	Pulse voltage from PWM (see note).	Servo Driver Inverter Switching current	
Arc discharge	Radical voltage changes with discharge.	Welding machine Arc-discharge tube	

Note PWM is an abbreviation for pulse-width modulation, which makes average voltage changes by intermittently turning the voltage on and off with short intervals.

4-1-3 Noise Transmission Paths

Noise is transmitted through the following four paths.

● Capacitive Coupling Path

Noise signals with radical changes are transmitted from one line to another through an electric field generated between the signal lines like an imaginary capacitor. The efficiency of such noise transmission will increase in accordance with an increase in noise-signal change level and a decrease in transmission path distance.

Effects

Noise transmission between signal cables.

Motor leakage current.

Sensor malfunctions.

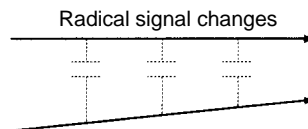

Signals are transmitted through the electric field like an imaginary capacitor.

● **Conductive Path**

Noise signals with radical changes are transmitted from a power line to another line or control equipment through the FG (frame ground) or conductive cable. Noise may be transmitted through the FG or conductive cable after the noise is transmitted to the FG or conductive cable through the other noise transmission paths.

Effects

Control equipment malfunctions.

Noise on power supply lines.

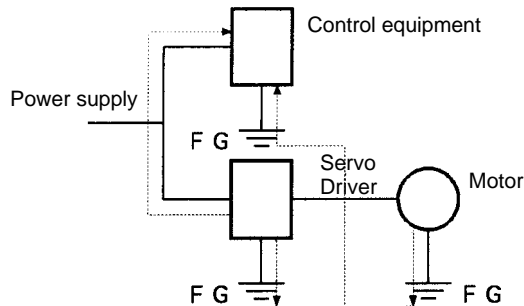

● **Electromagnetic Inductive Path**

Noise with radical changes creates magnetic fields around the noise. Such magnetic fields induce electromotive force from signal lines close to the magnetic fields. Such induction will increase in accordance with an increase in noise-signal change level and a decrease in noise transmission distance between the signal lines and magnetic fields.

Effects

Noise transmission between signal cables.

Noise from motor power lines.

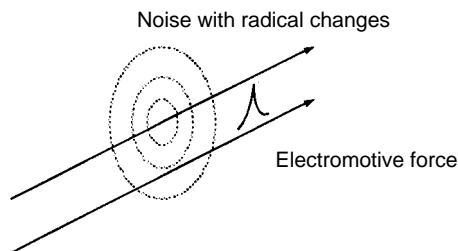

● **Radio Transmission Path**

Noise signals with radical changes are radiated from signals lines working as antennas. The Servo System may leak noise from the cable lines as shown in the illustration below.

Effects

Radio and TV interference.

Radio sensor malfunctions.

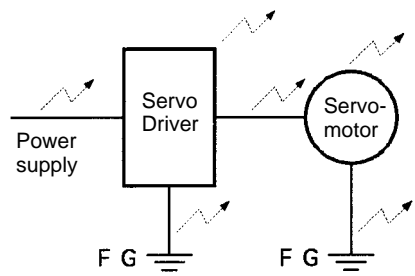

4-2 Noise Suppression

Noise is generated from equipment and transmitted through unexpected transmission paths. Noise suppression means the prevention of the generation of noise from such noise sources and block the transmission of noise through noise transmission paths.

4-2-1 Countermeasures

The following four items are essential for noise suppression.

Searching for Noise Sources

Noise is generated from many types of equipment that make radical changes in voltage and current output. The larger the signal power handled is, the more powerful the noise source will be. Refer to *4-1-2 Types of Noise* and list all probable noise sources close to the Servo System.

Clarifying Noise Transmission Paths

If a noise source, its type, and its characteristics are known, check all probable noise transmission paths in sequence beginning with the most probable path, and find out which paths are used for noise transmission. It may be a good idea to use a shield plate connected to the FG (frame ground) and check the possibility of noise transmission through radio transmission, electromagnetic induction, and capacitive coupling paths.

Cancellation of Countermeasures at Last Stage

Do not cancel countermeasures on any path if they are not effective. There may be more than one noise transmission path. The path on which the countermeasures have been taken may be a secondary noise transmission path.

Highly Possible Noise Transmission Path to Servo System

The Servo System or inverter has a high current leakage to the FG through the capacitive coupling of the motor. Therefore, if the current absorption of the FG is poor, the electric potential of the FG will be unstable. This will easily transmit noise to other equipment through the FG. Be sure to take countermeasures against such current leakage when using Servo Systems or inverters.

4-2-2 Practical Noise Suppression

The following describes practical noise suppression and current leakage suppression for each noise transmission path.

■ Capacitive Coupling Path

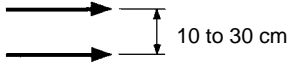
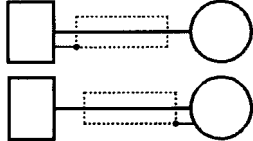
Countermeasure	Purpose	Precautions	Wiring
Separation of signal lines	Reduction of capacitive coupling	Keep signal lines at least 10 cm away from each other. Ideally, the signal lines are kept 30 cm away from each other.	
Shielding with conductive materials (panel or metal conduit)	Reduction of capacitive coupling	Be sure to connect the shield to the FG (frame ground). Ground only one end of the shield. The shield must be free of any current flow.	

■ Conductive Path

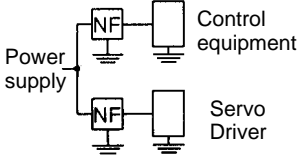
Countermeasure	Purpose	Precautions	Wiring
Noise filter	Attenuation of high-frequency energy	Apply noise filters to power supply lines so that the noise filters will perfectly separate control and power lines.	

■ Electromagnetic Inductive Path

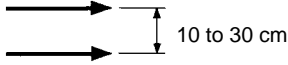
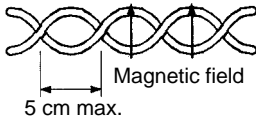
Countermeasure	Purpose	Precautions	Wiring
Separation of signal lines	Reduction of magnetic force	Keep signal lines at least 10 cm away from each other. Ideally, the signal lines are kept 30 cm away from each other.	
Twisted-pair wires for signal and return lines	Reduction of area influenced by magnetic field Cancellation of magnetic field by wires twisted opposite to each other	The twisted-pair wires must not be more than 5 cm long. Power and signal lines must be different to each other in twisting pitch.	 The magnetic field is canceled by wires twisted opposite to each other.

■ Radio Transmission Path

Countermeasure	Purpose	Precautions	Wiring
Noise filter	Attenuation of high-frequency energy	The section not attenuating high-frequency noise should be made as short as possible.	<p>Power supply</p> <p>Servo Driver</p> <p>Short in distance</p>
Shielding with conductive materials	Reduction of capacitive coupling	Be sure to connect the shield to the FG (frame ground). Ground only one end of the shield. The shield must be free of any current flow.	<p>Power supply</p> <p>Servo Driver</p>

Note The noise filter on the Servo Driver output side must be a dedicated noise filter that does not use a capacitor.

■ Current Leakage

Countermeasure	Purpose	Precautions	Wiring
Noise filter	Attenuation of high frequency energy of common mode (between the power line and FG).	Use a noise filter that eliminates common mode noise. At the very least, the control equipment must use the noise filter.	<p>Control equipment</p> <p>Power supply</p> <p>Servo Driver</p> <p>Noise filter eliminating common mode noise.</p> <p>As short as possible to the ground.</p>
Ground with a short, thick wire	Purging leakage current quickly to reduce voltage changes.	Use wire of 2.0 mm ² or more. The wiring distance must be as short as possible. Ground each wire at a resistance of less than 100 Ω.	

4-2-3 Other Countermeasures

If Servo System errors still result after all countermeasures described above, the following may be effective for some Position Control Unit and Servo Driver models.

● Positioning Point Deviation (Position Control Unit with Pulse Output)

Error

Command pulse input is subjected to noise interference and the Servo Driver handles the noise as command pulses.

Countermeasures

Separating the power supply.

Use a dedicated power supply for the pulse output of the Position Control Unit.

Separate the ground line.

Shielding the pulse signal.

If positioning point deviation results after power supply separation, connect both ends of the shield of the command pulse signal lines (twisted-pair shield wires) on the Position Control Unit and Servo Driver sides to the FG (frame ground).

Note Ground the Position Control Unit and Servo Driver at a resistance of less than 100 Ω . Incorrect grounding has a worse influence on the Servo System.

Applicable Models

C200H-NC112/NC211, C500-NC111-EV1

● Positioning Point Deviation (Position Control Unit with Analog Output)

Error

The encoder's feedback pulse signals subjected to noise interference and the Position Control Unit handles the noise as feedback pulses.

Countermeasures

Shielding the feedback pulse signals.

Connect both ends of the shield of the feedback pulse signal lines (twisted-pair shield wires) on the Position Control Unit and Servo Driver sides to the FG.

Note Ground the Position Control Unit and Servo Driver at a resistance of less than 100 Ω . Incorrect grounding has a worse influence on the Servo System.

Applicable Models

C500-NC103/NC222-E

● Speed Error (R Series Only)

Error

The serial communications block between the Servo Driver and encoder is subjected to noise interference. Therefore, a speed error is detected by mistake even though the rotation speed is not high. This error will occur if the motor is mounted to a movable part and the motor frame is not perfectly grounded.

Countermeasures

Ground the motor frame.

Connect the motor frame to the FG of the machine system. Then ground the FG at a resistance of less than 100 Ω .

Shield the encoder signal wires.

Connect both ends of the shield of the encoder cable (twisted-pair shield wires) on the Servo Driver and motor sides to the FG.

Note Ground the Servo Driver and motor at a resistance of less than 100 Ω . Incorrect grounding has a worse influence on the Servo System.

● Motor Vibration (M Series Only)**Error**

The resolver signal is subjected to noise interference and the motor vibrates because the electric potential of the FG (frame ground) of the motor is unstable.

Countermeasures

Connect the motor frame and the FG of the Servo Driver with a cable of 2.0 mm² or more in thickness.

● Incorrect Grounding**Error**

If a ground wire is not grounded correctly at a resistance of less than 100 Ω, the ground wire will generate noise. If the noise cannot be reduced, check the electric potential of the ground.

Countermeasures

Ground the wire in a different place where the wire can be grounded at a resistance of less than 100 Ω. Improve the present grounding condition.

Separate the FG of high-power equipment from that of low-power equipment.

Do not ground the FG lines of the control equipment and other equipment in use.

Cut the shield of the cable.

This should be taken as the last resort, in which case, however, the Servo System will not be able to fulfill its functions because of such poor operating conditions.

4-2-4 Noise Suppression Example**● Phenomena**

Positioning deviation results in a system in which the C200H-NC112 Position Control Unit, U-series AC Servomotor, and U-series Servo Driver are connected. Positioning is possible but the stop position will deviate in this system.

● Countermeasures**[a] Power Supply to Servo Driver and FG**

- Connect a noise filter to the power lines and reduce the length of the power lines to the system as much as possible.
- Connect the FG (frame ground) to the ground plate through a wire of 2 mm² or more in thickness.

[b] Servo Motor FG

- Connect the FG to the machine ground through a wire of 3.5 mm² or more in thickness.

[c] Power Supply to C200H and FG

- Connect a noise filter to the power lines.
- Connect the FG to the ground plate.

[d] Power Supply for Position Control Unit's Command Pulse Use

- Use a dedicated power supply for command pulse use.
- Connect a noise filter to the input side of the power supply.

[e] Command Pulse Signal Lines

- Use twisted-pair shield wires for the command pulse signal lines.
- The wires must not be longer than 1 m.
- Keep the wires approximately 30 cm away from other signal or power lines. Lay out the wires separately from other signal or power lines.

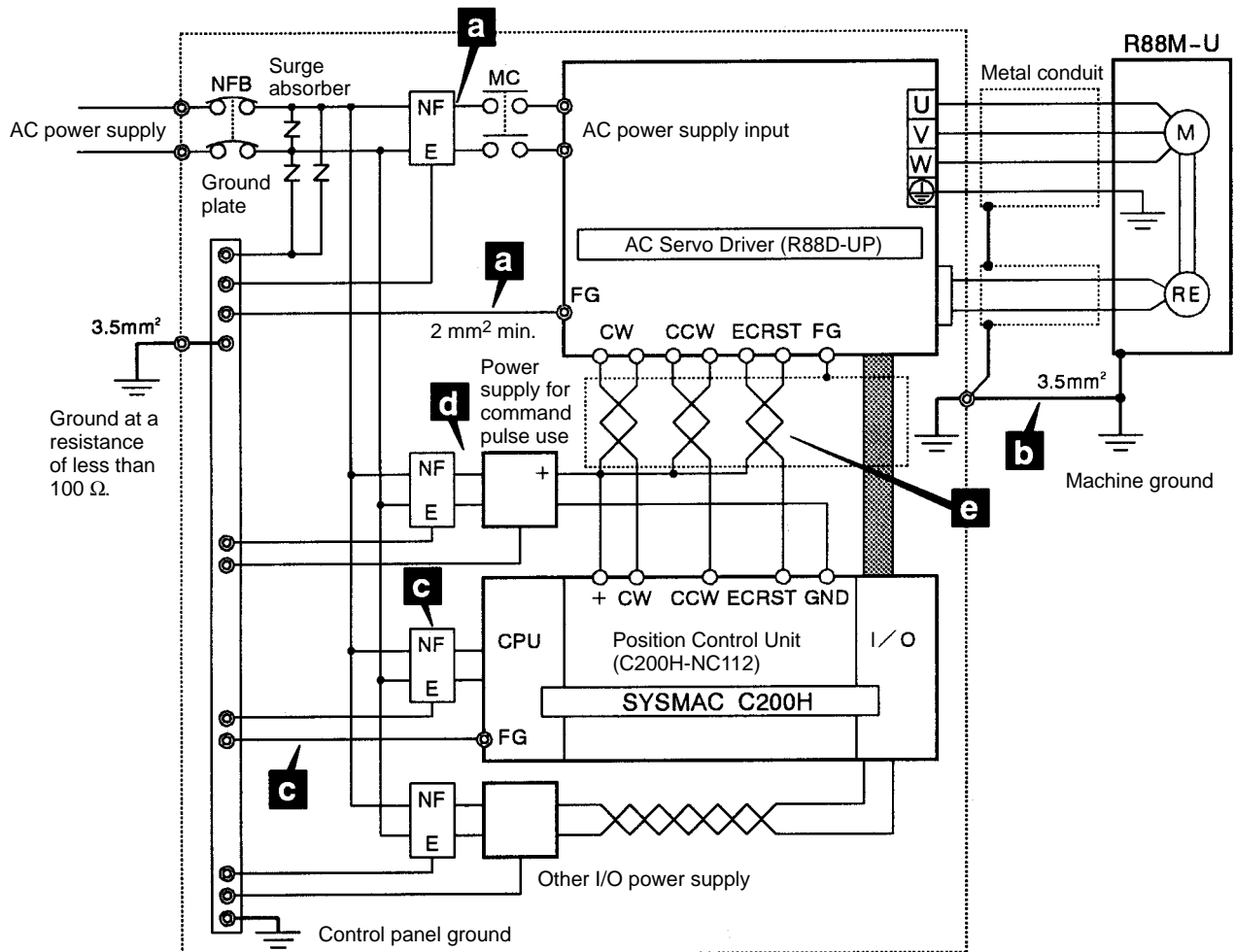

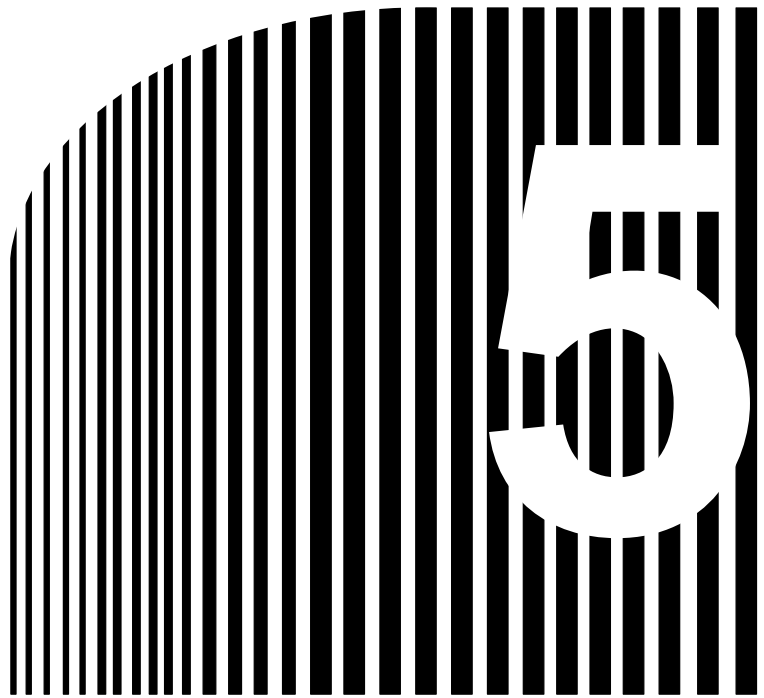

Chapter 5

• Appendix •

5-1 Configuration of Main Circuitry

5-1 Configuration of Main Circuitry

The following is an example of the configuration of the Servo Driver's main circuitry.

If an error should result, use this circuit diagram along with the information in *3-1 Alarms and Countermeasures* to determine which part of the circuit is the cause of the error.

