

K3NR

Frequency/Rate Meter

OPERATION MANUAL

OMRON

K3NR Frequency/Rate Meter



Operation Manual

Revised February 2001

Notice:

OMRON products are manufactured for use according to proper procedures by a qualified operator and only for the purposes described in this manual.

The following conventions are used to indicate and classify precautions in this manual. Always heed the information provided with them. Failure to heed precautions can result in injury to people or damage to the product.

-  **DANGER** Indicates information that, if not heeded, is likely to result in loss of life or serious injury.
-  **WARNING** Indicates information that, if not heeded, could possibly result in loss of life or serious injury.
-  **Caution** Indicates information that, if not heeded, could result in relatively serious or minor injury, damage to the product, or faulty operation.

OMRON Product References

All OMRON products are capitalized in this manual. The word “Unit” is also capitalized when it refers to an OMRON product, regardless of whether or not it appears in the proper name of the product.

The abbreviation “Ch,” which appears in some displays and on some OMRON products, often means “word” and is abbreviated “Wd” in documentation in this sense.

The abbreviation “PC” means Programmable Controller and is not used as an abbreviation for anything else.

Visual Aids

The following headings appear in the left column of the manual to help you locate different types of information.

Note Indicates information of particular interest for efficient and convenient operation of the product.

1, 2, 3... 1. Indicates lists of one sort or another, such as procedures, checklists, etc.

© OMRON, 1998

All rights reserved. No part of this publication may be reproduced, stored in a retrieval system, or transmitted, in any form, or by any means, mechanical, electronic, photocopying, recording, or otherwise, without the prior written permission of OMRON.

No patent liability is assumed with respect to the use of the information contained herein. Moreover, because OMRON is constantly striving to improve its high-quality products, the information contained in this manual is subject to change without notice. Every precaution has been taken in the preparation of this manual. Nevertheless, OMRON assumes no responsibility for errors or omissions. Neither is any liability assumed for damages resulting from the use of the information contained in this publication.

TABLE OF CONTENTS

PRECAUTIONS	xi
1 General Precautions	xii
2 Safety Precautions	xii
3 Application Precautions	xii
4 Noise Prevention	xiii
SECTION 1	
Introduction	1
1-1 Features	2
1-2 Front of the Meter	4
1-3 Rear of the Meter	7
1-4 Modes	8
1-5 Communications Function	9
SECTION 2	
Setup	11
2-1 Mounting	12
2-2 Input Block	13
2-3 Output Board	16
SECTION 3	
Operating Modes	21
3-1 Rotational/Circumferential Speed: F1	22
3-2 Absolute Ratio: F2	25
3-3 Error Ratio: F3	28
3-4 Rotational Difference: F4	31
3-5 Flow Rate Ratio: F5	34
3-6 Passing Time: F6	37
3-7 Pulse Counting: F7	40
SECTION 4	
Parameter Setting	45
4-1 Overview	46
4-2 Setting Mode	47
4-3 Protect Mode	88
SECTION 5	
Operations in RUN Mode	99
5-1 Displaying and Changing Setting Values	100
5-2 Displaying and Resetting of Maximum and Minimum Values (Operating Modes F1 to F6)	103
5-3 External Input Signals	104
SECTION 6	
Useful Functions	107
6-1 Teaching Function	108
6-2 Output Test	112
6-3 Maintenance Mode	113

TABLE OF CONTENTS

SECTION 7	
BCD Output	115
7-1 Connectors	116
7-2 Timing Charts	119
SECTION 8	
Troubleshooting	121
8-1 Items to Be Checked First	122
8-2 Display	122
Appendices	
A Specifications	125
B Estimated Frequency Calculation	129
C List of Settings	131
D Available Models	133
E Available Parameters	135
F Setting Examples	139
Index	141
Revision History	145

About this Manual:

This manual describes the installation and operation of the K3NR Frequency/Rate Meter and includes the sections described below.

Please read this manual carefully and be sure you understand the information provided before attempting to install and operate the K3NR.

Section 1 describes the functions of the K3NR. The main components are also described.

Section 2 provides instructions required for mounting and wiring the K3NR.

Section 3 provides instructions for setting the parameters of the K3NR.

Section 4 provides instructions for operating the K3NR in RUN mode.

Section 5 provides information on the teaching function, output test, and maintenance mode.

Section 6 provides information on the use of the K3NR with the BCD Output Board.

Section 7 provides information for troubleshooting the K3NR

The **Appendices** provide specifications, a list of settings, a list of standard models, and a list of available menu items.



WARNING Failure to read and understand the information provided in this manual may result in personal injury or death, damage to the product, or product failure. Please read each section in its entirety and be sure you understand the information provided in the section and related sections before attempting any of the procedures or operations given.

PRECAUTIONS

This section provides precautions for using the K3NR Frequency/Rate Meter and related devices.

The information contained in this section is important for the safe and reliable application of the K3NR. You must read this section and understand the information contained before attempting to set up or operate the K3NR.

1 General Precautions	xii
2 Safety Precautions	xii
3 Application Precautions	xii
4 Noise Prevention	xiii

1 General Precautions

The user must operate the product according to the performance specifications described in the operation manuals.

Before using the product under conditions which are not described in the manual or applying the product to nuclear control systems, railroad systems, aviation systems, vehicles, combustion systems, medical equipment, amusement machines, safety equipment, and other systems, machines, and equipment that may have a serious influence on lives and property if used improperly, consult your OMRON representative.

Be sure to read this manual before attempting to use the product and keep this manual close at hand for reference during operation.

2 Safety Precautions

 **WARNING** Never attempt to disassemble any Units while power is being supplied. Doing so may result in serious electrical shock or electrocution.

 **WARNING** Never touch any of the terminals while power is being supplied. Doing so may result in serious electrical shock or electrocution.

3 Application Precautions

Observe the following precautions when using the product.

- Always use the power supply voltage specified in the specifications.
- Do not use the product in locations subject to flammable gases or combustible objects.
- Be sure to confirm terminal names when wiring.
- Be sure to tighten the screws on the terminal blocks.

Observe the following precautions when mounting the product.

- Mount the product on level surfaces.
- Mount the product on a panel which has a thickness of 1 to 3.2 mm.

Do not mount the product in the following places.

- Locations subject to strong shock or vibration.
- Locations subject to temperature or humidity exceeding the rated levels or where icing is liable to occur.
- Locations subject to dust.
- Locations subject to corrosive gases (particularly sulfuric gases or ammonium gases).
- Locations subject to direct sunlight or outdoor conditions.
- Locations near devices (high-frequency welders or high-frequency sewing machines) that produce high-frequency noise.

4 Noise Prevention

Provide the following countermeasures when using the product in an environment where the product is exposed to noise.

- Countermeasures for protecting the product against high-frequency noise or abnormal voltages.

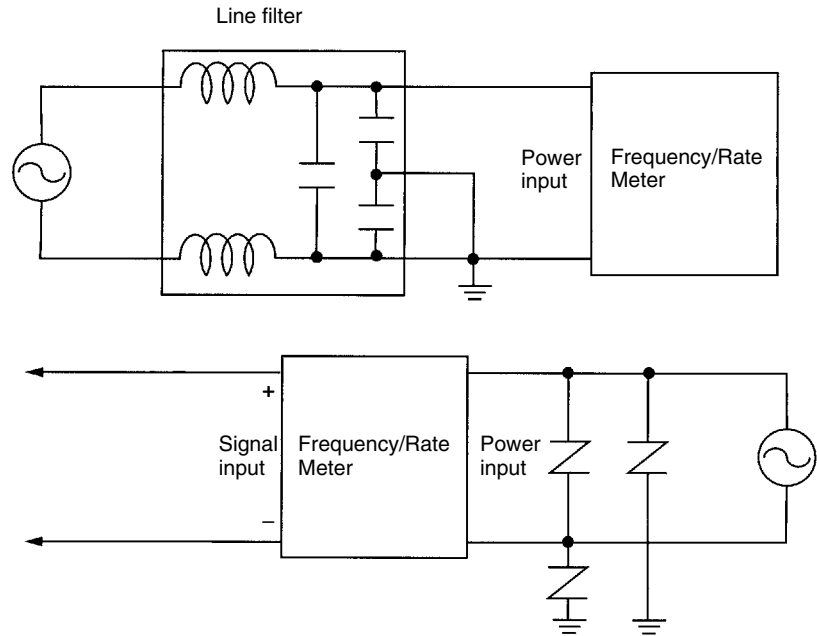

- Countermeasures for protecting the product against inductive noise produced from the input line.

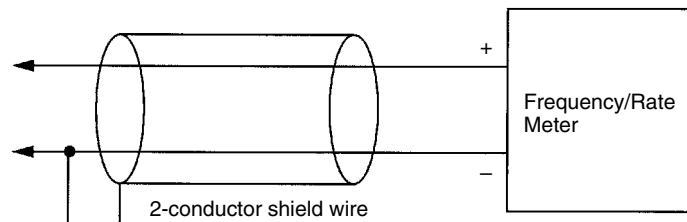

SECTION 1

Introduction

This section describes the functions of the K3NR. The main components are also described. Refer to the remaining sections of this manual for the operation of the K3NR and its menus in detail.

1-1	Features	2
1-2	Front of the Meter	4
1-3	Rear of the Meter	7
1-4	Modes	8
1-5	Communications Function	9

1-1 Features

The K3NR Frequency/Rate Meter displays desired values after converting input pulses.

The K3NR has the following functions.

Operating mode	Function
1	Displays rotational or circumferential speed of a single input.
2 to 5	Displays the calculation results of two rotational inputs.
6	Displays passing time calculated from the frequency and process length of a single input.
7	Counts and displays the number of pulses.

Measurement

The internal system clock counts the ON/OFF time (T) of sensor input or other input and automatically calculates the frequency. The number of revolutions is calculated from the result of the frequency multiplied by 60.

Sensor input pulse ON/OFF time (T) = 

$$\text{Frequency (f)} = \frac{1}{T}$$

- Rotational speed (rpm) = f x 60
- Circumferential speed = Circumference x revolutions
- Passing time = Length of processing/Circumferential speed
- Pulse counting

If there is any pulse input, the input will be automatically converted numerically and displayed.

Prescaling

The number of input pulses is converted into a desired value.

Enables the K3NR to display the revolutions or rotational speed. It is necessary to multiply the number of pulses per revolution or circumference by a certain factor. This factor is called the prescaling value.

Example:

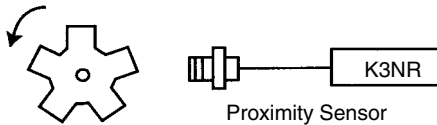

$$\text{rpm} = f \times 60 \times a$$

f: Input pulse frequency (number of pulses per second)
a: Prescale value
If there are five pulses per rotation, the accurate rotational speed can be calculated if a = 1/5 (– 0.2=2 x 10⁻¹).

Comparative Output Selection

Comparison output patterns can be selected from the standard, level, or zone output depending on the application.

Refer to *Comparative Output Patterns*, page 80.

Linear Output

Refer to *Linear Output Range*, page 83.

BCD Output

A digital data output format where every four binary bits is numerically equivalent to one decimal digit.

Refer to *Section 7 BCD Output*.

Communications Output

Refer to the *Communications Manual*.

HOLD

HOLD is an external input which is used to stop the A/D process and freeze the display. The comparative, linear, and BCD outputs are also retained.

Refer to *5-3 External Input Signals* for details.

RESET	<p>RESET is an external input to reset the present max./min. values and counting values. The process value when the RESET is ON is set as the maximum and minimum values. The counting value is reset to zero. The max./min. values and counting values can be reset using the front panel keys.</p> <p>Refer to pages 104 and 105.</p>
Teaching	<p>The K3NR is provided with a teaching function that can set an actual measured value as a setting value without key input.</p> <p>This function is useful for setting parameters while checking the operating status of the K3NR.</p> <p>The teaching function can be used to set the set and prescaling values. It can be also used to set the linear output range of the K3NR with a Linear Output Board.</p> <p>Refer to <i>6-1 Teaching Function</i> for details.</p>
Output Test	<p>This function is convenient for checking a system to which the K3NR is connected, especially when some inputs cannot be operated. The K3NR simulates an input to check the output conditions.</p> <p>Refer to <i>6-2 Output test</i> for details.</p>
Hysteresis	<p>The established setting value includes a hysteresis setting to prevent “chattering” of the output when the measured value fluctuates in the vicinity of the setting values.</p> <p>Hysteresis is enabled when the measured value is starts to become smaller than the HH and H setting values and larger than the LL and L setting values.</p> <p>Refer to <i>Hysteresis</i>, page 78.</p>
Startup Compensation Time	<p>The startup compensation time parameter keeps the measurement operation from sending an unnecessary output corresponding to instantaneous, fluctuating input from the moment the K3NR is turned ON until the end of the preset period.</p> <p>Refer to <i>Startup Compensation Time</i>, page 74.</p>
Remote/Local Selection	<p>The K3NR can be operated remotely through a host computer or locally with key inputs.</p> <p>Remote Mode: For programming remotely by downloading setup parameters from a host computer via RS-232C, RS-485, or RS-422.</p> <p>Local Mode: Programming is performed with the front panel key input.</p> <p>Refer to <i>Remote/Local Programming</i>, page 86.</p>
Process Time for Averaging Measured Value	<p>Setting process time for averaging measured value prevents the display from fluctuating due to unstable input.</p> <p>Refer to <i>Process Time for Averaging Measured Value</i>, page 72.</p>
Auto-Zero Time	<p>The input pulse frequency does not drop to zero perfectly due to the estimated frequency calculation of the K3NR. Therefore, the K3NR has a function to calibrate the frequency to zero forcibly should no input pulse be received for a certain period. The period during which no pulse is received before the K3TR sets the frequency to zero is called “auto-zero time.”</p> <p>Refer to page 62.</p>

1-2 Front of the Meter

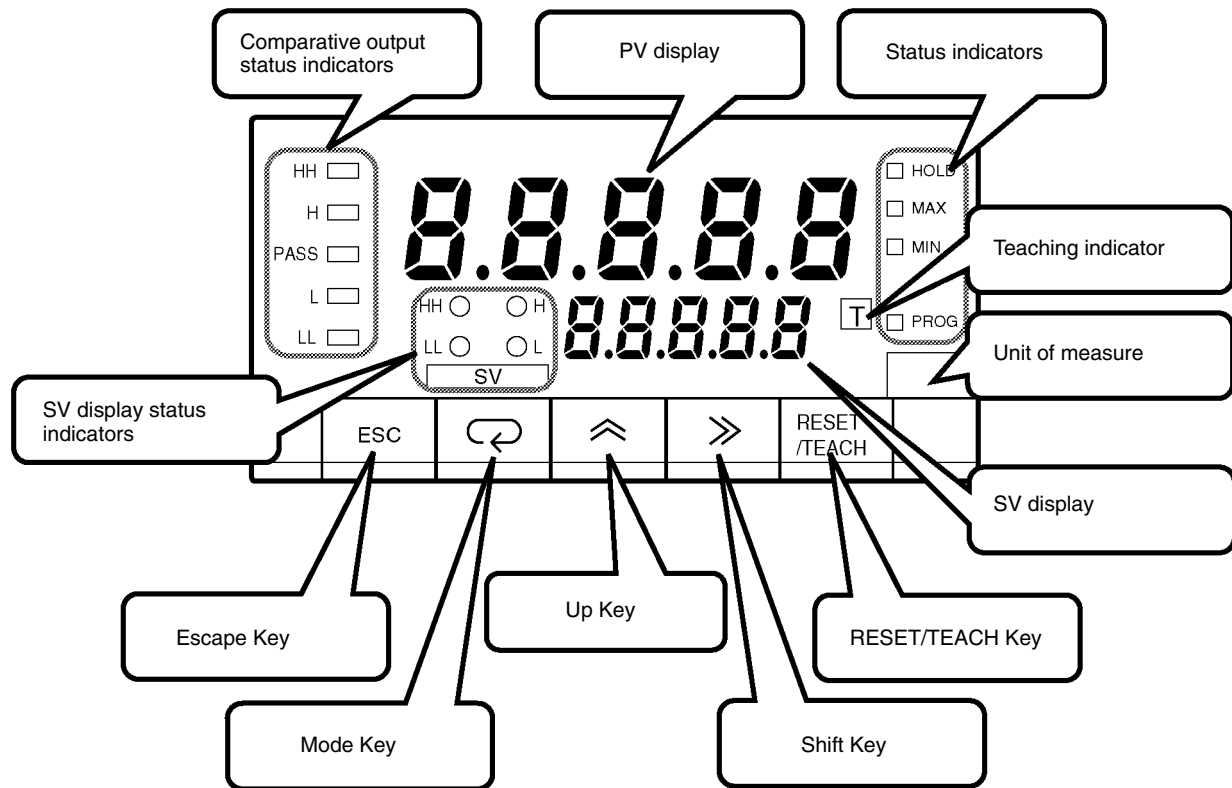

Five-digit (–19999 to 99999), seven-segment, 14.2-mm-high LED display with a programmable decimal point.

The displays show the process value, maximum value, minimum value, operations/parameters when setting, and error messages.

PV Display

K3NR-□□□A Basic Model

RUN Mode: Displays the process, maximum, and minimum values. Also displays setting values while the SV indicator is lit. When changing a value, all digits other than those that can be set become dimmer.

Setting Mode: Displays the menu, parameter, or setting value. When changing a value, all digits other than those that can be set become dimmer.

K3NR-□□□C Set Value LED Display Model

RUN Mode: Displays the process, maximum, and minimum values.

Setting Mode: Displays the menu and parameters.

SV Display (Setting value LED Display Models Only)

RUN Mode: Displays comparative set values. When changing a value, all digits other than those that can be set become dimmer.

Setting Mode: Displays setting values. When changing a value, all digits other than those that can be set become dimmer.

Comparative Output Status Indicators

Indicates the status of the comparative output.

Status Indicators

HOLD Indicator

Lit when the HOLD input signal is ON.

MAX Indicator

Lit when the value displayed on the PV display is the maximum value.

MIN Indicator

Lit when the value displayed on the PV display is the minimum value.

PROG Indicator

Lit when the setting mode menu is displayed. The indicator flashes while parameters are displayed.

Teaching Indicator

Lit when displayed parameters can be set in teaching operation. The indicator flashes when the process value is indicated as a setting value.

SV Display Status Indicators

Indicates which set value is on the PV or SV display.

Unit of Measure

Attach the appropriate label showing the unit of measure (enclosed).

Escape Key



Used to select the process, maximum, or minimum value to be displayed on the PV display in RUN mode.

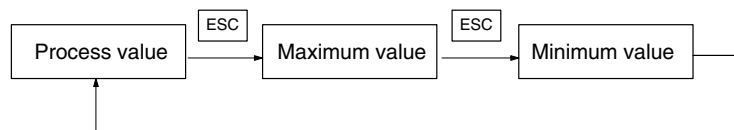

Used to return from the setting, protect, or maintenance mode to the RUN mode. This key is also used to return to the previous operation during the setting, protect, or maintenance mode.

Mode Key



Displays a setting value (out of HH, H, L, and LL setting values in this order) on the PV display in RUN mode when this key is pressed. Unless another operation key is pressed within five seconds after this key has been pressed, the display automatically changes to the one for process values.

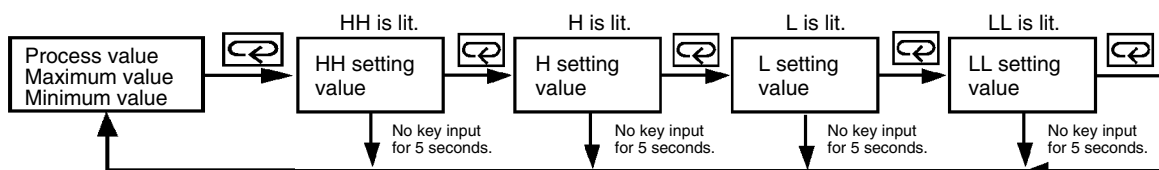

In the RUN mode, this button terminates the measurement process and allows you to enter the setting mode, advancing through the menus and parameters.

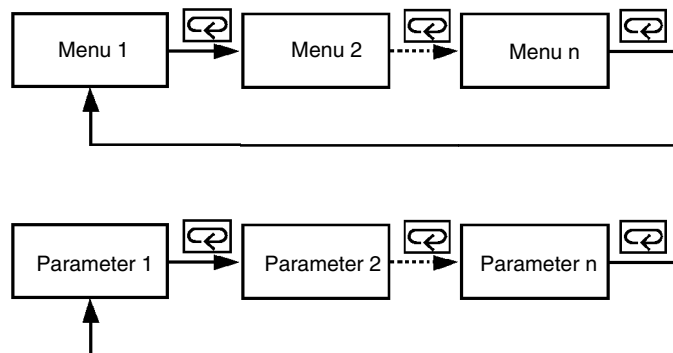

In the setting mode, this button will store changes in the non-volatile memory while at the same time advancing the display to the next menu item.

Up Key



Used to select a parameter to be displayed for setting value change.

Used to increment the current digit in the setting value by one.

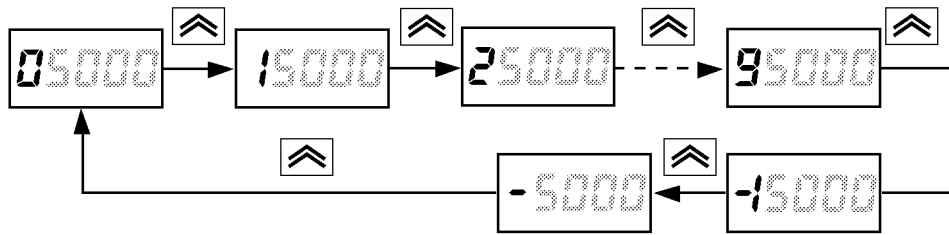

The value increases in the following order:

0, 1, 2, 3, 4, 5, 6, 7, 8, 9, (-1), and (-)

Only the leftmost digit will be displayed if the value is set to “-1” or “-.”

The value will be set to 0 if this key is pressed when “9” or “-” is displayed.

Shift Key



Used to change the parameter displayed in setting mode.

Used to scroll the digit to the right of the presently displayed digit.

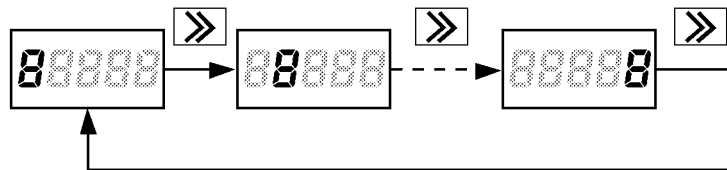

RESET/TEACH Key



Used to reset the maximum value, minimum value, or counting value in RUN mode.

Used to select the teaching function. Refer to 6-1 Teaching Function for details.

1-3 Rear of the Meter

Terminal arrangement varies depending on the selected Output Board.
For wiring, refer to *Section 2 Setup*.

- K3NR with Relay Output Board, K31-C1, -C2, -C5
- K3NR with Transistor Output Board, K31-T1, -T2
- K3NR with Linear Output Board, K31-L1, -L2, -L3, -L4, -L5, -L6, -L7, -L8, -L9, -L10
- K3NR with RS-485 Output Board, K31-FLK2, -FLK5

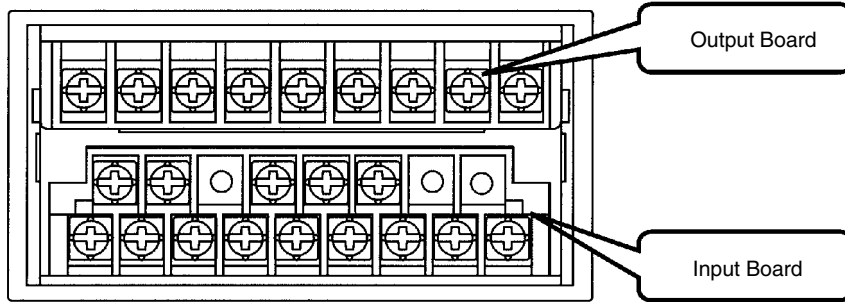

K3NR with BCD Output Board, K31-B2, -B4

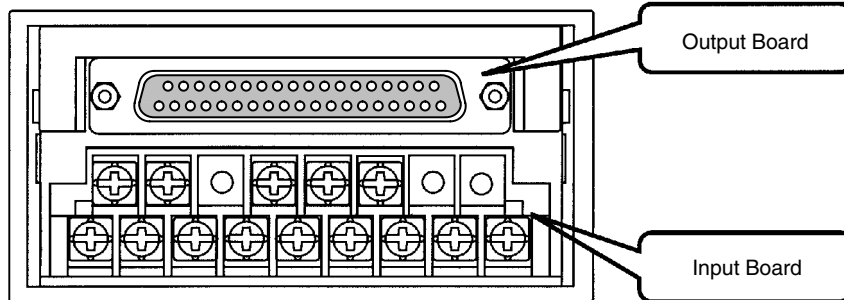

K3NR with RS-232C Output Board, K31-FLK1

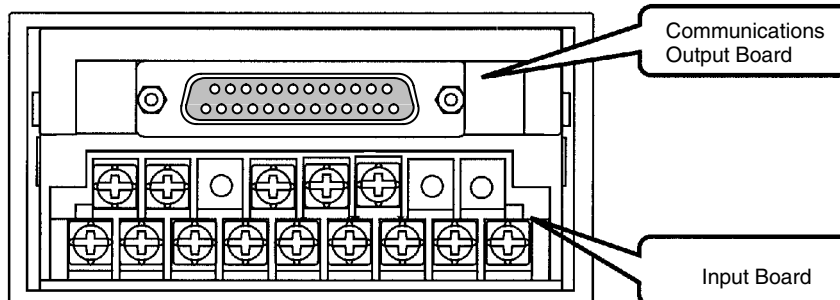

K3NR with RS-422 Output Board, K31-FLK3

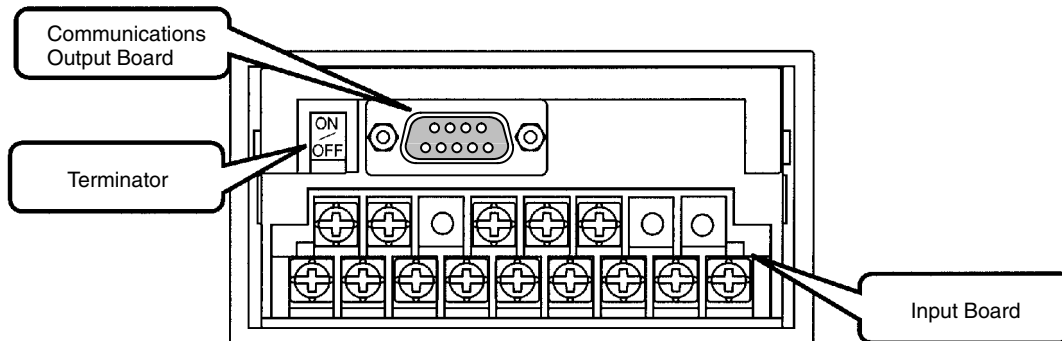

K3NR with RS232C + Transistor Output Board, K31-FLK4
K3NR with RS-422 + Transistor Output Board, K31-FLK6

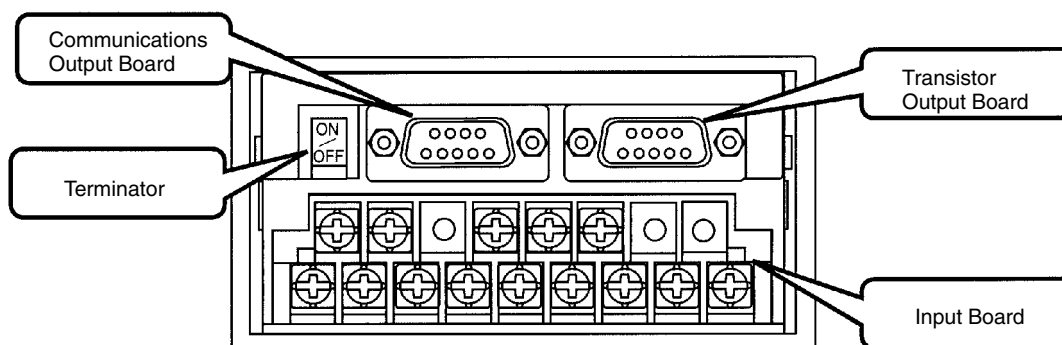

1-4 Modes

The following four modes are available.

- RUN mode for normal operations (see *Section 5 Operations in RUN Mode*)
- Setting mode for initializing parameter input (see *Section 4 Parameter Setting*)
- Protect mode for lock-out configuration (see *4-1 Protect Mode*)
- Maintenance mode for initialization (see *6-3-2 Initialization*)

Refer to the following for the relationship among these modes and selection of the modes.

Press the Mode and Shift Keys while turning on the K3NR.

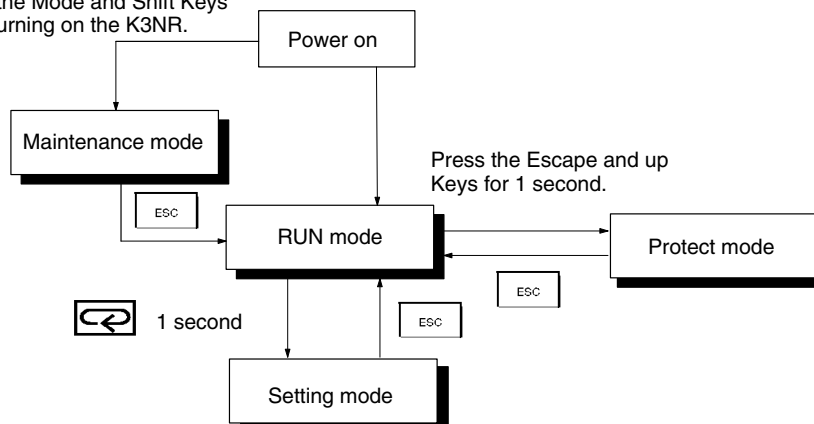

RUN Mode

K3NR is in RUN when the K3NR is turned ON.

The K3NR in this mode provides an output signal as a result of the comparison of the measured and setting values.

The basic model in this mode usually displays the process value. The maximum and minimum values are displayed by pressing the Escape Key. The parameters and setting values are displayed by pressing the Mode Key.

Refer to *Section 5 Operations in RUN Mode* for RUN mode in detail.

Setting Mode

Values are set in the K3NR in this mode by key input or using the teaching function.

Refer to *Section 4 Parameter Setting* for value setting by key input and *6-1 Teaching Function* for the teaching function in detail.

Protect Mode

Use this mode to prohibit some operations in order to lock out the setting values.

Refer to *4-1 Protect Mode* for details.

Maintenance Mode

The setting values are reset to factory-set values in this mode. Refer to *6-3-2 Initialization* for details.

1-5 Communications Function

The communications function of the K3NR makes it possible for the host computer to perform the following operations.

- Confirmation and change of setting values. Communications conditions cannot be changed.
- Reading and resetting the maximum and minimum values.
- Confirmation of model data.

Use a model with the Communications Board if the communications function is required.

Refer to the *Communications Manual* for the communications function in detail.

RS-232C

Use the K31-FLK1 or K31-FLK4 Output Board to use the RS-232C interface.

RS-422

Use the K31-FLK3 or K31-FLK6 Output Board to use the RS-422 interface.

RS-485

Use the K31-FLK2 or K31-FLK5 Output Board to use the RS-485 interface.

SECTION 2

Setup

This section provides instructions required for mounting and wiring the K3NR.

2-1	Mounting	12
2-2	Input Block	13
2-2-1	Terminal Arrangement	13
2-2-2	Wiring Precautions	14
2-2-3	Wiring	14
2-3	Output Board	16
2-3-1	Terminal Arrangement	16
2-3-2	Relay Output Board	18
2-3-3	Transistor and Combination Output Board	19
2-3-4	Linear Output Board	19
2-3-5	BCD Output Board	19

2-1 Mounting

Dimensions

All dimensions are in millimeters.

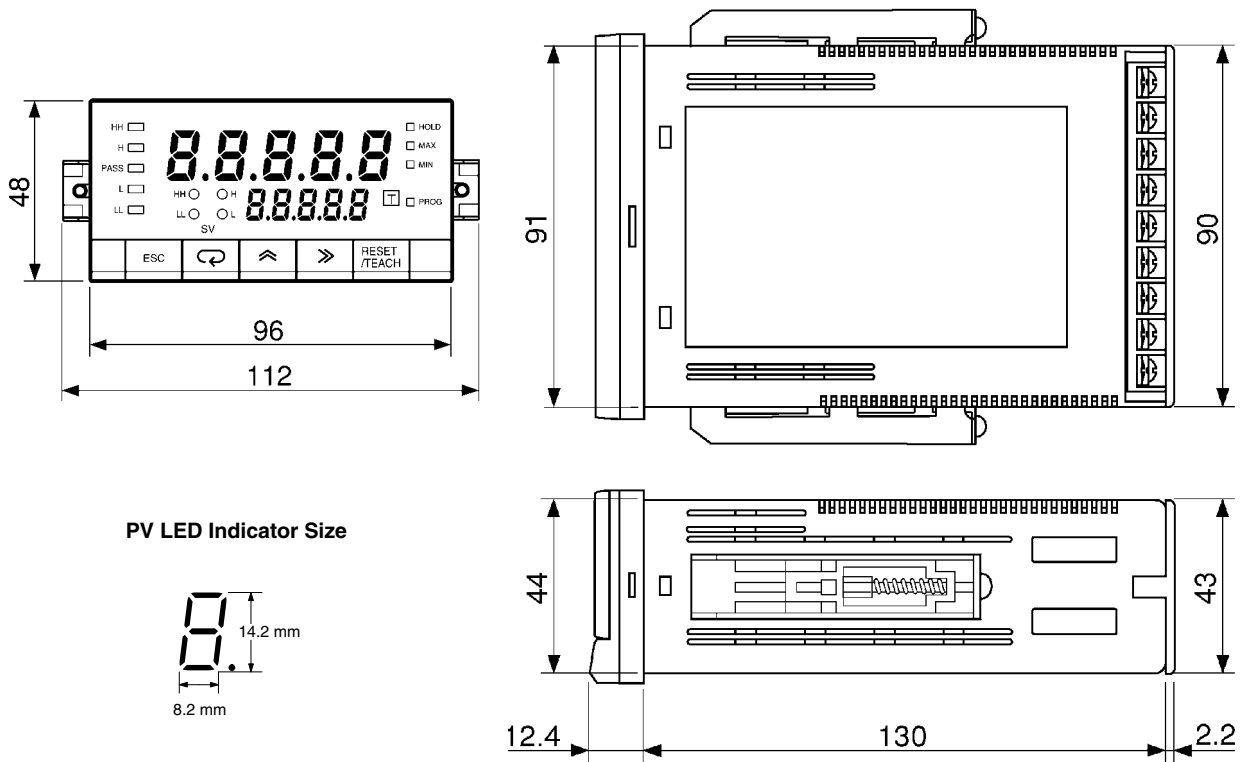

PV LED Indicator Size

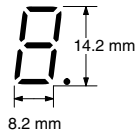

Panel Cutouts

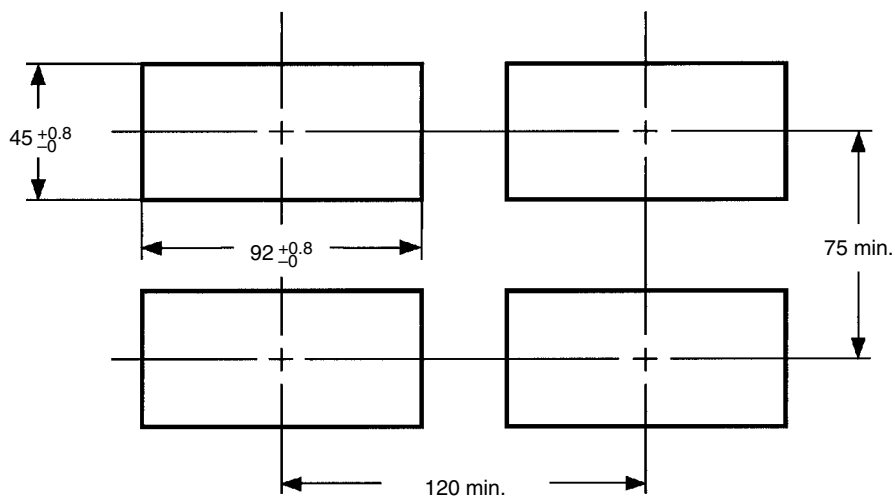

Recommended panel thickness is 1 to 3.2 mm.

Do not mount more than one Unit closely in the horizontal or vertical direction. Be sure to keep the distance between adjacent Units.

Mounting Method

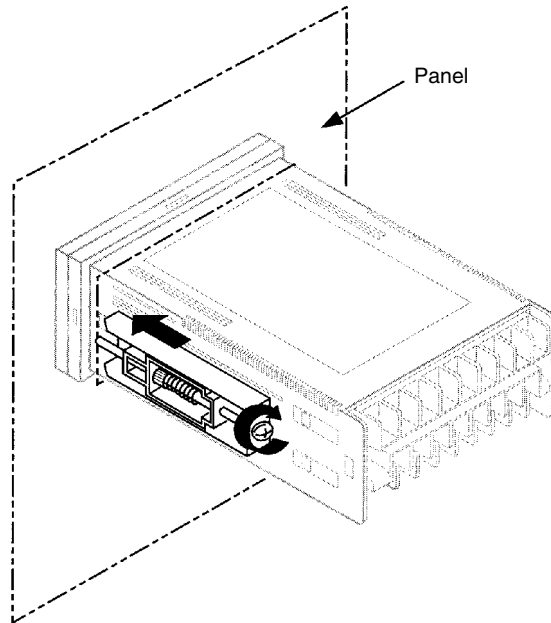

- 1, 2, 3...
1. Insert the K3NR into the mounting hole on the panel.
 2. Hook the fixture claws onto the side holes.
 3. Mount a fixing metal to the right and left sides as shown above and while keeping them in balance, alternately tighten each screw until the ratchet becomes idle.

2-2 Input Block

2-2-1 Terminal Arrangement

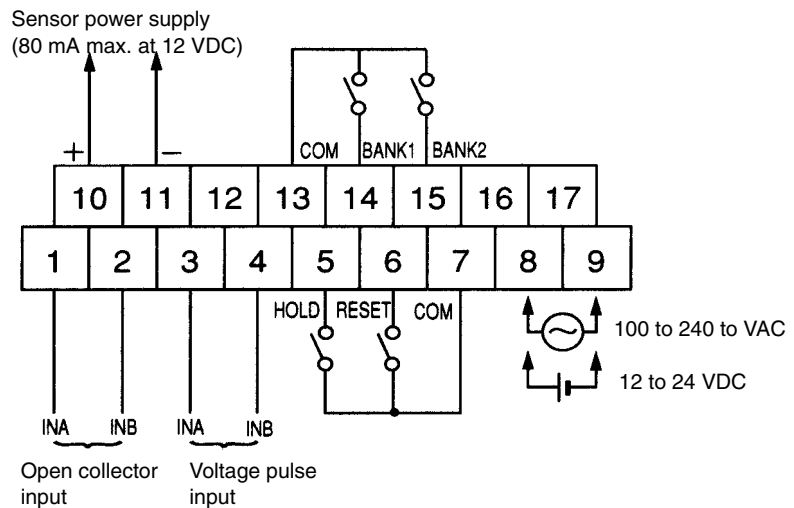

Note Voltage pulse input is available for the K3NR-NB□□-□□.

2-2-2 Wiring Precautions

- Do not make any mistake in polarity when supply DC power to the K3NR.
- Do not wire power lines alongside the signal lines of the K3NR in order to prevent the K3NR from noise interference.
- Wire the terminal block with crimp terminals.
- Tighten each screw to a torque of 0.78 N • m (8 kgf • cm).

2-2-3 Wiring

Power Supply

Apply 100 to 240 VAC or 12 to 24 VDC to terminals 8 and 9.

Open Collector Input

Connect the pulse output from sensor A to terminal 1.

Connect the pulse output from sensor B to terminal 2.

Terminals 10 and 11 are exclusively used for a power supply with an output of 80 mA at 12 VDC to sensor A or B. If power is supplied to the sensor A or B from a different power source, do not use terminal 10. Do not connect a sensor with open collector output to terminal 10.

Refer to the following for sensor connections.

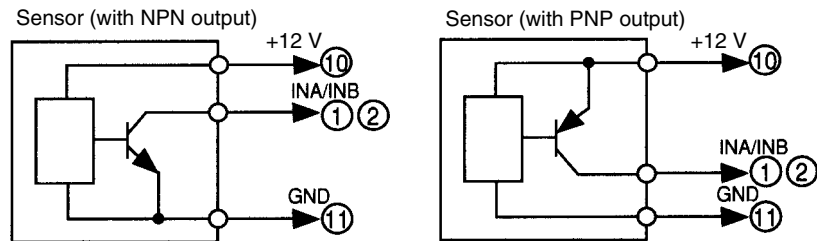

- Residual voltage with sensor turned on: 3 V max.
- Current leakage with sensor turned off: 1.5 mA max.
- Switching load current: 20 mA or greater. Must be able to dependably switch a load current of 5 mA max.

Photoelectric sensors, proximity sensors, rotary encoders, and relays can be connected as sensors to the K3NR.

Voltage Pulse Input

Connect the pulse output of sensor A to terminal 3.

Connect the pulse output of sensor B to terminal 4.

Terminals 10 and 11 are exclusively used for a power supply with an output of 80 mA at 12 VDC to sensor A or B. If power is supplied to the sensor A or B from a different power source, do not use terminal 10. Do not connect a sensor with voltage pulse output to terminal 10.

Refer to the following for sensor connections.

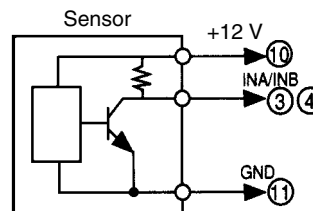

H level (sensor output ON): 4.5 to 30 VDC

L level (sensor output OFF): -30 to 2 VDC

Auxiliary Power Supply

Terminals 10 and 11 are exclusively used for power supply to sensors with an output of 80 mA at 12 VDC ± 10%.

External Signal Input

HOLD Input
RESET Input
BANK Input

Connect external signal inputs to terminals 5 through 7 and 13 through 15. Terminals 7 and 13 are connected to each other internally.

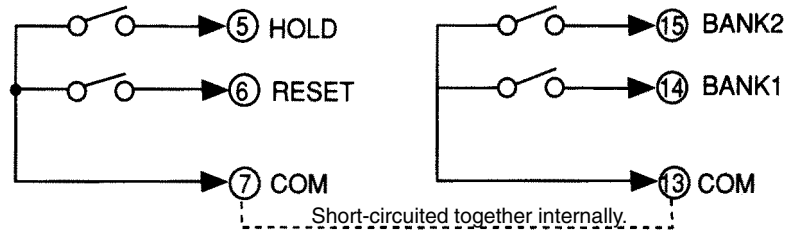

Connect HOLD input to terminal 5.

Connect RESET input to terminal 6.

Connect BANK inputs to terminals 14 and 15 for BANK1 and BANK2.

If open collector input is used as external signal input, the transistor must satisfy the following conditions.

- Residual voltage with transistor turned on: 3 V max.
- Current leakage with transistor turned off: 1.5 mA max.
- Switching load current: 20 mA or greater.

Approximately 5 V is imposed between COM and terminals 5 to 7 with a current flow of approximately 18 mA (a nominal value) at the time of external input short-circuiting.

2-3 Output Board

2-3-1 Terminal Arrangement

K3NR with Relay Output Board, K31-C1, -C2, -C5
 K3NR with Transistor Output Board, K31-T1, -T2
 K3NR with Linear Output Board, K31-L1, -L2, -L3, -L4, -L5, -L6, -L7, -L8, -L9, -L10
 K3NR with RS-485 Output Board, K31-FLK2, -FLK5

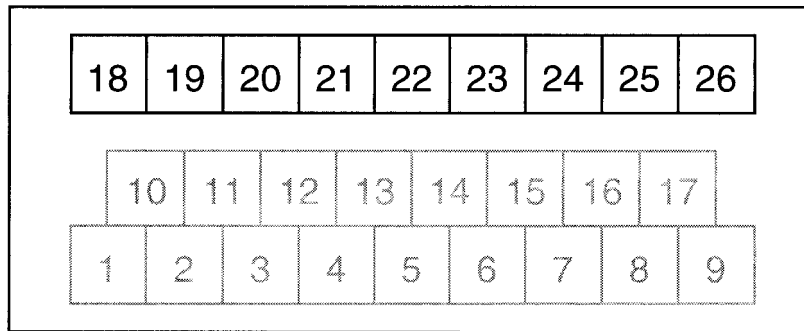

K3NR with BCD Output Board, K31-B2, -B4

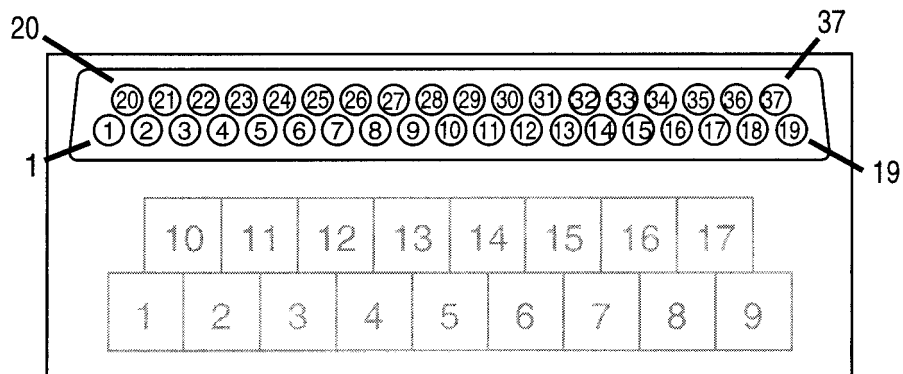

K3NR with RS232C + Transistor Output Board, K31-FLK4

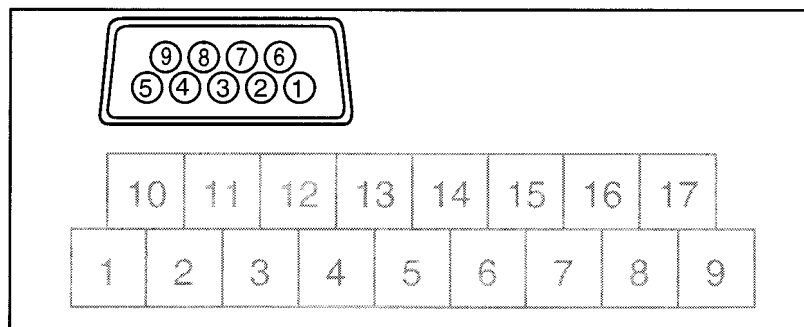

K3NR with RS-422 + Transistor Output Board, K31-FLK6

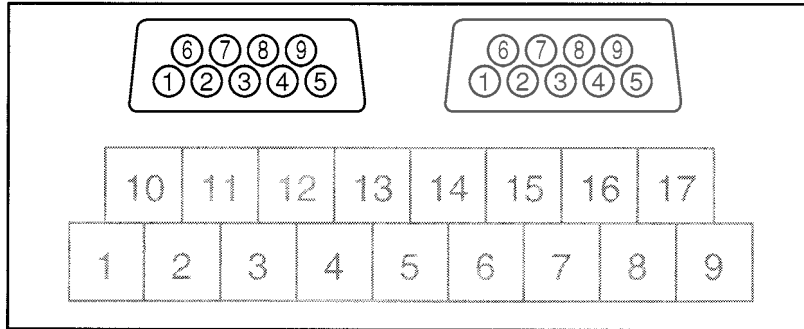

K3NR with RS-232C Output Board, K31-FLK1

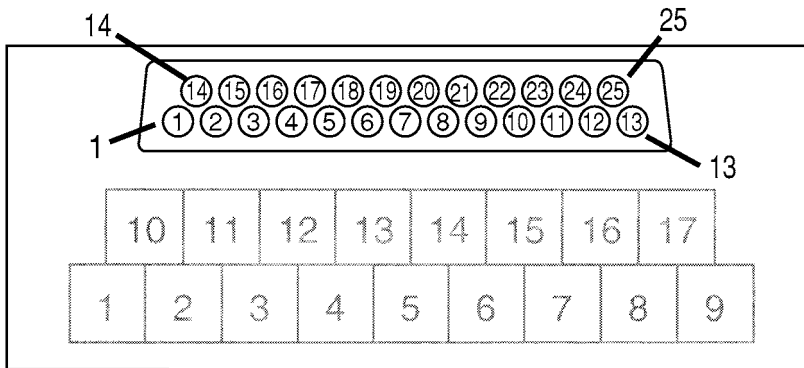

K3NR with RS-422 Output Board, K31-FLK3

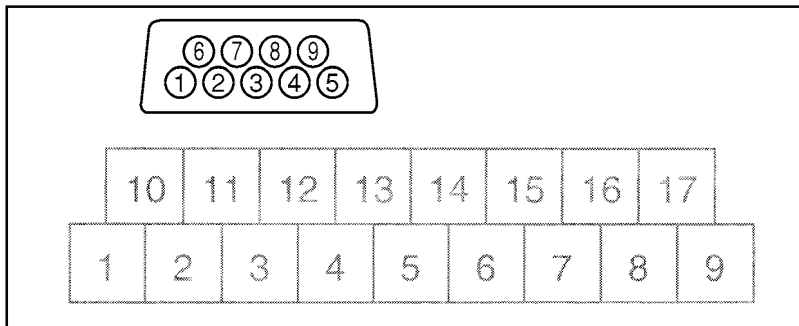

2-3-2 Relay Output Board

The following figures show the connections for relay output.

K3NR with 3 Relay Output Boards, K31-C1

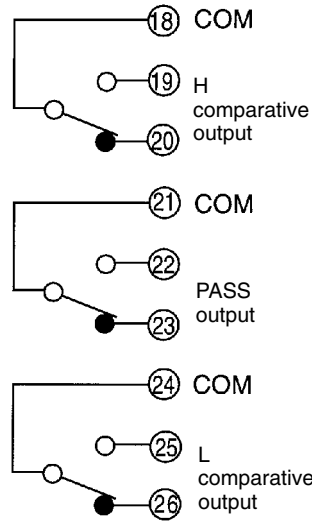

K3NR with 5 Relay Output Boards, K31-C2

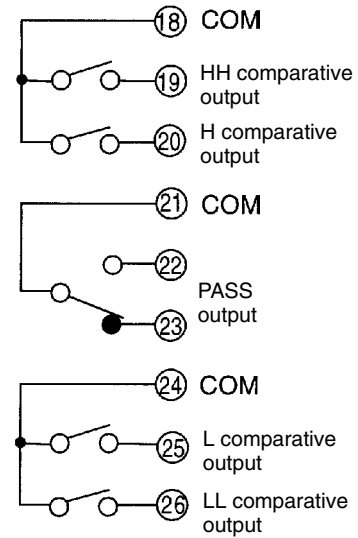

K3NR with 5 Relay Output Boards, K31-C5

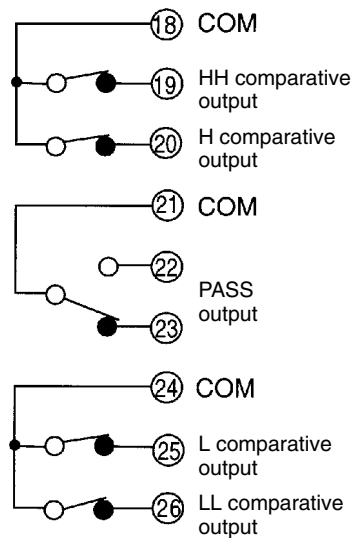

The following contact output conditions are required.

- 5 A (resistive load) at 250 VAC
- 1.5 A (inductive load) at 250 VAC
- 5 A (resistive load) at 30 VDC
- 1.5 A (inductive load) at 30 VDC

2-3-3 Transistor and Combination Output Board

K3NR with Transistor Output Board, K31-T1 or K31-T2

K3NR with Linear Output Board, K31-L4, -L5, -L6, -L9, -L10

K3NR with RS-485 + 5 Relay Output Boards, K31-FLK5

K3NR with BCD Output Board, K31-B2 or K31-B4

K3NR with RS232C + 5 Transistor Output Boards, K31-FLK4

K3NR with RS-422 + 5 Transistor Output Boards, K31-FLK6

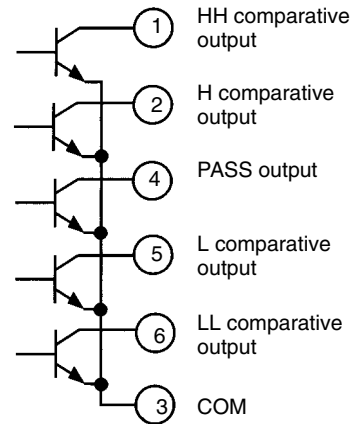
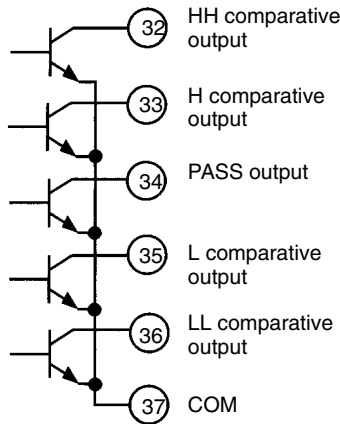
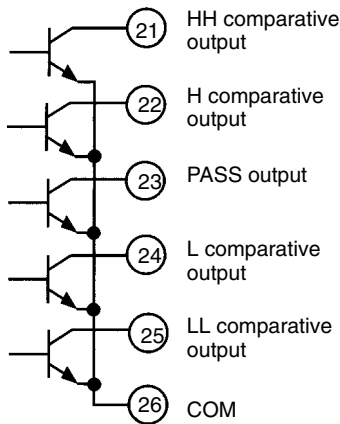

The following transistor output conditions are required.

Maximum rated voltage: 24 VDC

Load current: 50 mA

Current leakage with transistor turned off: 100 μ A

2-3-4 Linear Output Board

The following figures show connections for linear output.

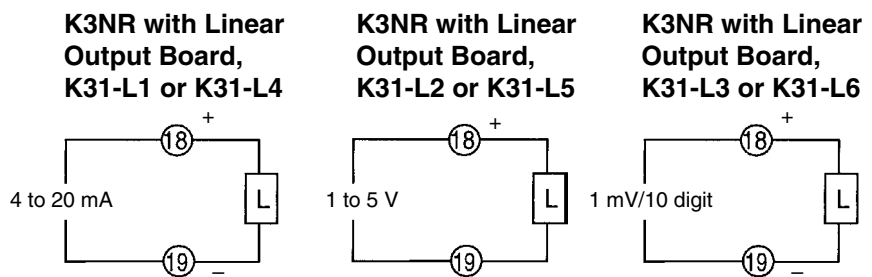

The following linear output conditions are required.

Linear output	Permissible load resistance	Resolution	Output error
4 to 20 mA	600 Ω max.	4096	$\pm 0.5\%$ FS
1 to 5 V	500 Ω min.	4096	$\pm 0.5\%$ FS
1 mV/10 digit	1 k Ω min.	4096	$\pm 1.5\%$ FS

2-3-5 BCD Output Board

Refer to *Section 7 BCD Output* for the terminal arrangement and interface.

SECTION 3

Operating Modes

This section provides information on the basic functions of each operating mode.

3-1	Rotational/Circumferential Speed: $F1$	22
3-2	Absolute Ratio: $F2$	25
3-3	Error Ratio: $F3$	28
3-4	Rotational Difference: $F4$	31
3-5	Flow Rate Ratio: $F5$	34
3-6	Passing Time: $F6$	37
3-7	Pulse Counting: $F7$	40

3-1 Rotational/Circumferential Speed: $F \downarrow$



FUNCTION

Application example

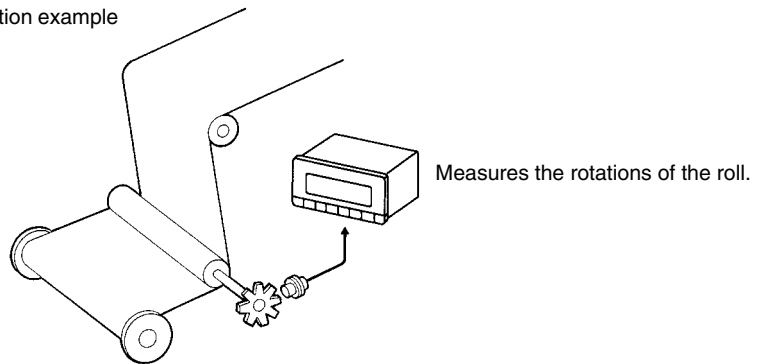

Basic Operation

Multiplies the input frequency (Hz) of INA by 60 and displays the result in rpm. When the appropriate prescale value is selected, the rotational speed of the object is displayed. Obtain display value D as follows:

$$D = f_A \times 60 \times \alpha$$

f_A : Input frequency of INA (Hz)

α : Prescale value

INB input will be ignored.



SETTING

Item	Unit of display	Prescale value
Rotations	rpm	1/N
	rps	1/60N
Frequency of input pulse	Hz	1/60
	kHz	1/60000
Rotational speed	mm/s	$1000\pi d/60N$
	cm/s	$100\pi d/60N$
	m/s	$\pi d/60N$
	m/min	$\pi d/N$
	km/h	$0.06\pi d/N$

Where,

N: Number of pulses per rotation

πD : Length (m) of one rotation

Example:

Displaying rotations (rpm) on condition that there are two pulses per revolution.

Prescaling value (α) = $1/2 = 0.5 = 5.0000 \times 10^{-1}$

Prescale value = $X \times 10^Y$ (X: mantissa, Y: exponent)

X (mantissa) of input A = 5.0000

Y (exponent) of input A = -1

Refer to 4-2 Setting Mode.



REFERENCE

Hold Measured Value

When the HOLD input is turned ON, measurement stops and the input measured just before the HOLD input turned ON is held. While the HOLD input is ON, the K3NR holds display output, comparative output, and BCD output.

When the comparative output from the Output Board is connected to the HOLD input terminal, the value measured immediately after the occurrence of an error can be obtained.

Performance Characteristics

Accuracy of measurement	$\pm 0.006\% \text{ rdg} \pm 1 \text{ digit}$ (ambient temperature: $23^{\circ}\text{C} \pm 5^{\circ}\text{C}$)
Measurement range	Sensor with transistor output: 0.5 mHz to 50 kHz Sensor with relay output: 0.5 mHz to 30 Hz
ON/OFF pulse width	Sensor with transistor output: 9 μs min. Sensor with relay output: 15 ms min.

Response time	Output configuration				
	Relay output	Transistor output	BCD and transistor output	Linear and transistor output	Communication and transistor output
Comparative output	200 ms max.				
BCD output	---	---	Refer to page 115.	---	---
Linear output	---	---	---	220 ms max.	---

Available Functions

Available functions in this mode are indicated as “Yes” in the following table.

Menu	Function	Displayed Character	Availability	Reference page
---	Max./Min. value display and reset	---	Yes	103
	Estimated frequency calculation	---	Yes	129
S _U SET (See note 2)	Set value bank no. of set values	S _b RRnP	Yes	50
	HH set value	S _u *.HH		
	H set value	S _u *. H		
	L set value	S _u *. L		
	LL set value	S _u *.LL		
PSEL	Select bank no. of prescale value	P _b RRnP	Yes	54
	Prescaling value of input A X (mantissa) Y (exponent)	P5*.R _X P5*.R _Y	Yes	
	Prescaling value of input B X (mantissa) Y (exponent)	P5*.b _X P5*.b _Y	No	
	Decimal point position	dECP.*	Yes	
SETUP	Operating mode	FUnE	Yes	58
	Input A sensor type	UnA	Yes	60
	Input B sensor type	Unb	No	
	Auto zero time of input A X (mantissa) Y (exponent)	Er _a .R _X Er _a .R _Y	Yes	62
	Auto zero time of input B X (mantissa) Y (exponent)	Er _a .b _X Er _a .b _Y	No	
	Display time unit	tUnE	No	65
	Communications unit no. (See note 1)	Un _a	Yes	67
	Baud rate (See note 1)	bPS	Yes	
	Word length (See note 1)	LEn	Yes	69
	Stop bits (See note 1)	Sb _c t	Yes	
	Parity bits (See note 1)	PrEY	Yes	
oPE	Process time for averaging measured value	RuG	Yes	72
	Startup compensation time	StUnE	Yes	74
	Power failure memory	nEn _a	No	76
	Hysteresis (See note 1)	HYS	Yes	78
	Comparative output pattern (See note 1)	E-oUt	Yes	80
	H linear output range (See note 1)	LSET.H	Yes	83
	L Linear output range (See note 1)	LSET.L	Yes	
Remote/Local programming (See note 1)	r-L	Yes	86	

- Note**
1. The availability of the parameters depends on the type of selected Output Board.
 2. The selected bank number will be displayed where an asterisk (*) appears.

3-2 Absolute Ratio: F_2^2



FUNCTION

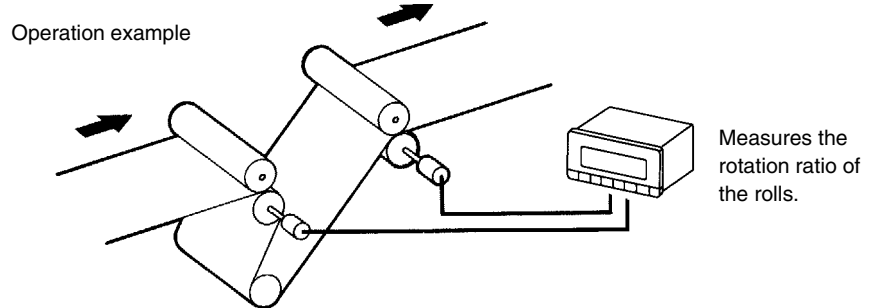

Basic Operation

Displays the absolute ratio of the frequencies of INA and INB in percentage. Obtain display value D as follows:

$$D (\%) = \frac{f_B \times \beta}{f_A \times \alpha} \times 100$$

f_A : Input frequency of INA (Hz)

f_B : Input frequency of INB (Hz)

α : Prescale value of INA

β : Prescale value of INB



SETTING

Mode	Unit of display	Prescale value
Absolute ratio	%	Na and Nb or $\pi da/Na$ and $\pi db/Nb$

Where,

Na: Number of pulses per revolution from A input

Nb: Number of pulses per revolution from B input

πda : Circumference (m) per revolution for A input

πdb : Circumference (m) per revolution for B input

Example:

Displaying absolute revolution rate using two rotary encoders each with 1,000 output pulses per revolution.

Prescale value of INA (α) = $1/1000 = 0.001 = 1.0000 \times 10^{-3}$

Prescale value of INB (β) = $1/1000 = 0.001 = 1.0000 \times 10^{-3}$

Prescale value = $X \times 10^Y$ (X: mantissa, Y: exponent)

X (mantissa) of input A = 1.0000

Y (exponent) of input A = -3

X (mantissa) of input B = 1.0000

Y (exponent) of input B = -3



REFERENCE

Refer to 4-2 Setting Mode.

Hold Measured Value

When the HOLD input is turned ON, measurement stops and the input measured just before the HOLD input turned ON is held. While the HOLD input is ON, the K3NR holds display output, comparative output, and BCD output.

When the comparative output from the Output Board is connected to the HOLD input terminal, the value measured immediately after the occurrence of an error can be obtained.

Performance Characteristics

Accuracy of measurement	$\pm 0.02\%$ rdg ± 1 digit (ambient temperature: $23^\circ\text{C} \pm 5^\circ\text{C}$)
Measurement range	Sensor with transistor output: 0.5 mHz to 50 kHz Sensor with relay output: 0.5 mHz to 30 Hz
ON/OFF pulse width	Sensor with transistor output: 9 μs min. Sensor with relay output: 15 ms min.

Response time	Output configuration				
	Relay output	Transistor output	BCD and transistor output	Linear and transistor output	Communication and transistor output
Comparative output	200 ms max.				
BCD output	---	---	Refer to page 115.	---	---
Linear output	---	---	---	220 ms max.	---

Available Functions

Available functions in this mode are indicated as “Yes” in the following table.

Menu	Function	Displayed Character	Availability	Reference page
---	Max./Min. value display and reset	---	Yes	103
	Estimated frequency calculation	---	Yes	129
S _U SEt (See note 2)	Set value bank no. of set values	S _b Rn ^μ	Yes	50
	HH set value	S _U *.HH		
	H set value	S _U *. H		
	L set value	S _U *. L		
	LL set value	S _U *.LL		
P _S CL	Select bank no. of prescale value	P _b Rn ^μ	Yes	54
	Prescaling value of input A X (mantissa) Y (exponent)	P _S *.R _X P _S *.R _Y	Yes	
	Prescaling value of input B X (mantissa) Y (exponent)	P _S *.b _X P _S *.b _Y	Yes	
	Decimal point position	dECP.*	Yes	
SEtUP	Operating mode	FUnC	Yes	58
	Input A sensor type	LnA	Yes	60
	Input B sensor type	LnB	Yes	
	Auto zero timer of input A X (mantissa) Y (exponent)	Er _a .R _X Er _a .R _Y	Yes	62
	Auto zero timer of input B X (mantissa) Y (exponent)	Er _b .b _X Er _b .b _Y	Yes	
	Display time unit	tLnE	No	65
	Communications unit no. (See note 1)	U-n _o	Yes	67
	Baud rate (See note 1)	bPS	Yes	
	Word length (See note 1)	LEn	Yes	69
	Stop bits (See note 1)	Sb _{it}	Yes	
Parity bits (See note 1)	Pr _{ty}	Yes		
oPt	Process time for averaging measured value	RuG	Yes	72
	Startup compensation time	StLnE	Yes	74
	Power failure memory	nEn _o	No	76
	Hysteresis (See note 1)	HYS	Yes	78
	Comparative output pattern (See note 1)	C-oUt	Yes	80
	H linear output range (See note 1)	LSEt.H	Yes	83
	L linear output range (See note 1)	LSEt.L	Yes	
	Remote/Local programming (See note 1)	r-L	Yes	86

- Note**
1. The availability of the parameters depends on the type of selected Output Board.
 2. The selected bank number will be displayed where an asterisk (*) appears.

3-3 Error Ratio: F3



FUNCTION

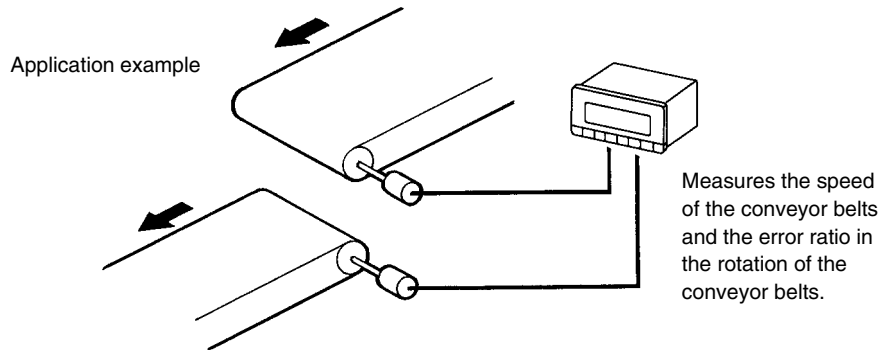

Basic Operation

Displays the error ratio of the frequency of INA and INB in percentage. Obtain display value D as follows:

$$D (\%) = \frac{f_B \times \beta - f_A \times \alpha}{f_A \times \alpha} \times 100$$

f_A: Input frequency of INA (Hz)

f_B: Input frequency of INB (Hz)

α: Prescale value of INA

β: Prescale value of INB



SETTING

Mode	Unit of display	Prescale value
Error ratio	%	Na and Nb or πda/Na and πdb/Nb

Where,

Na: Number of pulses per revolution from A input

Nb: Number of pulses per revolution from B input

πda: Circumference (m) per revolution for A input

πdb: Circumference (m) per revolution for B input

Example:

Displaying error ratio of two conveyor speeds (m/min) using two rotary encoders each with 100 output pulses per revolution and a circumference of 0.125 m.

Prescale value of INA (α) = 0.125/100 = 0.00125 = 1.2500 x 10⁻³

Prescale value of INB (β) = 0.125/100 = 0.00125 = 1.2500 x 10⁻³

Prescale value = X x 10^Y (X: mantissa, Y: exponent)

X (mantissa) of input A = 1.2500

Y (exponent) of input A = -3

X (mantissa) of input B = 1.2500

Y (exponent) of input B = -3



REFERENCE

Refer to 4-2 Setting Mode.

Hold Measured Value

When the HOLD input is turned ON, measurement stops and the input measured just before the HOLD input turned ON is held. While the HOLD input is ON, the K3NR holds display output, comparative output, and BCD output.

When the comparative output from the Output Board is connected to the HOLD input terminal, the value measured immediately after the occurrence of an error can be obtained.

Performance Characteristics

Accuracy of measurement	±0.02% rdg ± 1 digit (ambient temperature: 23°C ± 5°C)
Measurement range	Sensor with transistor output: 0.5 mHz to 50 kHz Sensor with relay output: 0.5 mHz to 30 Hz
ON/OFF pulse width	Sensor with transistor output: 9 μs min. Sensor with relay output: 15 ms min.

Response time	Output configuration				
	Relay output	Transistor output	BCD and transistor output	Linear and transistor output	Communication and transistor output
Comparative output	200 ms max.				
BCD output	---	---	Refer to page 115.	---	---
Linear output	---	---	---	220 ms max.	---

Available Functions

Available functions in this mode are indicated as “Yes” in the following table.

Menu	Function	Displayed Character	Availability	Reference page
---	Max./Min. value display and reset	---	Yes	103
	Estimated frequency calculation	---	Yes	129
S _U SET (See note 2)	Set value bank no. of set values	S _b RRnP	Yes	50
	HH set value	S _u *.HH		
	H set value	S _u *. H		
	L set value	S _u *. L		
	LL set value	S _u *.LL		
PSEL	Select bank no. of prescale value	P _b RRnP	Yes	54
	Prescaling value of input A X (mantissa) Y (exponent)	P5*.R _X P5*.R _Y	Yes	
	Prescaling value of input B X (mantissa) Y (exponent)	P5*.b _X P5*.b _Y	Yes	
	Decimal point position	dECP.*	Yes	
SETUP	Operating mode	FUnE	Yes	58
	Input A sensor type	LnA	Yes	60
	Input B sensor type	LnB	Yes	
	Auto zero time of input A X (mantissa) Y (exponent)	Er _a .R _X Er _a .R _Y	Yes	62
	Auto zero time of input B X (mantissa) Y (exponent)	Er _b .b _X Er _b .b _Y	Yes	
	Display time unit	tLnE	No	65
	Communications unit no. (See note 1)	U-n _a	Yes	67
	Baud rate (See note 1)	bPS	Yes	
	Word length (See note 1)	LEn	Yes	69
	Stop bits (See note 1)	SbLt	Yes	
	Parity bits (See note 1)	PrLY	Yes	
oPE	Process time for averaging measured value	RuG	Yes	72
	Startup compensation time	StLnE	Yes	74
	Power failure memory	nEn _a	No	76
	Hysteresis (See note 1)	HYS	Yes	78
	Comparative output pattern (See note 1)	E-oUt	Yes	80
	H linear output range (See note 1)	LSET.H	Yes	83
	L Linear output range (See note 1)	LSET.L	Yes	
	Remote/Local programming (See note 1)	r-L	Yes	86

- Note**
1. The availability of the parameters depends on the type of selected Output Board.
 2. The selected bank number will be displayed where an asterisk (*) appears.

3-4 Rotational Difference: F4



FUNCTION

Application example

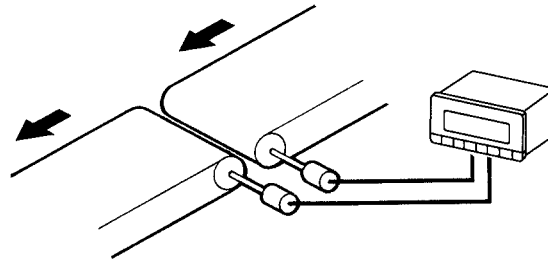

Measures the rotational difference of the conveyor belts.

Basic Operation

Displays the rotational difference of INA and INB. Obtain display value D as follows:

$$D \text{ (rpm)} = f_B \times 60 \times \beta - f_A \times 60 \times \alpha$$

f_A : Input frequency of INA (Hz)

f_B : Input frequency of INB (Hz)

α : Prescale value of INA

β : Prescale value of INB



SETTING

Mode	Unit of display	Prescale value	
Rotational Difference	rpm	INA	1/60Na
		INB	1/60Nb
	Hz (Input pulse frequency)	INA	1/60
		INB	1/60
	mm/sec	INA	1000 π da/60Na
		INB	1000 π db/60Nb
	m/sec	INA	π da/60Na
		INB	π db/60Nb
	m/min	INA	π da/Na
		INB	π db/Nb

Where,

Na: Number of pulses per revolution from A input

Nb: Number of pulses per revolution from B input

π da: Circumference (m) per revolution for A input

π db: Circumference (m) per revolution for B input

Example:

Displaying error in frequency (Hz) using two rotary encoders each with 100 output pulses per revolution.

Prescale value of INA (α) = 1/60 = 0.01666... \doteq 1.6666 x 10⁻²

Prescale value of INB (β) = 1/60 = 0.01666... \doteq 1.6666 x 10⁻²

Prescale value = X x 10^Y (X: mantissa, Y: exponent)

X (mantissa) of input A = 1.6666

Y (exponent) of input A = -2

X (mantissa) of input B = 1.6666

Y (exponent) of input B = -2



REFERENCE

Refer to 4-2 Setting Mode.

Hold Measured Value

When the HOLD input is turned ON, measurement stops and the input measured just before the HOLD input turned ON is held. While the HOLD input is ON, the K3NR holds display output, comparative output, and BCD output.

When the comparative output from the Output Board is connected to the HOLD input terminal, the value measured immediately after the occurrence of an error can be obtained.

Performance Characteristics

Accuracy of measurement	$\pm 0.02\%$ rdg ± 1 digit (ambient temperature: $23^{\circ}\text{C} \pm 5^{\circ}\text{C}$)
Measurement range	Sensor with transistor output: 0.5 mHz to 50 kHz Sensor with relay output: 0.5 mHz to 30 Hz
ON/OFF pulse width	Sensor with transistor output: 9 μs min. Sensor with relay output: 15 ms min.

Response time	Output configuration				
	Relay output	Transistor output	BCD and transistor output	Linear and transistor output	Communication and transistor output
Comparative output	200 ms max.				
BCD output	---	---	Refer to page 115.	---	---
Linear output	---	---	---	220 ms max.	---

Available Functions Available functions in this mode are indicated as “Yes” in the following table.

Menu	Function	Displayed Character	Availability	Reference page
---	Max./Min. value display and reset	---	Yes	103
	Estimated frequency calculation	---	Yes	129
S _U SET (See note 2)	Set value bank no. of set values	S.bRnP	Yes	50
	HH set value	S _U *.HH		
	H set value	S _U *. H		
	L set value	S _U *. L		
	LL set value	S _U *.LL		
PSEL	Select bank no. of prescale value	P.bRnP	Yes	54
	Prescaling value of input A X (mantissa) Y (exponent)	PS*.R _X PS*.R _Y	Yes	
	Prescaling value of input B X (mantissa) Y (exponent)	PS*.b _X PS*.b _Y	Yes	
	Decimal point position	dECP.*	Yes	
SETUP	Operating mode	FUnE	Yes	58
	Input A sensor type	UnA	Yes	60
	Input B sensor type	UnB	Yes	
	Auto zero time of input A X (mantissa) Y (exponent)	Er _a .R _X Er _a .R _Y	Yes	62
	Auto zero time of input B X (mantissa) Y (exponent)	Er _b .b _X Er _b .b _Y	Yes	
	Display time unit	tUnE	No	65
	Communications unit no. (See note 1)	Un _n	Yes	67
	Baud rate (See note 1)	bPS	Yes	
	Word length (See note 1)	LEn	Yes	69
	Stop bits (See note 1)	Sb _{ct}	Yes	
	Parity bits (See note 1)	Pr _{ty}	Yes	
aPE	Process time for averaging measured value	RuG	Yes	72
	Startup compensation time	St _{cnE}	Yes	74
	Power failure memory	nEn _a	No	76
	Hysteresis (See note 1)	HYS	Yes	78
	Comparative output pattern (See note 1)	E- _{oUt}	Yes	80
	H linear output range (See note 1)	LSET.H	Yes	83
	L Linear output range (See note 1)	LSET.L	Yes	
	Remote/Local programming (See note 1)	r-L	Yes	86

- Note**
1. The availability of the parameters depends on the type of selected Output Board.
 2. The selected bank number will be displayed where an asterisk (*) appears.

3-5 Flow Rate Ratio: F5

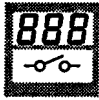

FUNCTION

Application example

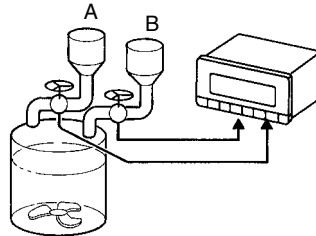

Measures the flow rate ratio of the mixture of A and B.

Basic Operation

From the frequency of INA and INB, displays the flow rate ratio of INB in percentage. Obtain display value D as follows:

$$D (\%) = \frac{f_B \times \beta}{f_A \times \alpha + f_B \times \beta} \times 100$$

f_A : Input frequency of INA (Hz)

f_B : Input frequency of INB (Hz)

α : Prescale value of INA

β : Prescale value of INB



SETTING

Mode	Unit of display	Prescale value	
		INA	Na
		INB	Nb

Where,

Na: Number of pulses for specific quantity of A input

Nb: Number of pulses for specific quantity of B input

Example:

Displaying mixed liquid concentration calculated from the flow rate ratio of two flow sensors each with a capacity of 10 ℓ/400 rpm.

Prescale value of INA (α) = 10/400 = 0.025 = 2.5000 x 10⁻²

Prescale value of INB (β) = 10/400 = 0.025 = 2.5000 x 10⁻²

Prescale value = X x 10^Y (X: mantissa, Y: exponent)

X (mantissa) of input A = 2.5000

Y (exponent) of input A = -2

X (mantissa) of input B = 2.5000

Y (exponent) of input B = -2



REFERENCE

Refer to 4-2 Setting Mode.

Hold Measured Value

When the HOLD input is turned ON, measurement stops and the input measured just before the HOLD input turned ON is held. While the HOLD input is ON, the K3NR holds display output, comparative output, and BCD output.

When the comparative output from the Output Board is connected to the HOLD input terminal, the value measured immediately after the occurrence of an error can be obtained.

Performance Characteristics

Accuracy of measurement	±0.02% rdg ± 1 digit (ambient temperature: 23°C ± 5°C)
Measurement range	Sensor with transistor output: 0.5 mHz to 50 kHz Sensor with relay output: 0.5 mHz to 30 Hz
ON/OFF pulse width	Sensor with transistor output: 9 μs min. Sensor with relay output: 15 ms min.

Response time	Output configuration				
	Relay output	Transistor output	BCD and transistor output	Linear and transistor output	Communication and transistor output
Comparative output	200 ms max.				
BCD output	---	---	Refer to page 115.	---	---
Linear output	---	---	---	220 ms max.	---

Available Functions

Available functions in this mode are indicated as “Yes” in the following table.

Menu	Function	Displayed Character	Availability	Reference page
---	Max./Min. value display and reset	---	Yes	103
	Estimated frequency calculation	---	Yes	129
S ₀ SET (See note 2)	Set value bank no. of set values	S ₀ BRnP	Yes	50
	HH set value	S ₀ *.HH		
	H set value	S ₀ *. H		
	L set value	S ₀ *. L		
	LL set value	S ₀ *.LL		
PSEL	Select bank no. of prescale value	P.bRnP	Yes	54
	Prescaling value of input A X (mantissa) Y (exponent)	PS*.R _X PS*.R _Y	Yes	
	Prescaling value of input B X (mantissa) Y (exponent)	PS*.b _X PS*.b _Y	Yes	
	Decimal point position	dECP.*	Yes	
SETUP	Operating mode	FUnE	Yes	58
	Input A sensor type	UnA	Yes	60
	Input B sensor type	Unb	No	
	Auto zero time of input A X (mantissa) Y (exponent)	Er ₀ .R _X Er ₀ .R _Y	Yes	62
	Auto zero time of input B X (mantissa) Y (exponent)	Er ₀ .b _X Er ₀ .b _Y	Yes	
	Display time unit	tUnE	No	65
	Communications unit no. (See note 1)	Un ₀	Yes	67
	Baud rate (See note 1)	bPS	Yes	
	Word length (See note 1)	LEn	Yes	69
	Stop bits (See note 1)	Sb ₀ t	Yes	
	Parity bits (See note 1)	Pr ₀ tY	Yes	
aPE	Process time for averaging measured value	RuG	Yes	72
	Startup compensation time	StUnE	Yes	74
	Power failure memory	nEn ₀	No	76
	Hysteresis (See note 1)	HYS	Yes	78
	Comparative output pattern (See note 1)	E-aUt	Yes	80
	H linear output range (See note 1)	LSET.H	Yes	83
	L Linear output range (See note 1)	LSET.L	Yes	
	Remote/Local programming (See note 1)	r-L	Yes	86

- Note**
1. The availability of the parameters depends on the type of selected Output Board.
 2. The selected bank number will be displayed where an asterisk (*) appears.

3-6 Passing Time: FE



FUNCTION

Application example

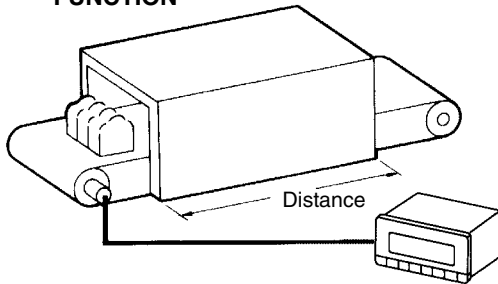

Measures the passing time for a conveyor line.

Basic Operation

Measures and displays the input pulse frequency of INA in units of seconds. By selecting an appropriate prescale value, object passing time D in the range determined by the prescale value will be displayed. Obtain display value D as follows:

$$D \text{ (sec)} = 1/f_A \times \alpha$$

f_A : INA input frequency (Hz)
 α : prescale value of INA

Rotational speed = Input frequency (f) x (1/No. of pulses (N) per 1 cycle)
 Circumferential speed = Circumference of roll (πd) x rotational speed
 Passing time = Processing length (L)/Circumferential speed

INB input will be ignored.

Passing time is measured in this mode. Therefore, if the K3NR does not receive any pulses for a certain period, the K3NR estimates passing time using the estimated frequency calculation function and increases the displayed value.



SETTING

Mode	Unit of display value	Prescale value
Passing time	sec	$L/(\pi d/N)$

N = No. of pulses per 1 cycle from input A
 πd = Circumferential length (m) per 1 cycle
 L = Processing length (m)

Note The K3NR can display the hour, minute, and second. Refer to page 65 for details.

Example:

Displaying passing time (sec) using a rotary encoder with 100 output pulses per revolution.

Circumference of rotary encoder = 0.125 m

Process length = 5 m

Prescaling value (α) = $5/(0.125/100) = 4000 = 4.000 \times 10^3$

Prescale value = $X \times 10^Y$ (X: mantissa, Y: exponent)

X (mantissa) of input A = 4.000

Y (exponent) of input A = 3

Refer to 4-2 Setting Mode.



REFERENCE

Hold Measured Value

When the HOLD input is turned ON, measurement stops and the input measured just before the HOLD input turned ON is held. While the HOLD input is ON, the K3NR holds display output, comparative output, and BCD output.

When the comparative output from the Output Board is connected to the HOLD input terminal, the value measured immediately after the occurrence of an error can be obtained.

Performance Characteristics

Accuracy of measurement	$\pm 0.006\% \text{ rdg} \pm 1 \text{ digit}$ (ambient temperature: $23^{\circ}\text{C} \pm 5^{\circ}\text{C}$)
Measurement range	Sensor with transistor output: 0.5 mHz to 50 KHz Sensor with relay output: 0.5 mHz to 30 Hz
ON/OFF pulse width	Sensor with transistor output: 9 μs min. Sensor with relay output: 15 ms min.

Response time	Output configuration				
	Relay output	Transistor output	BCD and transistor output	Linear and transistor output	Communication and transistor output
Comparative output	200 ms max.				
BCD output	---	---	Refer to page 115.	---	---
Linear output	---	---	---	220 ms max.	---

Available Functions

Available functions in this mode are indicated as “Yes” in the following table.

Menu	Function	Displayed Character	Availability	Reference page
---	Max./Min. value display and reset	---	Yes	103
	Estimated frequency calculation	---	Yes	129
<i>S₀SET</i> (See note 2)	Set value bank no. of set values	<i>S₀BRnP</i>	Yes	50
	HH set value	<i>S₀*.HH</i>		
	H set value	<i>S₀*. H</i>		
	L set value	<i>S₀*. L</i>		
	LL set value	<i>S₀*.LL</i>		
<i>PSEL</i>	Select bank no. of prescale value	<i>P.bRnP</i>	Yes	54
	Prescaling value of input A X (mantissa) Y (exponent)	<i>P5*.R_X</i> <i>P5*.R_Y</i>	Yes	
	Prescaling value of input B X (mantissa) Y (exponent)	<i>P5*.b_X</i> <i>P5*.b_Y</i>	No	
	Decimal point position	<i>dECP.*</i>	Yes	
<i>SETUP</i>	Operating mode	<i>FUnE</i>	Yes	58
	Input A sensor type	<i>UnA</i>	Yes	60
	Input B sensor type	<i>Unb</i>	No	
	Auto zero time of input A X (mantissa) Y (exponent)	<i>Er₀.R_X</i> <i>Er₀.R_Y</i>	Yes	62
	Auto zero time of input B X (mantissa) Y (exponent)	<i>Er₀.b_X</i> <i>Er₀.b_Y</i>	No	
	Display time unit	<i>tUnE</i>	No	65
	Communications unit no. (See note 1)	<i>Un₀</i>	Yes	67
	Baud rate (See note 1)	<i>bPS</i>	Yes	
	Word length (See note 1)	<i>LEn</i>	Yes	69
	Stop bits (See note 1)	<i>Sb₀t</i>	Yes	
	Parity bits (See note 1)	<i>Pr₀tY</i>	Yes	
<i>oPE</i>	Process time for averaging measured value	<i>RuG</i>	Yes	72
	Startup compensation time	<i>StUnE</i>	Yes	74
	Power failure memory	<i>nEn₀</i>	No	76
	Hysteresis (See note 1)	<i>HYS</i>	Yes	78
	Comparative output pattern (See note 1)	<i>E-oUt</i>	Yes	80
	H linear output range (See note 1)	<i>LSET.H</i>	Yes	83
	L Linear output range (See note 1)	<i>LSET.L</i>	Yes	
	Remote/Local programming (See note 1)	<i>r-L</i>	Yes	86

- Note**
1. The availability of the parameters depends on the type of selected Output Board.
 2. The selected bank number will be displayed where an asterisk (*) appears.

3-7 Pulse Counting: F7



FUNCTION

Application example

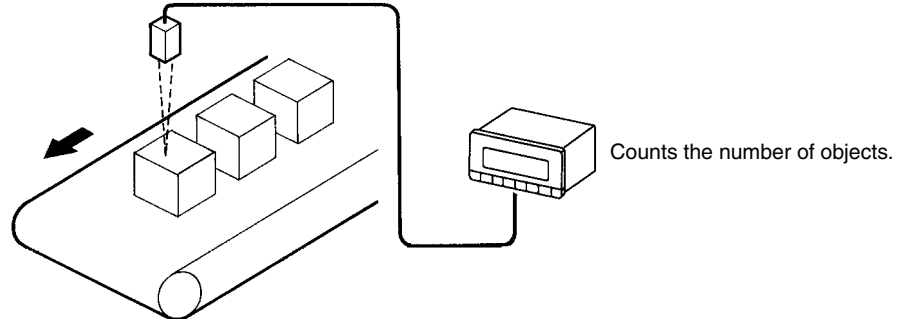
**Basic Operation**

Counts the number of pulses of INA and displays the result. Obtain display value D as follows:

$$D \text{ (pulse count)} = C \times \alpha$$

C: Pulse count of INA

α : Prescale value

Hold Displayed Value

By turning the HOLD input ON, the displayed value can be put on HOLD. While the HOLD input is ON, the pulse counting operation continues, as does comparative output and BCD output. In this case, using the HOLD input is similar to checking a lap time with a stopwatch.

Interruption of Pulse Counting

With INB input ON, the pulse counting operation is interrupted and the measured value, comparative outputs, and BCD output are on HOLD. Pulse counting will not begin while INB input is ON.

Clearing Accumulated Value

When the RESET input turns ON, the accumulated value is cleared to zero. Pulse counting will not start while the RESET input is ON.

The accumulated value will be stored or cleared to zero when the K3NR is turned off, and depends on the setting of the power failure memory (\overline{PFM}) at option menu.

Note By connecting comparative output with the RESET input terminal, the K3NR can be used as a single-mode preset counter.

Comparative Output

With operating mode 7, comparative output L, LL, H, or HH turns ON when the measured value exceeds the set value. Refer to following chart for details.

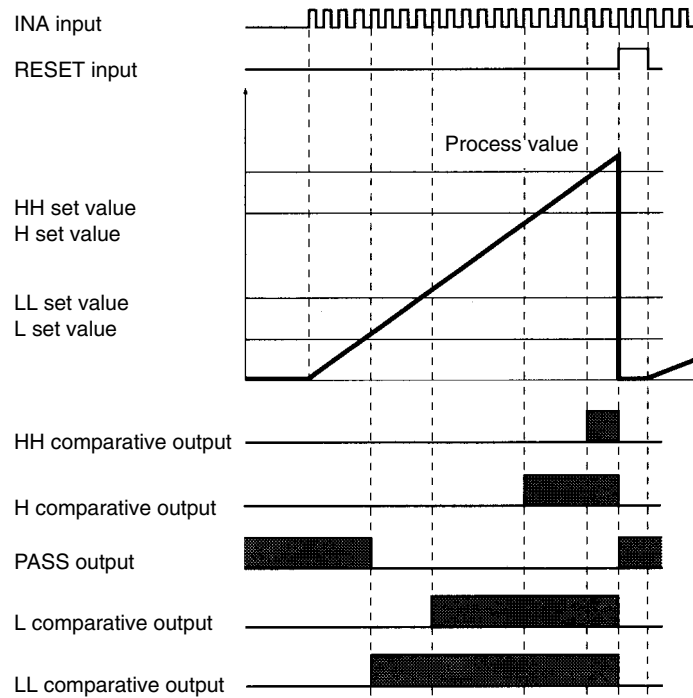

SETTING

Mode	Unit of display value	Prescale value
1 pulse = n counts	Count	n
n pulses = 1 count	Count	1/n

Example:

Counting four pulses as a single unit to be displayed.

Prescaling value (α) = $1/4 = 0.25 = 0.25 \times 10^0$

Prescale value = $X \times 10^Y$ (X: mantissa, Y: exponent)

X (mantissa) of input A = 0.25

Y (exponent) of input A = 0



REFERENCE

4-2 Setting Mode.

Performance Characteristics

Maximum counting speed	Sensor with transistor output: 50 kcps Sensor with relay output: 30 cps
Counting range	0 to 4 G (with 32-bit counter)
Response time of HOLD or RESET input	20 ms max.
ON/OFF pulse width	Sensor with transistor output: 9 μ s min. Sensor with relay output: 15 ms min.

Response time	Output configuration				
	Relay output	Transistor output	BCD and transistor output	Linear and transistor output	Communication and transistor output
Comparative output	10 ms max.	1 ms max.	20 ms max.	20 ms max.	1 ms max.
BCD output	---	---	Refer to page 115.	---	---
Linear output	---	---	---	20 ms max.	---

Maximum Pulse Counting Speed

Maximum pulse counting speed is the maximum speed at which the K3NR can count INA input pulses accurately. If comparative output is used as control output, the maximum pulse counting speed can be obtained as follows:

$$\text{Maximum counting speed (cps)} = 1/\text{Delay in comparative outputs (sec)}$$

If comparative output is directly connected to RESET input, the maximum pulse counting speed can be obtained as follows:

$$\text{Maximum counting speed (cps)} = 1/\text{Delay in comparative outputs (sec)} + \text{Response time of RESET input (sec)}$$

Response Time of HOLD or RESET Input

The response time of the HOLD or RESET input is the time required for the K3TR to accept HOLD or RESET input after the HOLD or RESET input turns ON. This is illustrated in the following diagram.

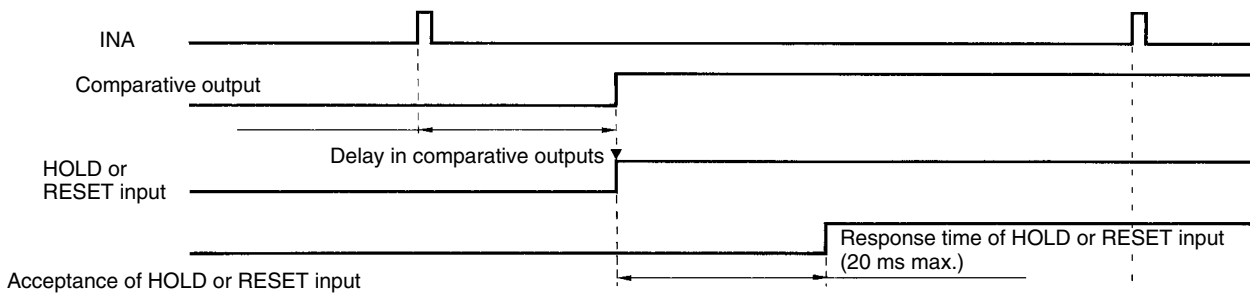

Available Functions

Available functions in this mode are indicated as “Yes” in the following table.

Menu	Function	Displayed Character	Availability	Reference page
---	Max./Min. value display and reset	---	Yes	103
	Estimated frequency calculation	---	No	129
S _U SET (See note 2)	Set value bank no. of set values	S _b RRnP	Yes	50
	HH set value	S _U *.HH		
	H set value	S _U *. H		
	L set value	S _U *. L		
	LL set value	S _U *.LL		
PSEL	Select bank no. of prescale value	P _b RRnP	Yes	54
	Prescaling value of input A X (mantissa) Y (exponent)	P5*.R _X P5*.R _Y	Yes	
	Prescaling value of input B X (mantissa) Y (exponent)	P5*.b _X P5*.b _Y	No	
	Decimal point position	dECP.*	Yes	
SETUP	Operating mode	FUnE	Yes	58
	Input A sensor type	UnA	Yes	60
	Input B sensor type	UnB	Yes	
	Auto zero time of input A X (mantissa) Y (exponent)	Er _a .R _X Er _a .R _Y	No	62
	Auto zero time of input B X (mantissa) Y (exponent)	Er _b .b _X Er _b .b _Y	No	
	Display time unit	tUnE	No	65
	Communications unit no. (See note 1)	Un _n	Yes	67
	Baud rate (See note 1)	bPS	Yes	
	Word length (See note 1)	LEn	Yes	69
	Stop bits (See note 1)	Sb _{ct}	Yes	
	Parity bits (See note 1)	Pr _{ty}	Yes	
oPE	Process time for averaging measured value	R _{uG}	No	72
	Startup compensation time	St _{cnE}	No	74
	Power failure memory	nEn _a	Yes	76
	Hysteresis (See note 1)	HYS	No	78
	Comparative output pattern (See note 1)	E- _{oU} t	No	80
	H linear output range (See note 1)	LSET.H	Yes	83
	L Linear output range (See note 1)	LSET.L	Yes	
	Remote/Local programming (See note 1)	r-L	Yes	86

- Note**
1. The availability of the parameters depends on the type of selected Output Board.
 2. The selected bank number will be displayed where an asterisk (*) appears.

SECTION 4

Parameter Setting

This section provides instructions for setting the parameters of the K3NR. Be sure to read this section before using the K3NR Frequency/Rate Meter for the first time.

4-1	Overview	46
4-1-1	Heading Symbols	46
4-1-2	Setting Procedures	46
4-2	Setting Mode	47
4-2-1	Selecting Setting Mode	47
4-2-2	Menu Overview	48
4-2-3	Setting Value Menu (<i>5u5Et</i>)	50
	Bank No. of Set Value	50
	HH Set Value	50
	H Set Value	50
	L Set Value	50
	LL Set Value	50
4-2-4	Prescaling Menu (<i>P5LL</i>)	54
	Bank No. of Prescale	54
	Prescaling Value X (Mantissa) of Input A	54
	Prescaling Value Y (Exponent) of Input A	54
	Prescaling Value X (Mantissa) of Input B	54
	Prescaling Value Y (Exponent) of Input B	54
	Decimal Point Position	54
4-2-5	Setup Menu (setup)	58
	Operating Mode	58
	Sensor Type	60
	Auto Zero Time of Input A X (Mantissa)	62
	Auto Zero Time of Input A Y (Exponent)	62
	Auto Zero Time of Input B X (Mantissa)	62
	Auto Zero Time of Input B Y (Exponent)	62
	Time Unit	65
	Communications Unit Number	67
	Baud Rate	67
	Word Length	69
	Stop Bits	69
	Parity Bits	69
4-2-6	Option Menu (<i>OPt</i>)	72
	Process Time for Averaging Measured Value	72
	Startup Compensation Time	74
	Power Failure Memory	76
	Hysteresis	78
	Comparative Output Pattern	80
	Upper Limit (H) of Linear Output Range	83
	Lower Limit (L) of Linear Output Range	83
	Remote/Local Programming	86
4-3	Protect Mode	88
4-3-1	Selecting Protect Mode	88
4-3-2	Menu Overview	89
4-3-3	Protect Menu (<i>PrOt</i>)	90
	All Key Protect	90
	Setting Value Change Prohibit	91
	Counting Value Reset Prohibit	93
	Maximum/Minimum Value Clear Prohibit	95
	Security	97

4-1 Overview

4-1-1 Heading Symbols

The following symbols are used for headings in this section.

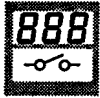

FUNCTION

This symbol precedes an explanation of the parameter's meaning and function.



SETTING

This symbol precedes a description of the settings, setting range, and default value.

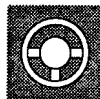

PROCEDURE

This symbol precedes an explanation of procedures for parameters that specify operations.

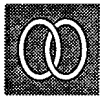

REFERENCE

This symbol precedes a listing of references and related parameters.



MODELS

This symbol precedes a listing of the models in which this parameter can be used.

4-1-2 Setting Procedures

- The K3NR has four modes: RUN mode for normal operations, Setting mode for initial parameter input, Protect mode for lock-out configuration, and Maintenance mode for initializing set values. The parameters that are accessible on any individual K3NR will vary depending on the Output Board installed. Refer to *Appendix D Available Parameters*.

- The K3NR is in RUN mode when the K3NR is turned on. Parameter settings in protect or setting mode are described below on the basis that the parameters are set for the first time.

For the operation in RUN mode, refer to *Section 5 Operations in RUN Mode*.

- The setting examples are provided on condition that the factory-set values of the K3NR have not been changed.

4-2 Setting Mode

4-2-1 Selecting Setting Mode

- The K3NR in RUN mode will go into setting mode if the Mode Key is pressed for 1 s minimum.
- The K3NR in setting mode will go into RUN mode if the Escape Key is pressed.

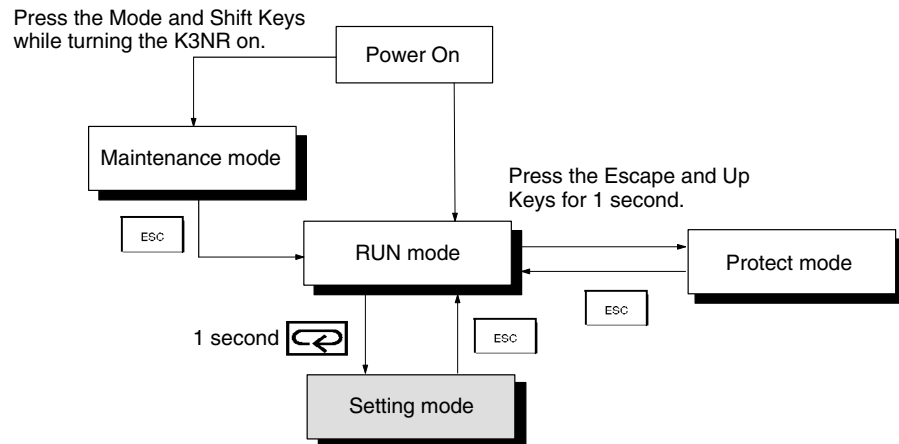

- The menu in each mode changes whenever the Mode Key is pressed.
- If the Mode Key is pressed for more than one second while a menu is displayed, a parameter will be displayed.
- The parameter changes whenever the Mode Key is pressed.
- If the Shift Key is pressed while a parameter is displayed, the parameter will be ready to change.
- Press the Up Key to change parameters.
- The digit of a set value is selected with the Shift Key and changed with the Up Key.
- The PROG indicator is lit while a menu or parameter is displayed.
- The PROG indicator flashes during a set value change.

Note If the operating mode is changed, all the other parameters will be set to default values except communication setting and set values in protect mode. Therefore, set the operating mode and sensor type first.

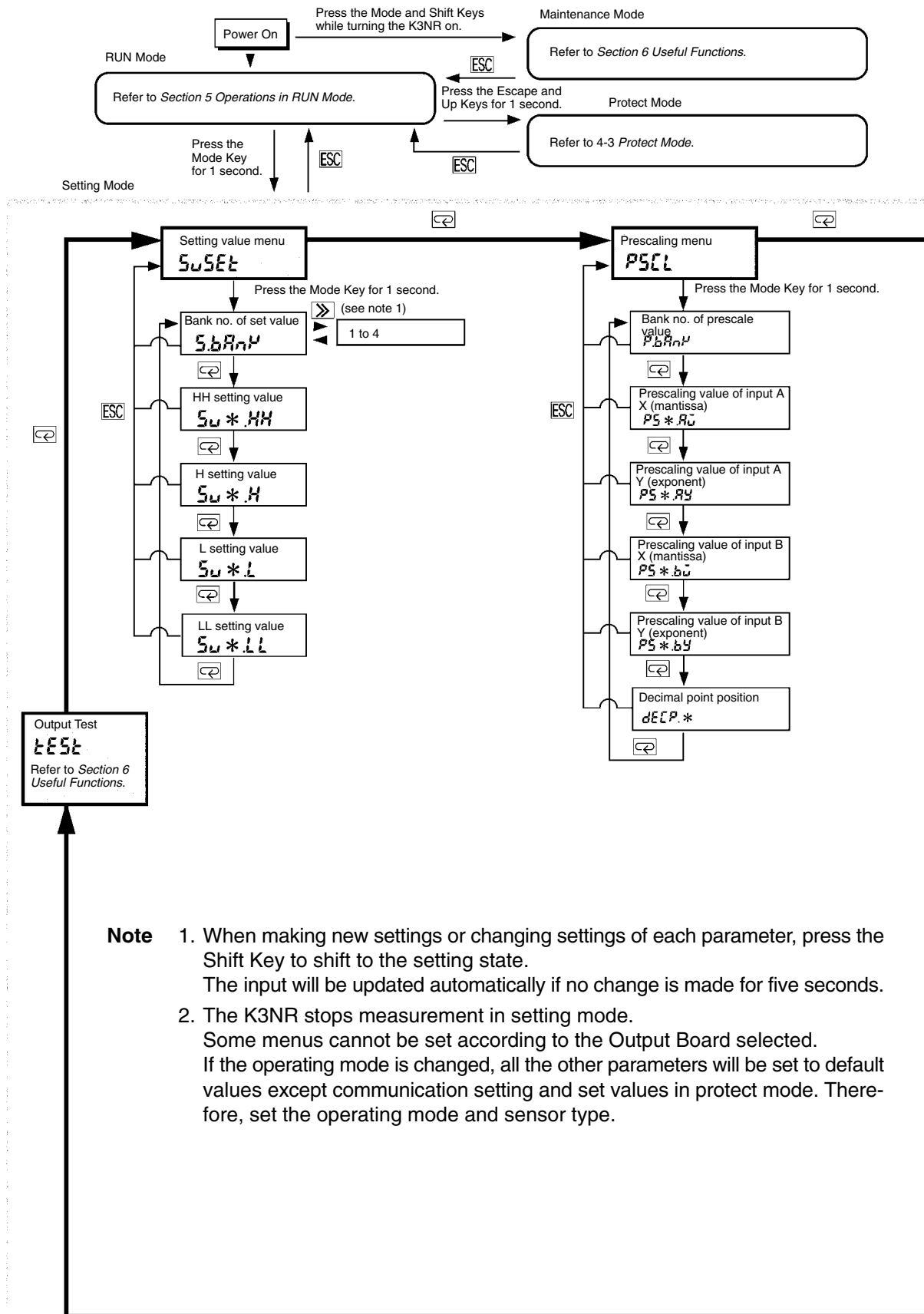

4-2-2 Menu Overview

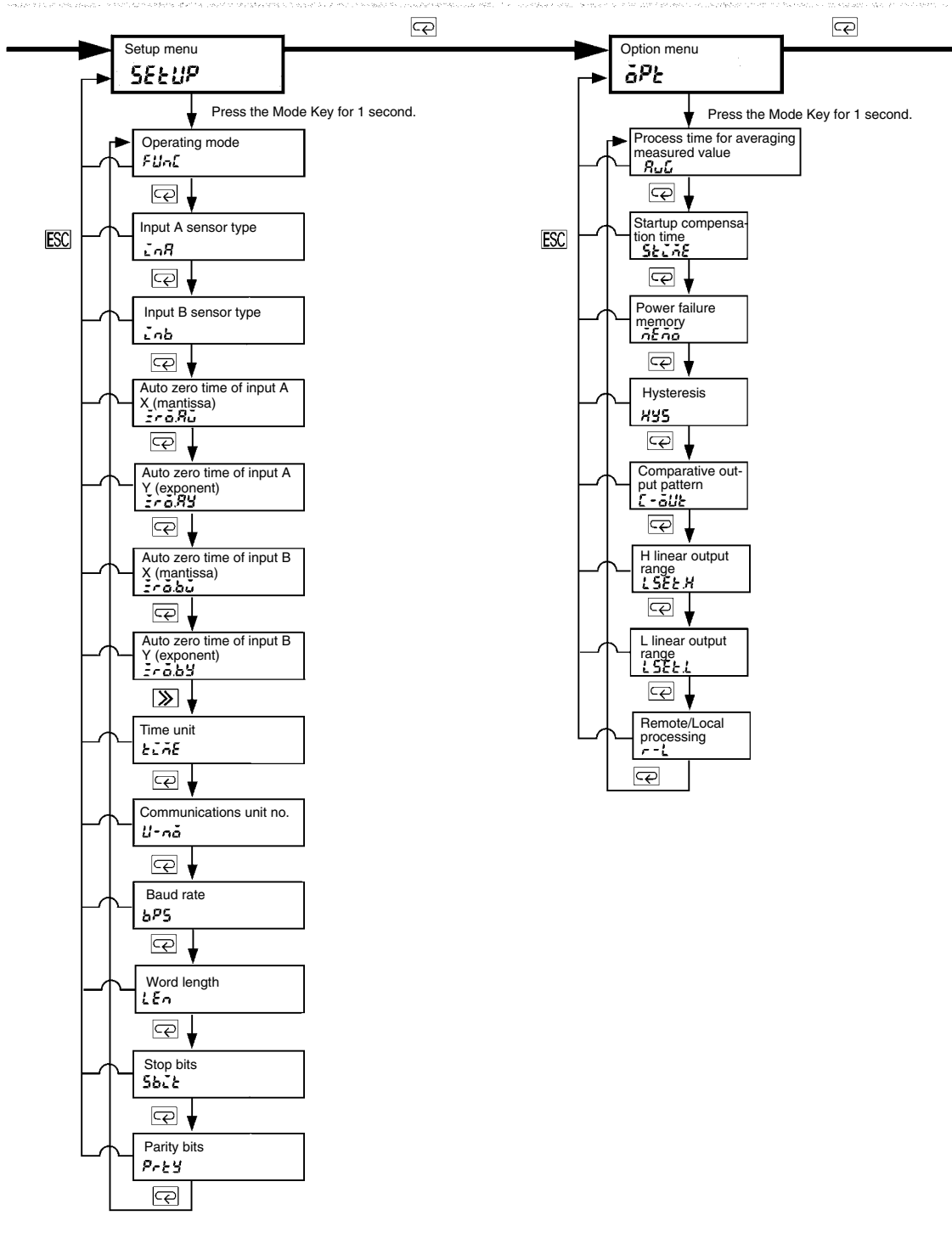

- Note**
1. When making new settings or changing settings of each parameter, press the Shift Key to shift to the setting state.
The input will be updated automatically if no change is made for five seconds.
 2. The K3NR stops measurement in setting mode.
Some menus cannot be set according to the Output Board selected.
If the operating mode is changed, all the other parameters will be set to default values except communication setting and set values in protect mode. Therefore, set the operating mode and sensor type.

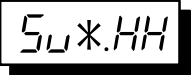
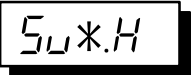

4-2-3 Setting Value Menu (5uSET)

	Bank No. of Set Value
	HH Set Value
	H Set Value
	L Set Value
	LL Set Value



FUNCTION



SETTING

- There are two basic methods for setting HH, H, L, and LL set values: by entering during RUN mode via the front-panel buttons, setting in Setting mode, or by the teaching function.

Setting	Setting range	Default
Set value bank	1 to 4	1
HH set value	-19,999 to 99999	99,999
H set value		99,999
L set value		-19999
LL set value		-19999

Set the decimal point position in the prescaling menu.

Refer to *6-1 Teaching Function*.



REFERENCE



MODELS

- The menu is only available for the K3NR with Comparative Output Board.

SETTING EXAMPLE

Follow the steps described below to input the following.

- Setting value bank = 2
- HH setting value = "8000"
- H setting value = "6000"
- L setting value = "4000"
- LL setting value = "2000"

Set Value LED Display Model Basic Model

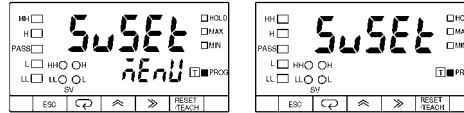

- 1, 2, 3...
1. Press the Mode Key for more than one second while the *SuSEt* setting value menu is displayed. The *S.bAnU* setting value bank setting will be displayed.

Set Value LED Display Model Basic Model

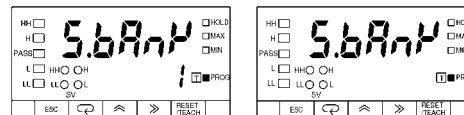

2. Press the Shift Key to display the set value *!* for changing. The PROG indicator will flash.

Set Value LED Display Model Basic Model

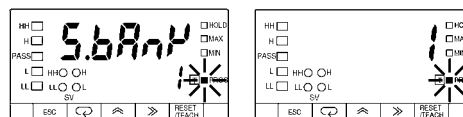

3. Press the Up Key to set the value to *2*. The input will be validated automatically if no change is made for five seconds. The *S.bAnU* setting value bank setting will be displayed again.

Note Press the Mode Key to enter the set value immediately. The *Su2.HH* HH setting value of bank 2 setting will be displayed for setting the next parameter.

Set Value LED Display Model Basic Model

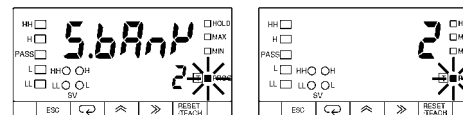

4. Press the Mode Key to display the *Su2.HH* HH setting value of bank 2 setting.

Set Value LED Display Model Basic Model

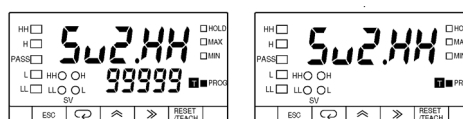

5. Press the Shift Key to display the set value *99999* for changing. The PROG indicator will flash.

Set Value LED Display Model Basic Model

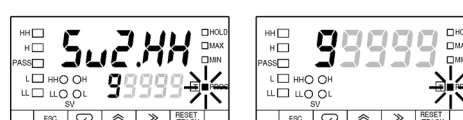

- Press the Up and Shift Keys to set the value to 8000. The input will be validated automatically if no change is made for five seconds. The $S_{u2.HH}$ HH setting value of bank 2 setting will be displayed again.

Note Press the Mode Key to enter the set value immediately. The $S_{u2.H}$ H setting value of bank 2 setting will be displayed for setting the next parameter.

Set Value LED Display Model Basic Model

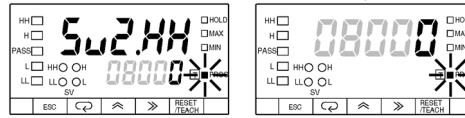

- Press the Mode Key to display the $S_{u2.H}$ H setting value of bank 2 setting.

Set Value LED Display Model Basic Model

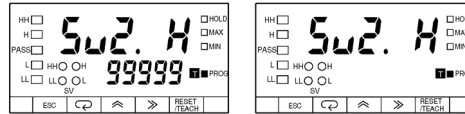

- Press the Shift Key to display the set value 99999 for changing. The PROG indicator will flash.

Set Value LED Display Model Basic Model

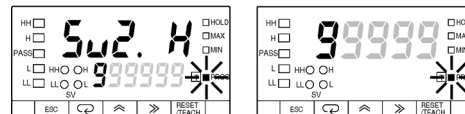

- Press the Up and Shift Keys to set the value to 5000. The input will be validated automatically if no change is made for five seconds. The $S_{u2.H}$ H setting value of bank 2 setting will be displayed again.

Note Press the Mode Key to enter the set value immediately. The $S_{u2.L}$ L setting value of bank 2 setting will be displayed for setting the next parameter.

Set Value LED Display Model Basic Model

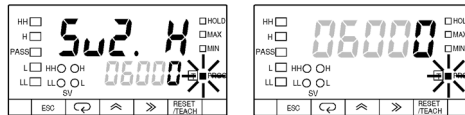

- Press the Mode Key to display the $S_{u2.L}$ L setting value of bank 2 setting.

Set Value LED Display Model Basic Model

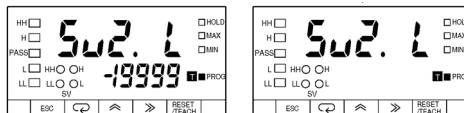

- Press the Shift Key to display the set value -19999 for changing. The PROG indicator will flash.

Set Value LED Display Model Basic Model

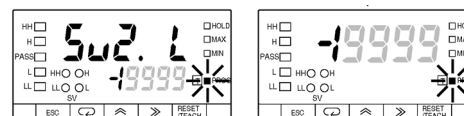

- Press the Up and Shift Keys to set the value to 4000. The input will be validated automatically if no change is made for five seconds. The Sv2.LL setting value of bank 2 setting will be displayed again.

Note Press the Mode Key to enter the input immediately. The Sv2.LL setting value setting will be displayed for setting the next parameter.

Set Value LED Display Model Basic Model

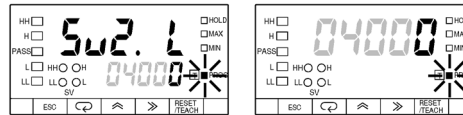

- Press the Mode Key to display the Sv2.LL setting value of bank 2 setting.

Set Value LED Display Model Basic Model

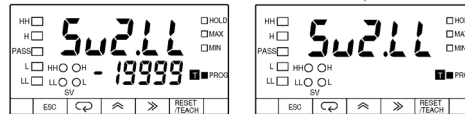

- Press the Mode Key to display the set value -19999 for changing. The PROG indicator will flash.

Set Value LED Display Model Basic Model

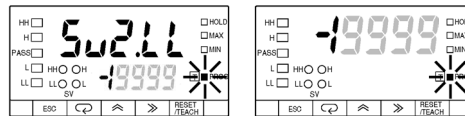

- Press the Up and Shift Keys to set the value to 2000. The input will be validated automatically if no change is made for five seconds. The Sv2.LL setting value setting will be displayed again.

Note Press the Mode Key to enter the set value immediately. The Sv2.LL setting value bank setting will be displayed for setting the next parameter.

Set Value LED Display Model Basic Model

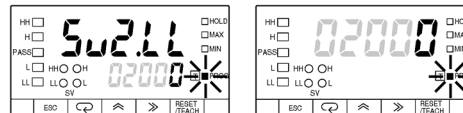

- Press the Escape Key to display the Sv5Et setting value menu.

Set Value LED Display Model Basic Model

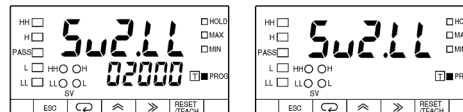

Set Value LED Display Model Basic Model

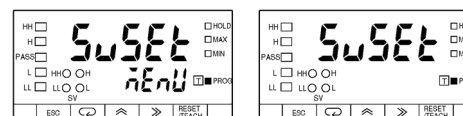

4-2-4 Prescaling Menu (P5CL)

P.bAnP	<u>Bank No. of Prescale</u>
P5*.A \bar{U}	<u>Prescaling Value X (Mantissa) of Input A</u>
P5*.AY	<u>Prescaling Value Y (Exponent) of Input A</u>
P5*.b \bar{U}	<u>Prescaling Value X (Mantissa) of Input B</u>
P5*.bY	<u>Prescaling Value Y (Exponent) of Input B</u>
dECP.*	<u>Decimal Point Position</u>



To display rotational speeds, circumferential speeds, or other values based on input pulse calculations, the rotational speed must be multiplied by a factor input before the input pulses are measured. This factor is called a prescale value.

Display value = Measured data x Prescaling value

Prescaling values can be set within a range between 0.0001×10^{-9} and 9.9999×10^9 .

Example:

Setting prescaling value with the input of two pulses per revolution.

Unit: rpm
Operating Mode: 1

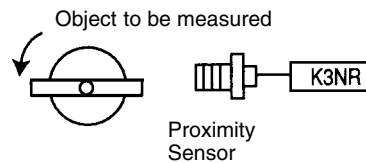

Two pulses are output per revolution. Therefore, the prescaling value is calculated: $0.5 \times 10^0 = 5.0 \times 10^{-1}$

P.bAnP = OFF
P5.A \bar{U} = 5.0000
P5.AY = 10 - 1

Note Use prescaling banks 1 through four if more than one prescaling value needs to be set.



Input type	Setting	Default
P.bAnP: Bank no. of prescale	OFF/1 to 4	OFF
P5*.A \bar{U} : Prescaling value X (mantissa) of input A	0.0001 to 9.9999	1.0000
P5*.AY: Prescaling value Y (exponent) of input A	-9 to 9	0
P5*.b \bar{U} : Prescaling value X (mantissa) of input B	0.0001 to 9.9999	1.0000
P5*.bY: Prescaling value Y (exponent) of input B	-9 to 9	0
dECP.*: Decimal point position	Operating modes 3 and 4: One of the 1st to 3rd digits from the right Other modes: One of the 1st to 4th digits from the right	No decimal point position setting

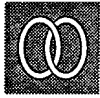

REFERENCE

Refer to 6-1 Teaching Function.

SETTING EXAMPLE

Follow the steps described below to input the following.

- Operating mode = F1
- Prescaling bank = OFF
- Prescaling value X (mantissa) of input A = 0.5000
- Prescaling value Y (exponent) of input A = -1
- Decimal point = □□□□.□ (1st digit from the right)

Set Value LED Display Model Basic Model

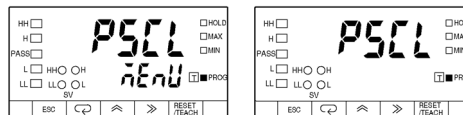

- 1, 2, 3...
1. Press the Mode Key for more than one second while the *PSCL* prescaling menu is displayed. The *P.bAnU* prescaling bank setting will be displayed.

Set Value LED Display Model Basic Model

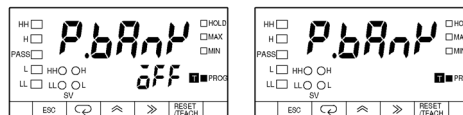

2. Press the Shift Key to display *oFF* for changing. The PROG indicator will flash.

Set Value LED Display Model Basic Model

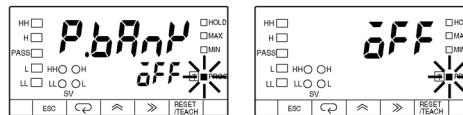

3. Press the Up Key to change the prescaling bank setting. The input will be validated automatically if no change is made for five seconds. The *P.bAnU* prescaling bank setting will be displayed again.

Note Press the Mode Key to enter the set value immediately. The *PS.AU* prescaling value X (mantissa) of input A setting will be displayed for setting the next parameter.

Set Value LED Display Model Basic Model

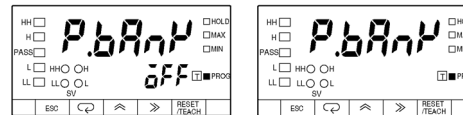

4. Press the Mode Key to display the *PS.AU* prescaling value X (mantissa) of input A setting.

Set Value LED Display Model Basic Model

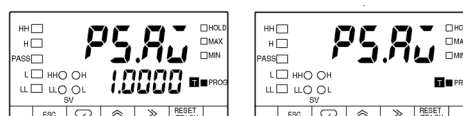

- Press the Shift Key to display the set value 1.0000 for changing. The PROG indicator will flash.

Set Value LED Display Model Basic Model

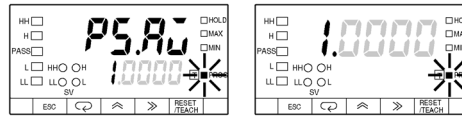

- Press the Up and Shift Keys to set the value to 0.5000 . The input will be validated automatically if no change is made for five seconds. The $P5.A$ prescaling value X (mantissa) of input A setting will be displayed again.

Note Press the Mode Key to enter the set value immediately. The $P5.A$ prescaling value X (mantissa) of input A setting will be displayed for setting the next parameter.

Set Value LED Display Model Basic Model

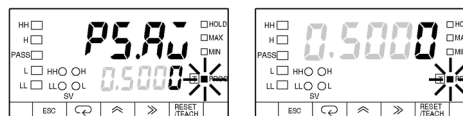

- Press the Mode Key to display the $P5.AY$ prescaling value Y (exponent) of input A setting.

Set Value LED Display Model Basic Model

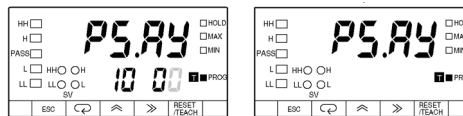

- Press the Shift Key to display the set value $10 - 1$ for changing.

Set Value LED Display Model Basic Model

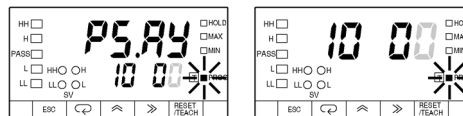

- Press the Up and Shift Keys to set the value to $10 - 1$. The input will be validated automatically if no change is made for five seconds. The $P5.AY$ prescaling value Y (exponent) of input A setting will be displayed again.

- Note**
- Press the Mode Key to enter the set value immediately. The $dECP$ decimal point position setting will be displayed again.
 - If the set operating mode is F2 through F5, the $P5.b$ prescaling value X (mantissa) of input B setting will be displayed.

Set Value LED Display Model Basic Model

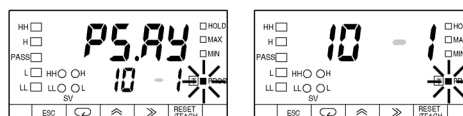

10. Press the Mode Key to display the *dECP* decimal point position setting.

Note If the set operating mode is F2 through F5, the *PS.bū* prescaling value X (mantissa) of input B setting will be displayed.

Set Value LED Display Model Basic Model

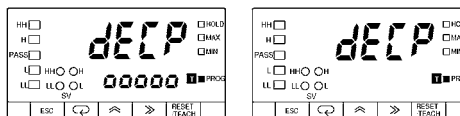

11. Press the Shift Key to display *00000* for changing.

Set Value LED Display Model Basic Model

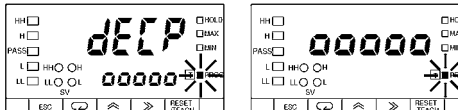

12. Press the Shift Key to set *0000.0*. The input will be validated automatically if no change is made for five seconds. The *dECP* decimal point position setting will be displayed again.

Note Press the Mode Key to enter the set value immediately. The *P.bPnū* prescaling bank setting will be displayed for setting the next parameter.

Set Value LED Display Model Basic Model

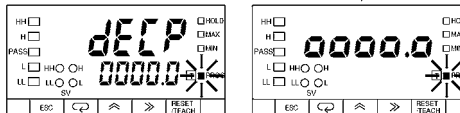

13. Press the Escape Key to display the *PSCL* prescaling menu.

Set Value LED Display Model Basic Model

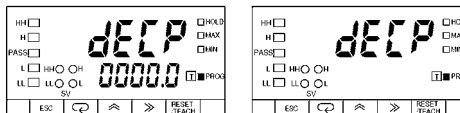

Set Value LED Display Model Basic Model

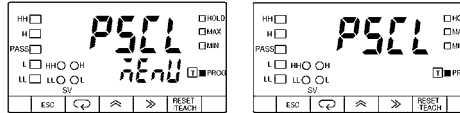

4-2-5 Setup Menu (SETUP)



Operating Mode



FUNCTION

Use this menu to select the operating mode of the K3NR. All parameters will be set to default values if any change is made in this parameter except to those for the communications and protect settings.

- F1*: Displays the number of circumferential or rotational speed of input A.
- F2* through *F5*: Displays the result of the arithmetic operation of two different revolutions.
- F6*: Displays the value of passing time calculated from the frequency or processing length of input A.
- F7*: Displays the pulse counting of input A.



SETTING

Setting	Default
<i>F1</i> : Rotational/circumferential speed	<i>F1</i>
<i>F2</i> : Absolute ratio	
<i>F3</i> : Error ratio	
<i>F4</i> : Rotational difference	
<i>F5</i> : Flow rate ratio	
<i>F6</i> : Passing time	
<i>F7</i> : Pulse counting	

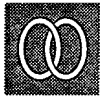

REFERENCE

Refer to *Section 3 Operating Modes*.

SETTING EXAMPLE

Follow the steps described below to select the *F4* rotational difference setting.

Set Value LED Display Model Basic Model

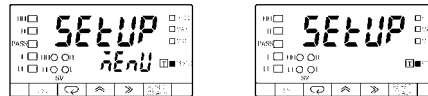

- 1, 2, 3...**
1. Press the Mode Key for more than one second while the *SETUP* setup menu is displayed. The *FUnC* operating mode setting will appear.

Set Value LED Display Model Basic Model

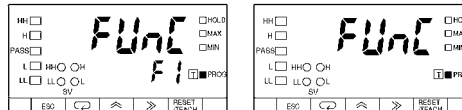

2. Press the Shift Key to display *F1* for changing. The PROG indicator will flash.

Set Value LED Display Model Basic Model

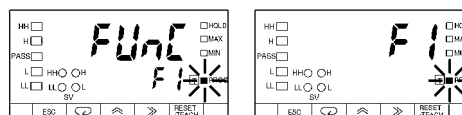

- Repeatedly press the Up Key until *F4* is displayed. The displayed setting will be validated automatically if no change is made for five seconds. The *FUnC* operating mode setting will be displayed again.

Note Press the Mode Key to enter the displayed setting immediately. The next parameter will be displayed for setting.

Set Value LED Display Model Basic Model

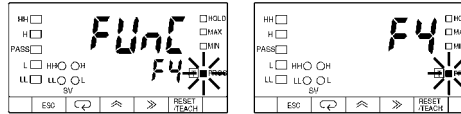

- Repeatedly press the Escape Key until the *SEtUP* setup menu is displayed.

Set Value LED Display Model Basic Model

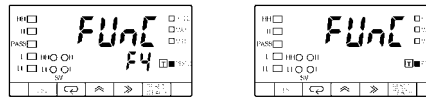

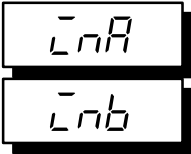

Sensor Type

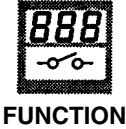

- Specifies the type of sensors for input A and input B.
- The sensor type of input B cannot be selected if the operating mode of the K3NR is set to *F1* (rotational/circumferential speed) or *FB* (passing time).
- Open Collector Input

Sensor type	Normally open	Normally closed	Default
Transistor input	00	01	00
Relay input	10	11	

Normally Open Model: The sensor output is OFF (open) when the sensor is not sensing an object.

Normally Closed Model: The sensor output is ON (closed) when the sensor is not sensing an object.

- Voltage Pulse Input

Sensor type	Active high (H)	Active low (L)	Default
Voltage pulse input	10	11	00

SETTING EXAMPLE

Follow the steps described below to set input A to *11* in operating mode *F1* (rotational/circumferential speed).

Set Value LED Display Model Basic Model

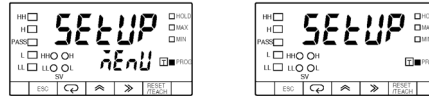

- 1, 2, 3... 1. Press the Mode Key for more than one second while the *SETUP* setup menu is displayed. The *FnC* operating mode setting will appear.

Set Value LED Display Model Basic Model

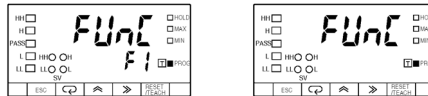

2. Press the Mode Key to display *LnA* input A sensor type setting.

Set Value LED Display Model Basic Model

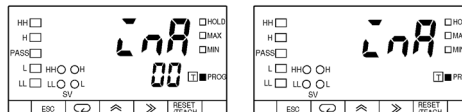

3. Press the Shift Key to display *00* for changing. The *PROG* indicator will flash.

Set Value LED Display Model Basic Model

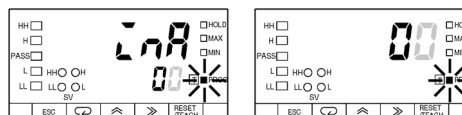

- Press the Up and Shift Keys to display *!!*. The displayed value will be validated automatically if no change is made for five seconds. The *LnA* input A sensor type setting will be displayed again.

Note Press the Mode Key to enter the displayed setting immediately. The next parameter will be displayed.

Set Value LED Display Model Basic Model

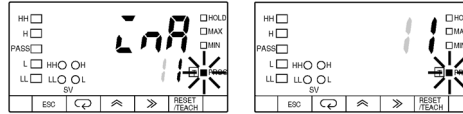

- Press the Escape Key to display the *SETUP* setup menu.

Set Value LED Display Model Basic Model

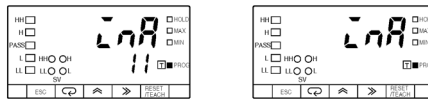



Auto Zero Time of Input A X (Mantissa)

Auto Zero Time of Input A Y (Exponent)

Auto Zero Time of Input B X (Mantissa)

Auto Zero Time of Input B Y (Exponent)

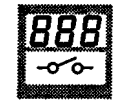

FUNCTION

Calibrates the process value to zero forcibly if no input pulse is received for a certain period. This period is called auto-zero time.

Refer to the following graph.

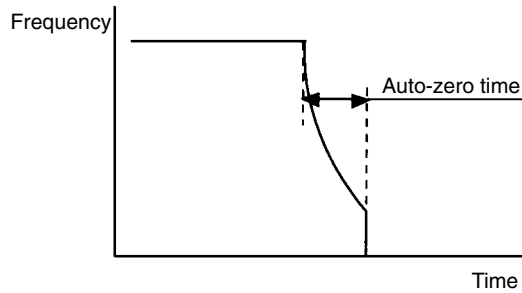

Logically, the input pulse frequency does not drop to zero perfectly due to the estimated frequency calculation of the K3NR. Therefore, the K3NR has a function to calibrate the frequency to zero forcibly if no input pulse is received for a certain period.

Automatic zero time is determined by the following formula.

Auto-zero time = $X \times 10^Y$ (s) (X: mantissa, Y: exponent)

Note Auto-zero time must be longer than the value obtained by dividing one by the minimum frequency input of the K3NR. Auto-zero time must not be less than 0.1 s.

If the operating mode of the K3NR is set to F7 (pulse counting), this parameter will not be available.



SETTING

Input type	Setting	Default
Er0.A0: Auto zero time of input A X (mantissa)	0.0001 to 9.9999	9.9999
Er0.AY: Auto zero time of input A Y (exponent)	-9 to 09	09
Er0.b0: Auto zero time of input B X (mantissa)	0.0001 to 9.9999	9.9999
Er0.bY: Auto zero time of input B Y (exponent)	-9 to 09	09



REFERENCE

Note For details, refer to page 129 for the estimated frequency calculation of the K3NR.

SETTING EXAMPLE

Follow the steps described below to set the value of auto-zero time to one second.

Set Value LED Display Model Basic Model

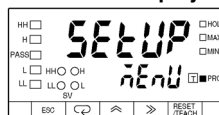

- 1, 2, 3... 1. Press the Mode Key for more than one second while the *SETUP* setup menu is displayed. The *FUNC* operating mode setting will appear.

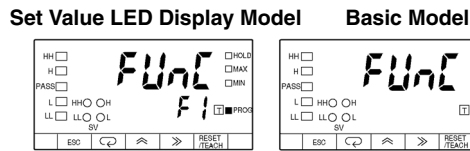

2. Repeatedly press the Mode Key until the *Er0.A0* auto zero time of input A X (mantissa) setting is displayed.

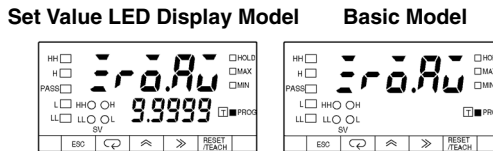

3. Press the Shift Key to display the set value *9.9999* for changing. The PROG indicator will flash.

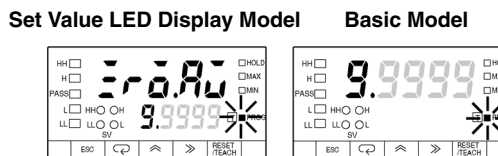

4. Press the Up and Shift Keys to set the value to *1.0000*. The input will be validated automatically if no change is made for five seconds. The *Er0.A0* auto zero time of input A X (mantissa) setting will be displayed again.

Note Press the Mode Key to enter the set value immediately. The auto zero time of input A Y (exponent) setting will be displayed for setting the next parameter.

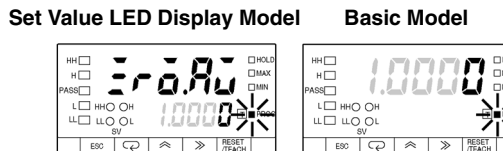

5. Press the Mode Key to display the *Er0.A4* auto zero time of input A Y (exponent) setting.

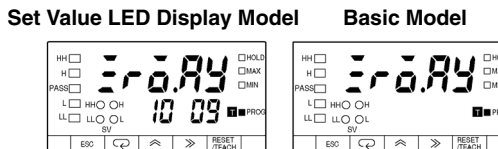

6. Press the Shift Key to display the set value *10 09* for changing.

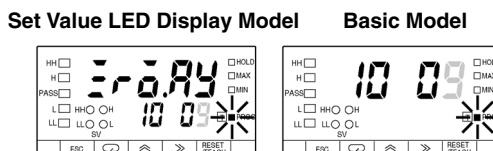

7. Press the Up and Shift Keys to set the value to *10 00*. The input will be validated automatically if no change is made for five seconds. The *Er0.A4* auto zero time of input A Y (exponent) setting will be displayed again.

Note Press the Mode Key to enter the set value immediately. The auto zero time of input B X (mantissa) setting will be displayed for setting the next parameter.

Set Value LED Display Model Basic Model

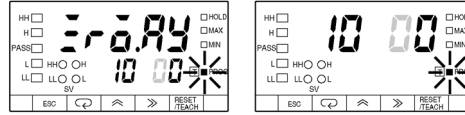

8. Press the Escape Key to display the *SETUP* setup menu.

Set Value LED Display Model Basic Model

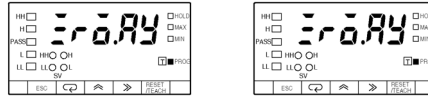

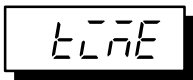

Time Unit



FUNCTION



SETTING

The time unit can be selected to display the calculation results of F6 (passing time).

Unit	Display range	Default
SCAL	-19999 to 99,999	SCAL
SEC	Displayed in seconds within a range between 0 and 99,999 s.	
min	Displayed minutes within a range between 0 and 99,999 min.	
H.min.SS	Displayed in hours, minutes, and seconds within a range between 0 h, 00 min, 00 s and 9 hrs, 59 min, 59 s.	
min.SS.d	Displayed in minutes and seconds (1/100 s) within a range between 00 min, 00 s 0 and 59 min, 59 s, 9.	

SETTING EXAMPLE

Follow the steps described below to set SEC second unit setting.

Set Value LED Display Model Basic Model

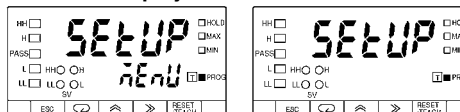

- 1, 2, 3...
1. Press the Mode Key for more than one second while the *SETUP* setup menu is displayed. The *Func* operating mode setting will appear.

Set Value LED Display Model Basic Model

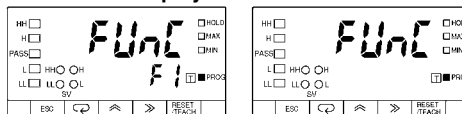

2. Repeatedly press the Mode Key until *tLnE* time unit setting is displayed.

Set Value LED Display Model Basic Model

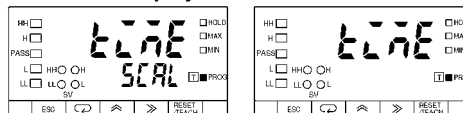

3. Press the Shift Key to display *SCAL* for changing. The PROG indicator will flash.

Set Value LED Display Model Basic Model

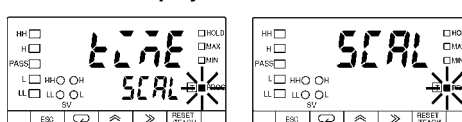

- Press the Up Key to display *SEC*. The input will be validated automatically if no change is made for five seconds. The *SEC* time unit setting will be displayed again.

Note Press the Mode Key to enter the set value immediately. The next parameter will be displayed for setting.

Set Value LED Display Model Basic Model

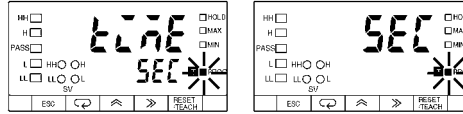

- Press the Escape Key to display the *SETUP* setup menu.

Set Value LED Display Model Basic Model

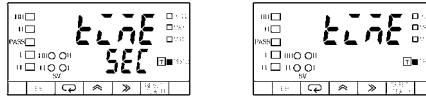

Set Value LED Display Model Basic Model



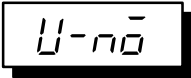

Communications Unit Number

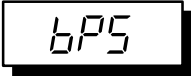

Baud Rate



FUNCTION

- Set a communications unit number as an identification number by which the host computer is connected to the K3NR.
- If more than one K3NR is connected in parallel, make sure that each communications unit number is unique.
- The baud rate should be set to the baud rate of the host computer.



SETTING

- Communications Unit Number

Setting range	Unit	Default
00 to 99	---	00

- Baud Rate

Setting range	Default
1200: 1,200 bps / 2400: 2,400 bps / 4800: 4,800 bps / 9600: 9,600 bps / 19200: 19.2 Kbps / 38400: 38.4 Kbps	9600



MODELS

This setting is available for the K3NR with the Communications Output Board.

SETTING EXAMPLE

Follow the steps described below to set the communications unit number to 15 and the baud rate to 19,200 bps.

Set Value LED Display Model

Basic Model

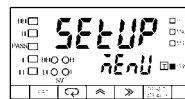

1, 2, 3...

1. Press the Mode Key for more than one second while the *SETUP* setup menu is displayed. The *FUnC* operating mode setting will appear.

Set Value LED Display Model

Basic Model



2. Repeatedly press the Mode Key until the *U-n0* communications unit number setting is displayed.

Set Value LED Display Model

Basic Model

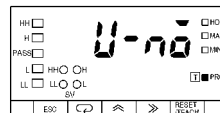
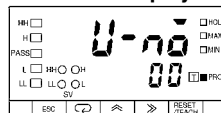

- Press the Shift Key to display the prior set value *00* for changing. The PROG indicator will flash.

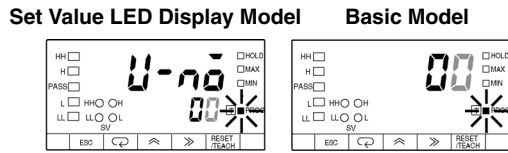

- Press the Up and Shift Keys to set the value to *15*. The input value will be validated automatically if no change is made for five seconds. The *U-nā* communications unit number setting will be displayed again.

Note Press the Mode Key to enter the set value immediately. The next parameter will be displayed for setting.

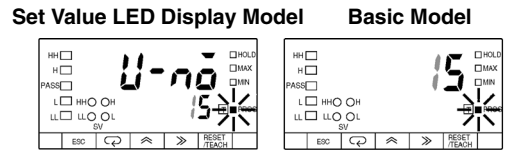

- Press the Mode Key to display the *bPS* baud rate setting.

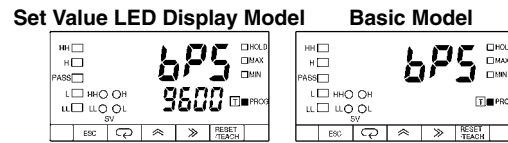

- Press the Shift Key to display the prior set value *9600* for changing. The PROG indicator will flash.

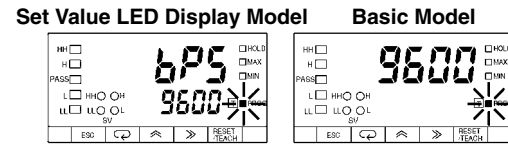

- Press the Up Key to set the value to *19200*. The input will be validated automatically if no change is made for five seconds. The *bPS* baud rate setting will be displayed again.

Note Press the Mode Key to enter the set value immediately. The next parameter will be displayed again for setting.

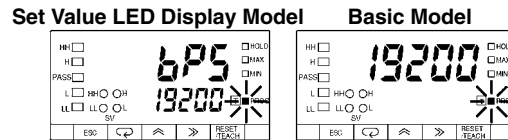

- Press the Up Key to enter the set value for setting the next parameter. The input value will be validated automatically if no change is made for five seconds. The *bPS* baud rate setting will be displayed again.



LEn

Word Length

Sbct

Stop Bits

Prty

Parity Bits



FUNCTION



SETTING

- The communications format used for communicating with the host computer is set in the setup menu.
- Refer to the *Communications Manual* for the communications format in detail.

- Word Length

Setting	Unit	Default
7/8	bit	7

- Stop Bits

Setting	Unit	Default
1/2	bit	2

- Parity Bit

Setting	Default
n̄n̄n̄E: None EuEn: Even ōdd: Odd	EuEn



MODELS

This setting is available for the K3NR with the Communications Output Board.

SETTING EXAMPLE

Follow the steps described below to set the following.

- Word length: 8 bits
- Number of stop bits: 1
- Parity bits: n̄n̄n̄E

Set Value LED Display Model



Basic Model



- 1, 2, 3... 1. Press the Mode Key for more than one second while the *SETUP* setup menu is displayed. The *FUnE* operating mode setting will appear.

Set Value LED Display Model



Basic Model



- Repeatedly press the Mode Key until the LEn word length setting is displayed.

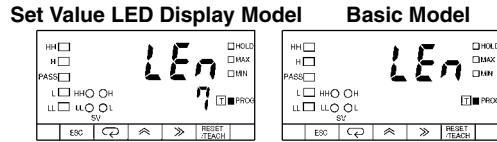

- Press the Shift Key to display the prior set value 7 for changing. The PROG indicator will flash.

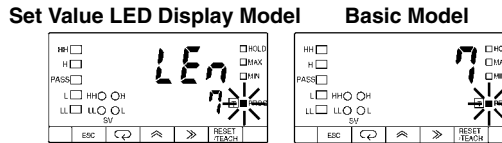

- Press the Up Key to set the value to 8. The input value will be validated automatically if no change is made for five seconds. The LEn word length setting will be displayed again.

Note Press the Mode Key to enter the set value immediately. The next parameter will be displayed for setting.

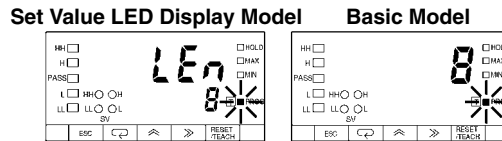

- Press the Mode Key to display the $5b\bar{c}t$ stop bit setting.

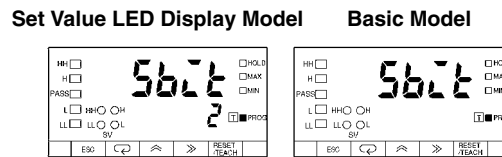

- Press the Shift Key to display the set value 2 for changing.

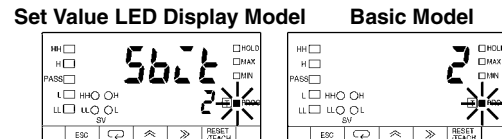

- Press the Up Key to set the value to 1. The input will be validated automatically if no change is made for five seconds. The $5b\bar{c}t$ stop bit setting will be displayed again.

Note Press the Mode Key to enter the set value immediately. The next parameter will be displayed for setting.

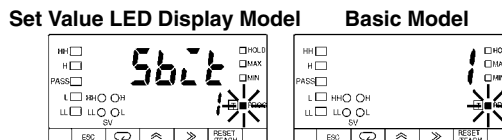

- Press the Mode Key to display the $P\bar{r}tY$ parity bit setting.

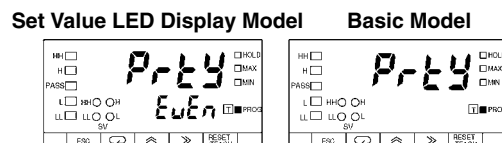

9. Press the Shift Key to display $E_{uE}n$ for changing.

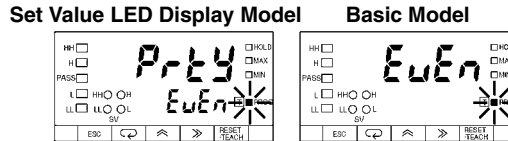

10. Press the Up Key to display $n\bar{o}nE$. The setting will be validated automatically if no change is made for five seconds. The $P_{rT}Y$ parity bit setting will be displayed again.

Note Press the Mode Key to enter the setting immediately. The next parameter will be displayed for setting.

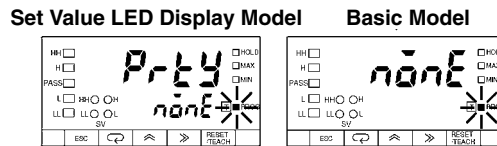

When no operation is executed for five seconds

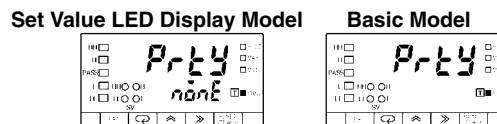

4-2-6 Option Menu (̄P̄t)



Process Time for Averaging Measured Value



FUNCTION



SETTING



REFERENCE

The K3NR averages its measured value at regular preset intervals. Therefore, when the K3NR is used to measure the rpm of a machine, for example, the value indicated by the PV display will be stable without being influenced by the fluctuation of the input pulse intervals or the rotation of the machine. If the input pulse intervals are larger than the preset regular intervals, the K3NR calculates the rpm using the input pulse intervals.

Setting	Default
<i>FRSt</i> : Averaged every 60 ms	<i>FRSt</i>
<i>0.5</i> : Averaged every 500 ms	
<i>1</i> : Averaged every 1 s	
<i>2</i> : Averaged every 2 s	
<i>4</i> : Averaged every 4 s	
<i>8</i> : Averaged every 8 s	
<i>16</i> : Averaged every 16 s	

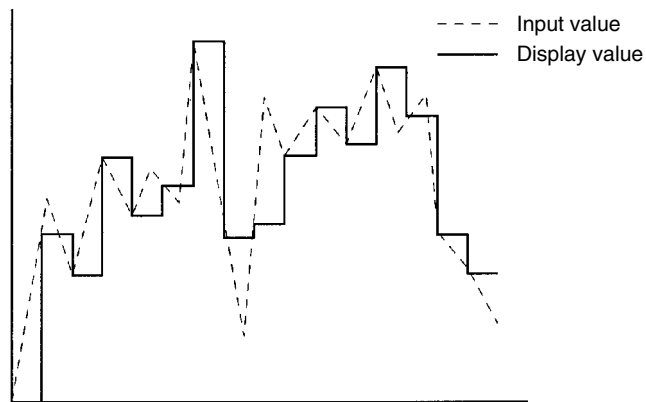

Without average processing

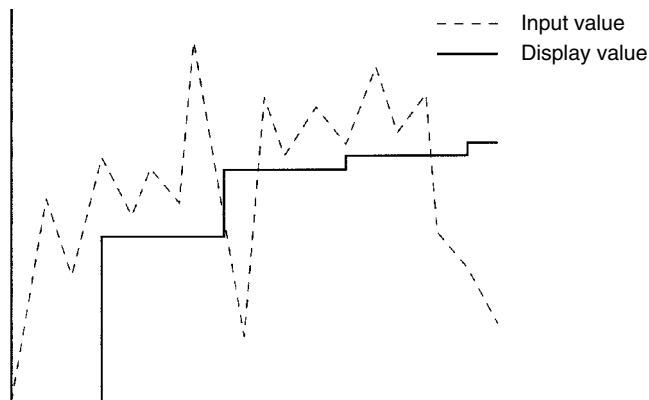

After average processing

SETTING EXAMPLE

Follow the steps described below to set the process time for averaging measured value to 4 s.

Set Value LED Display Model Basic Model

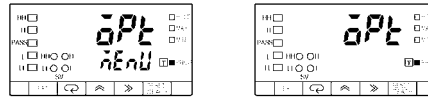

- 1, 2, 3...
1. Press the Mode Key for more than one second while the *dPt* option menu is displayed. The *AVG* process time for averaging measured value setting will appear.

Set Value LED Display Model Basic Model

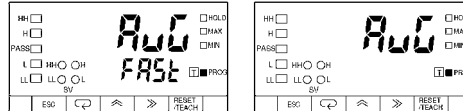

2. Press the Shift Key to display present set value *FAST* for changing. The PROG indicator will flash.

Set Value LED Display Model Basic Model

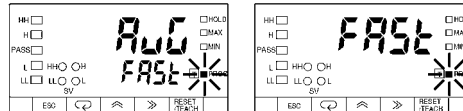

3. Repeatedly press the Up Key until *4* is displayed. The setting will be validated automatically if no change is made for five seconds. The *AVG* process time for averaging measured value setting will be displayed again.

Note Press the Mode Key to enter the displayed setting immediately. The next parameter will be displayed.

Set Value LED Display Model Basic Model

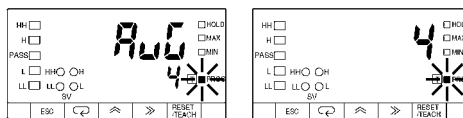

When no operation is executed for five seconds

Set Value LED Display Model Basic Model



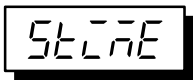

Startup Compensation Time



FUNCTION



SETTING



REFERENCE

- The interval between the moment the K3NR is turned and the moment the K3NR starts measurement operation is set in the option menu.
- The startup compensation time parameter keeps the measurement operation from sending an unnecessary output corresponding to instantaneous, fluctuating input from the moment the K3NR is turned ON until the end of the preset period.

Setting range	Unit	Default
0.0 to 99.9	S	0.0

The K3NR will display "00000" with all outputs turned OFF until the K3NR is in measurement operation.

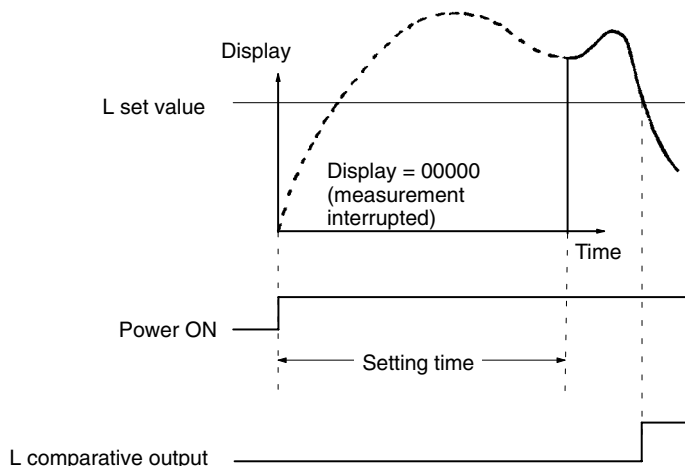

SETTING EXAMPLE

Follow the steps described below to set the startup compensation time to 2 seconds.

Set Value LED Display Model

Basic Model

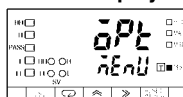

- 1, 2, 3... 1. Press the Mode Key for more than one second while the *dPt* option menu is displayed. The *AVG* process time for averaging measured value setting will appear.

Set Value LED Display Model

Basic Model

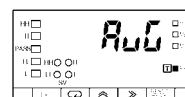
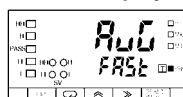

- Press the Mode Key to display the *StLnE* startup compensation time setting.

Set Value LED Display Model Basic Model

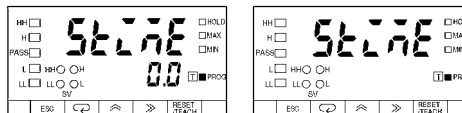

- Press the Shift Key to display the prior set value *00.0* for changing. The PROG indicator will flash.

Set Value LED Display Model Basic Model

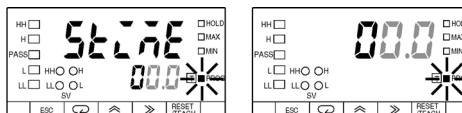

- Press the Up and Shift Keys to set the value to *02.0*. The setting will be validated automatically if no change is made for five seconds. The *StLnE* startup compensation time setting will be displayed again.

Note Press the Mode Key to enter the set value immediately. The next parameter will be displayed for setting.

Set Value LED Display Model Basic Model

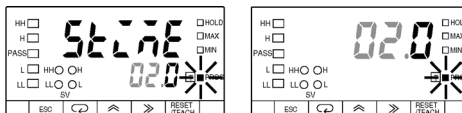

When no operation is executed for five seconds

Set Value LED Display Model Basic Model



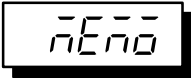

Power Failure Memory

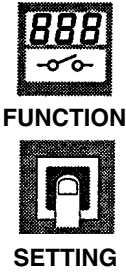

Retains the process value at the time of power failure if the operating mode of the K3NR is set to F7 (pulse counting).

Setting	Default
$\bar{o}n$: Stored	$\bar{o}FF$
$\bar{o}FF$: Not Stored	

SETTING EXAMPLE

Follow the steps described below to set $\bar{o}n$ to enable power failure memory.

Set Value LED Display Model Basic Model

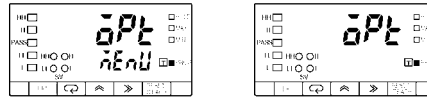

- 1, 2, 3... 1. Press the Mode Key for more than one second while the $\bar{o}Pt$ option menu is displayed. The Avg average processing setting will appear.

Set Value LED Display Model Basic Model

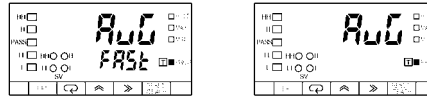

2. Repeatedly press the Mode Key until the $\bar{n}E\bar{n}\bar{o}$ power failure memory setting is displayed.

Set Value LED Display Model Basic Model

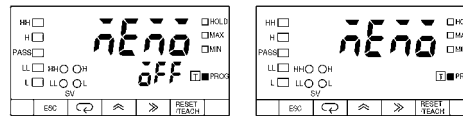

3. Press the Shift Key to display the set data $\bar{o}FF$ for changing. The PROG indicator will flash.

Set Value LED Display Model Basic Model

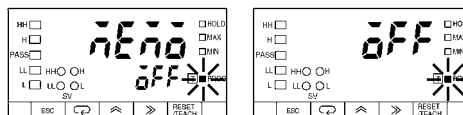

4. Press the Up Key to display $\bar{o}n$. The setting will be validated automatically if no change is made for five seconds. The $\bar{n}E\bar{n}\bar{o}$ power failure memory setting will be displayed again.

Note Press the Mode Key to enter the displayed setting immediately. The next parameter will be displayed for setting.

Set Value LED Display Model Basic Model

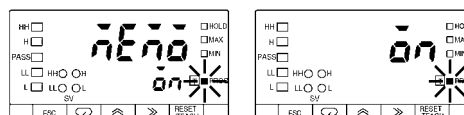

When no operation is executed for five seconds

Set Value LED Display Model Basic Model

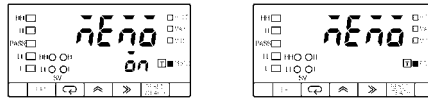

5. Press the Escape Key to display the òPŁ option menu.

Set Value LED Display Model Basic Model

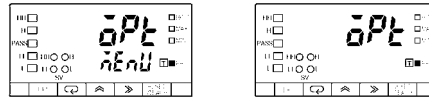

445

Hysteresis



FUNCTION



SETTING



REFERENCE

- The hysteresis can be set in the option menu to prevent “chattering” of the output if the measured value fluctuates in the vicinity of the setting values.
- The hysteresis can be set within a range of 1 and 9999 digits for four consecutive digits beginning with the leftmost digit regardless of the decimal point.
- The value set to 0 is regarded as 1.
- The decimal point position set in the scaling menu becomes valid.

Setting range	Unit	Default
1 to 9999	---	1

If the comparative output is a level output, however, the hysteresis will be enabled when the measured value starts to become smaller than the HH, H, LL, and L setting values.

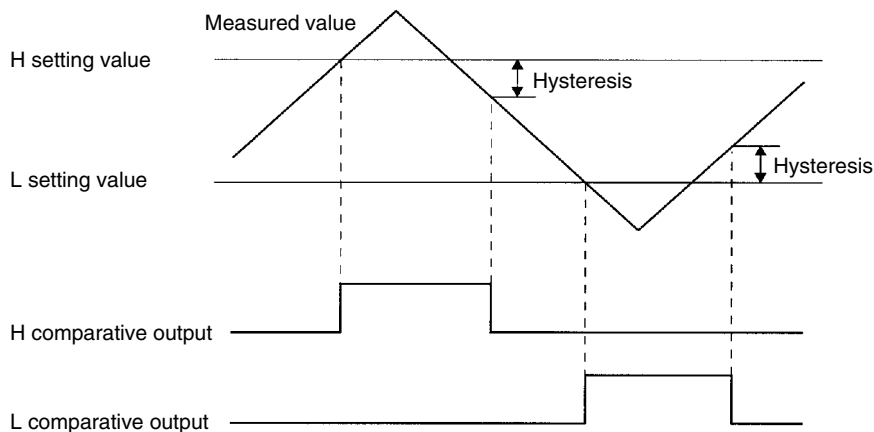

MODELS

This setting is only available for the K3NR with the Comparative Output Unit.

SETTING EXAMPLE

Follow the steps described below to set the hysteresis to 30.

Set Value LED Display Model

Basic Model

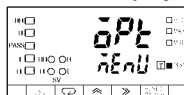

- 1, 2, 3... 1. Press the Mode Key for more than one second while the *dPt* option menu is displayed. The *Avg* average processing setting will appear.

Set Value LED Display Model

Basic Model

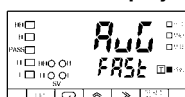

2. Repeatedly press the Mode Key until the *HYS* hysteresis setting is displayed.

Set Value LED Display Model Basic Model

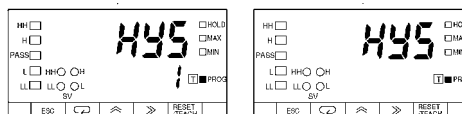

3. Press the Shift Key to display the prior set value *000 1* for changing. The PROG indicator will flash.

Set Value LED Display Model Basic Model

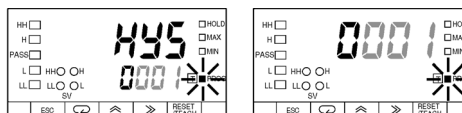

4. Press the Up and Shift Keys to set the value to *0030*. The setting will be validated automatically if no change is made for five seconds. The *HYS* hysteresis setting will be displayed again.

Note Press the Mode Key to enter the set value immediately. The next parameter will be displayed for setting.

Set Value LED Display Model Basic Model

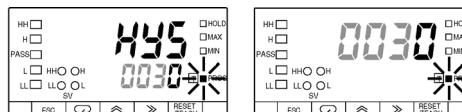

When no operation is executed for five seconds

Set Value LED Display Model Basic Model

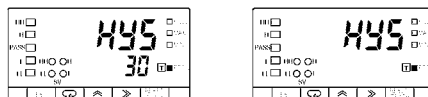

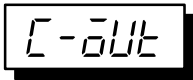

Comparative Output Pattern

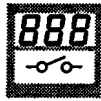

FUNCTION



SETTING

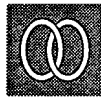

REFERENCE

- The pattern of HH, H, L, LL, and PASS comparative outputs is set in the option menu.
- This function is not available when the operating mode is set to “F7.”

Setting	Default
nōnRL: Standard output	nōnRL
zōnE: Zone output	
LEuEL: Level output	

Standard Output

H or HH Comparative Output:

Turns ON when the measured value is larger than the H or HH setting value.

PASS Output:

Turns ON when LL, L, H, and HH comparative outputs are all OFF.

L or LL Comparative Output:

Turns ON when the measured value is smaller than the L or LL setting value.

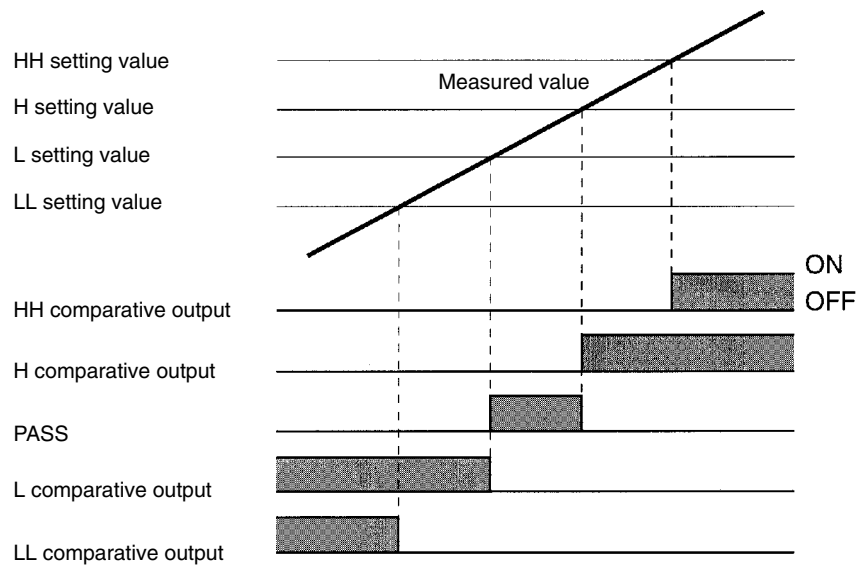

Level Output

LL, L, H, or HH Comparative Output:

Turns ON when the measured value exceeds the LL, L, H, or HH setting value.

PASS Output:

Turns ON when the LL, L, H, and HH comparative outputs are all OFF.

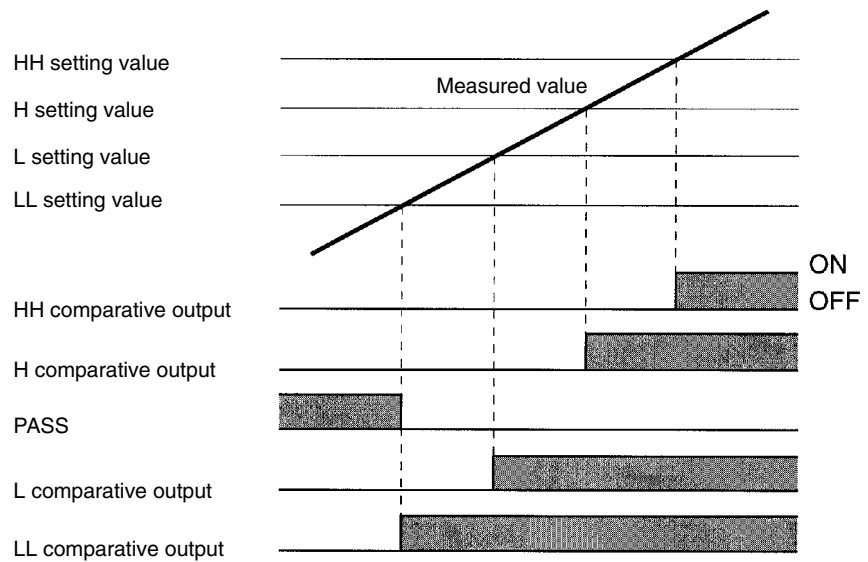

Zone Output

HH Comparative Output:

Turns ON when the measured value exceeds the HH setting value.

H Comparative Output:

Turns ON when the measured value is between the H and HH setting values.

PASS Output:

Turns ON when the measured value is between the L and H setting values.

L Comparative Output:

Turns ON when the measured value is between the LL and L setting values.

LL Comparative Output:

Turns ON when the measured value falls below the LL setting value.

Be sure to set the setting values so they satisfy the following formula:

$$LL < L < H < HH$$

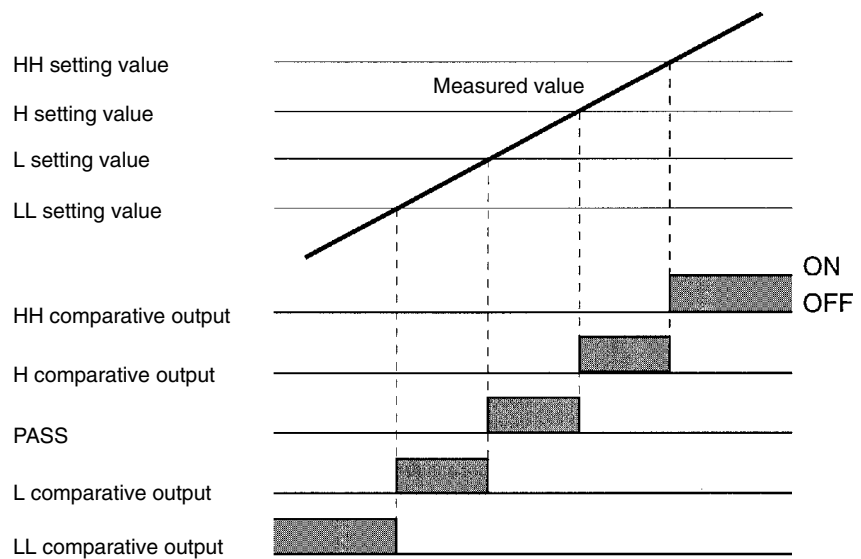



MODELS

This setting is only available for the K3NR with the Comparative Output Unit.

SETTING EXAMPLE

Follow the steps described below to set the comparative output pattern to level output.

Set Value LED Display Model Basic Model

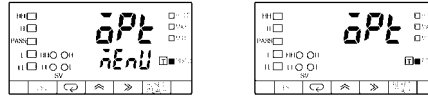

- 1, 2, 3...
1. Press the Mode Key for more than one second while the *dPt* option menu is displayed. The *AVG* process time for averaging measured value setting will appear.

Set Value LED Display Model Basic Model



2. Repeatedly press the Mode Key until the *C-out* comparative output pattern setting is displayed.

Set Value LED Display Model Basic Model

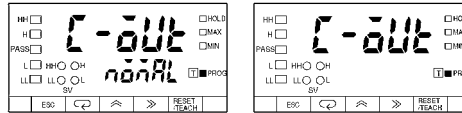

3. Press the Shift Key to display the prior setting *nORL* for changing. The PROG indicator will flash.

Set Value LED Display Model Basic Model

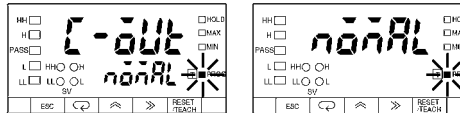

4. Press the Up Key twice to display *LEVEL*. The setting will be validated automatically if no change is made for five seconds. The *C-out* comparative output pattern setting will be displayed again.

Note Press the Mode Key to enter the setting immediately. The next parameter will be displayed for setting.

Set Value LED Display Model Basic Model

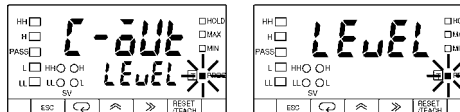

When no operation is executed for five seconds

Set Value LED Display Model Basic Model



L5Et.H

Upper Limit (H) of Linear Output Range

L5Et.L

Lower Limit (L) of Linear Output Range



FUNCTION

Linear output setting is made in the option menu to enable the K3NR to have voltage or current output in proportion to the change in display value.

- The maximum and minimum values of linear output are set in this parameter.

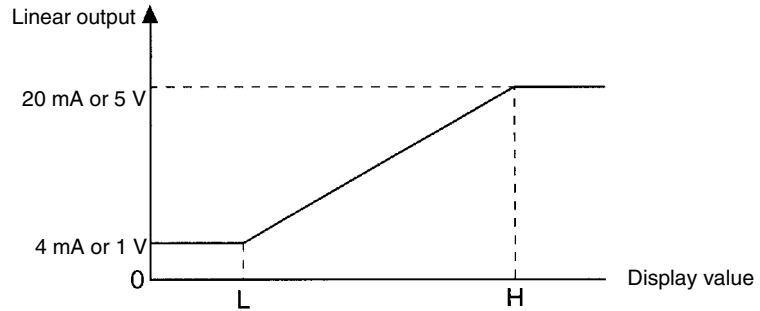

- L can be greater or less than H.
- L cannot be the same as H, otherwise H will be automatically set to a value obtained by adding 1 to L.
- The teaching function can be used for setting linear output ranges.



SETTING

Setting range	Default	
-19999 to 99999	H linear output range	99999
	L linear output range	-19999

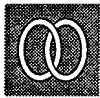

REFERENCE

Refer to 6-1 Teaching Function.



MODELS

This setting is available for the K3NR with the Linear Output Board.

SETTING EXAMPLE

Follow the steps described below to set the following.

H: 100.00

L: 0.00

(Assume that the decimal point is set between the 2nd and 3rd digit from the right in the prescale menu.)

Set Value LED Display Model

Basic Model



- 1, 2, 3...
1. Press the Mode Key for more than one second while the *dPt* option menu is displayed. The *RUG* process time for averaging measured value setting will appear.

Set Value LED Display Model

Basic Model

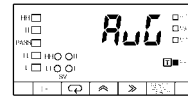

2. Repeatedly press the Mode Key until the *LSEt.H* H linear output range setting is displayed.

Set Value LED Display Model

Basic Model

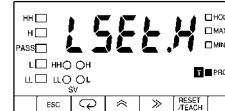
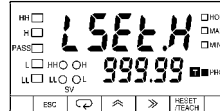

3. Press the Shift Key to display the prior set value *999.99* for changing. The PROG indicator will flash.

Set Value LED Display Model

Basic Model

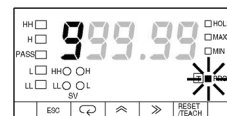
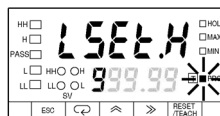

4. Press the Up and Shift Keys to set the value to *100.00*. The setting will be validated automatically if no change is made for five seconds. The *LSEt.H* H linear output range setting will be displayed again.

Note Press the Mode Key to enter the set value immediately. The next parameter will be displayed for setting.

Set Value LED Display Model

Basic Model

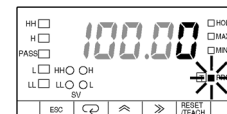

5. Press the Mode Key to display the *LSEt.L* L linear output range setting.

Set Value LED Display Model

Basic Model

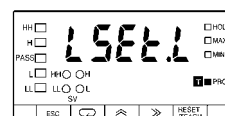
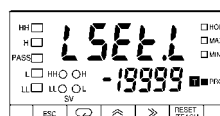

- Press the Shift Key to display the prior set value - 199.99 for changing. The PROG indicator will flash.

Set Value LED Display Model Basic Model

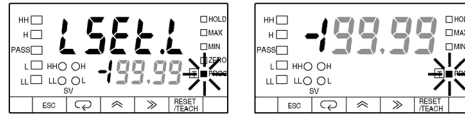

- Press the Up and Shift Keys to set the value to 000.00. The setting will be validated automatically if no change is made for five seconds. The L5EEL.L linear output range setting will be displayed again.

Note Press the Mode Key to enter the set value immediately. The next parameter will be displayed for setting.

Set Value LED Display Model Basic Model

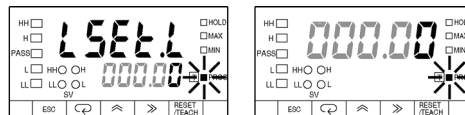

When no operation is executed for five seconds

Set Value LED Display Model Basic Model

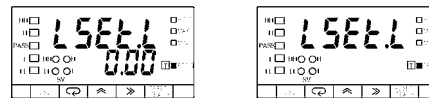

r-L

Remote/Local Programming

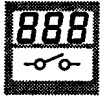

FUNCTION



SETTING

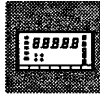

MODELS

- The K3NR can be set to remote or local mode in the option menu. The K3NR in remote mode is operated through the host computer and the K3NR in local mode is operated through the front panel key input.

Setting	Default
Remote: r \bar{n} l	L \bar{L} L
Local: L \bar{L} L	

This setting is available for the K3NR with the Communications Output Board.

SETTING EXAMPLE

Follow the steps described below to set the K3NR to remote programming.

Set Value LED Display Model Basic Model

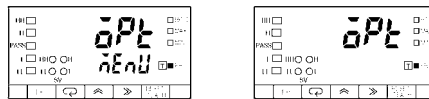

- 1, 2, 3...
- Press the Mode Key for more than one second while the $\bar{o}P\bar{l}$ option menu is displayed. The $R\bar{u}l$ setting will appear.

Set Value LED Display Model Basic Model

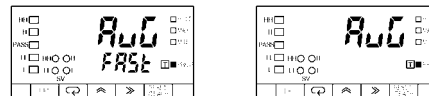

- Repeatedly press the Mode Key until the r-L remote/local setting is displayed.

Set Value LED Display Model Basic Model

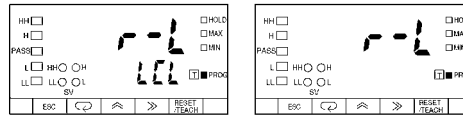

- Press the Shift Key to display the prior setting L \bar{L} L for changing. The PROG indicator will flash.

Set Value LED Display Model Basic Model

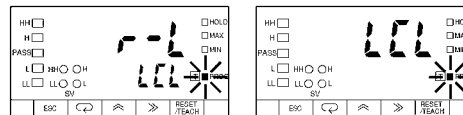

- Press the Up Key to display r \bar{n} l.

Set Value LED Display Model Basic Model

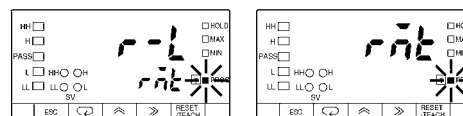

4-3 Protect Mode

4-3-1 Selecting Protect Mode

- The K3NR in RUN mode will go into protect mode if the Escape and Up Keys are pressed for more than 1 second.
- The K3NR in protect mode will go into RUN mode if the Escape Key is pressed.

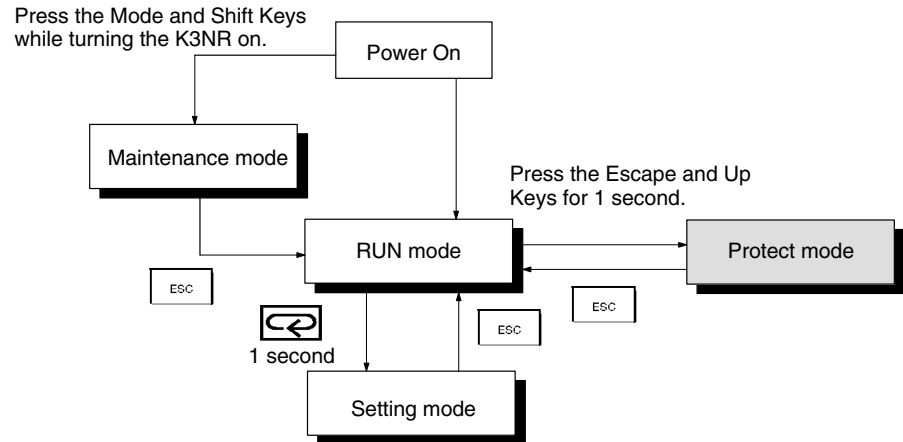

- If the Mode Key is pressed for more than one second while a menu is displayed, a parameter will be displayed.
- The parameter changes whenever the Mode Key is pressed.
- If the Shift Key is pressed while a parameter is displayed, the parameter will be ready to change.
- Press the Up Key to change parameters.

4-3-2 Menu Overview

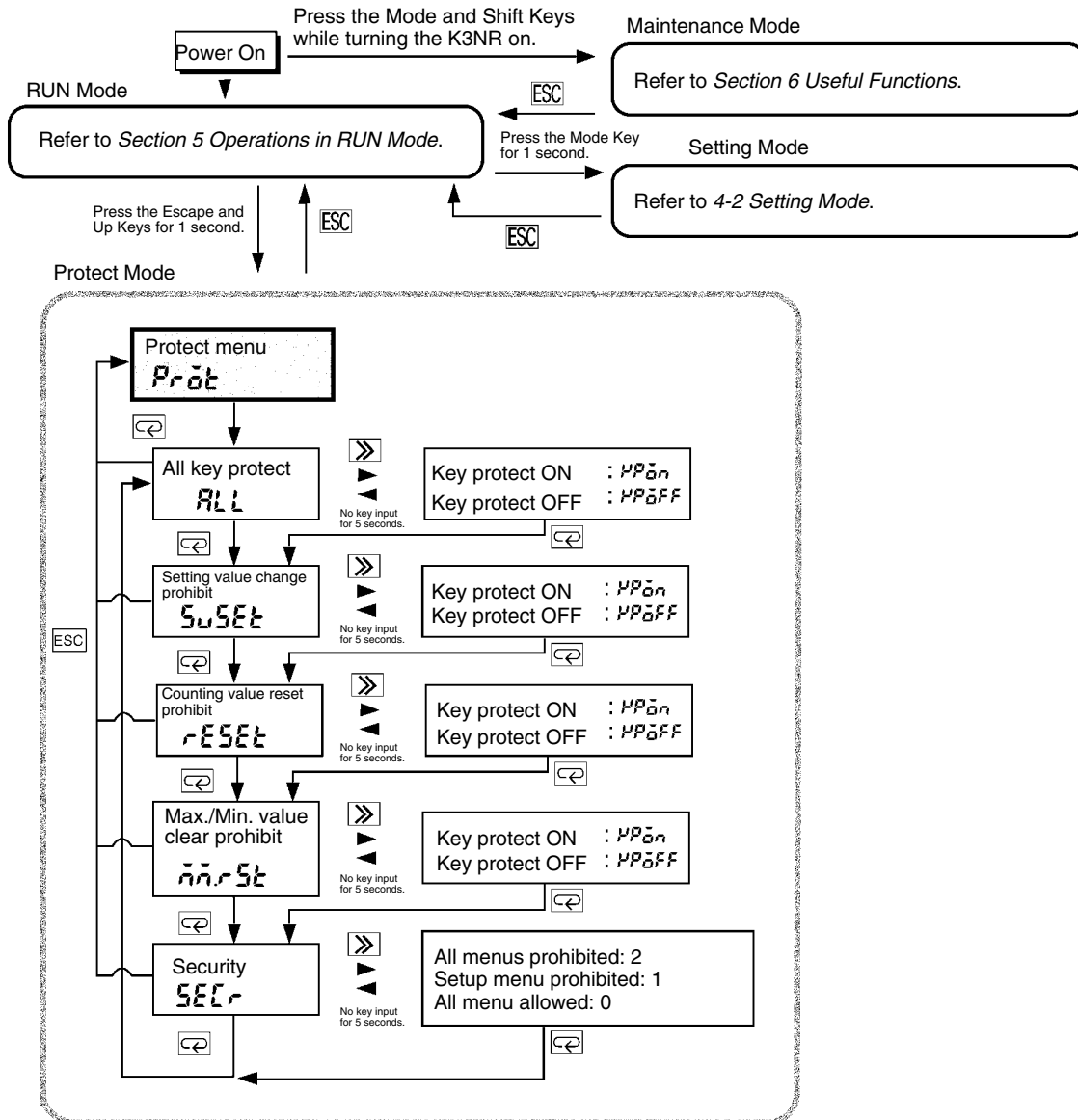

- Note**
1. The K3NR stops measurement in setting mode.
 2. Some menus cannot be set due to the display type or output type selected.

4-3-3 Protect Menu (*Pröt*)

ALL

All Key Protect



FUNCTION



SETTING

- The operation of all keys can be prohibited in the protect menu.

Setting	Default
<i>HPön</i> : Key protect ON	<i>HPöFF</i>
<i>HPöFF</i> : Key protect OFF	

SETTING EXAMPLE

Follow the steps described below to set the key protect to ON.

Set Value LED Display Model Basic Model

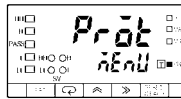

- 1, 2, 3...
- Press the Mode Key for more than one second while the *Pröt* protect menu is displayed. The *ALL* all key protect setting will appear.

Set Value LED Display Model Basic Model

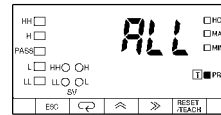
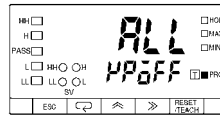

- Press the Shift Key to display the prior setting *HPöFF* for changing. The PROG indicator will flash.

Set Value LED Display Model Basic Model

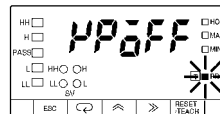
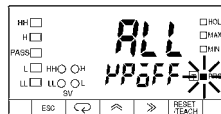

- Press the Up Key to display *HPön*. The setting will be validated automatically if no change is made for five seconds. The *ALL* all key protect setting will be displayed again.

Note Press the Mode Key to enter the setting immediately. The next parameter will be displayed for setting.

Set Value LED Display Model Basic Model

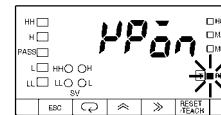
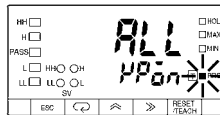

When no operation is executed for five seconds

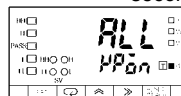

SuSEt

Setting Value Change Prohibit



FUNCTION

- The setting value change of the K3NR in RUN mode with the front-panel key inputs can be prohibited in the protect menu.



SETTING

Setting	Default
HP _{On} : Key protect ON	HP _{OFF}
HP _{OFF} : Key protect OFF	

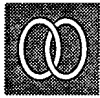

REFERENCE

Refer to 5-1 Checking and Changing Setting Values.

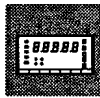

MODELS

This setting is only available for the K3NR with the Comparative Output Unit.

SETTING EXAMPLE

Follow the steps described below to set the setting value change prohibit to ON.

Set Value LED Display Model Basic Model

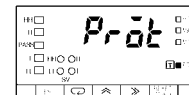
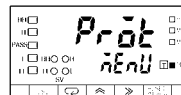

- 1, 2, 3...
1. Press the Mode Key for more than one second while the *PrOt* protect menu is displayed. The *ALL* all key protect setting will appear.

Set Value LED Display Model Basic Model

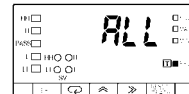
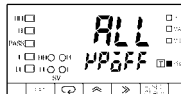

2. Press the Mode Key to display the *SuSEt* setting value prohibit setting.

Set Value LED Display Model Basic Model

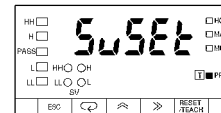
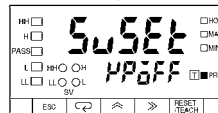

3. Press the Shift Key to display the prior setting *HPoFF* for changing. The PROG indicator will flash.

Set Value LED Display Model Basic Model

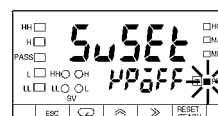

- Press the Up Key to display $HP\bar{O}n$. The setting will be validated automatically if no change is made for five seconds. The $SuSEt$ setting value prohibit setting will be displayed again.

Note Press the Mode Key to enter the setting immediately. The next parameter will be displayed for setting.

Set Value LED Display Model Basic Model

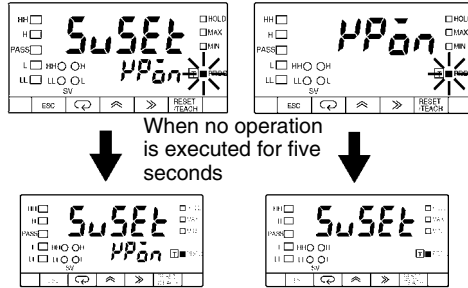

rESEt

Counting Value Reset Prohibit



FUNCTION

- Prohibits the counting value resetting of the K3NR when its operating mode is set to “F7” (pulse counting).
- This function does not prohibit the counting value resetting of the K3NR with external signal input.



SETTING

Setting	Default
HP _{on} : Key protect ON	HP _{OFF}
HP _{OFF} : Key protect OFF	

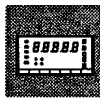

MODELS

Refer to 5-3 External Input Signals.

SETTING EXAMPLE

Follow the steps described below to set key protect ON.

Set Value LED Display Model Basic Model

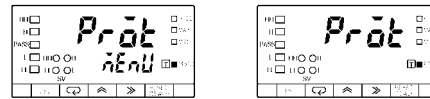

- 1, 2, 3... 1. Press the Mode Key for more than one second while the *Pröt* protect menu is displayed. The *ALL* all key protect setting will appear.

Set Value LED Display Model Basic Model

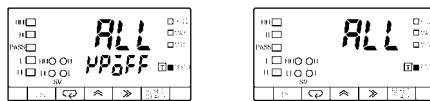

2. Press the Mode Key to display *rESEt* Counting Value Reset Prohibit setting.

Set Value LED Display Model Basic Model

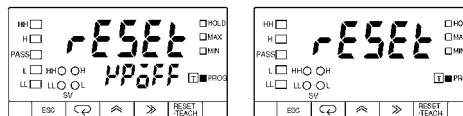

3. Press the Shift Key to display *HP_{OFF}* for changing. The PROG indicator will flash.

Set Value LED Display Model Basic Model

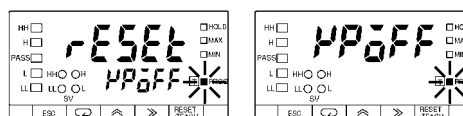

- Press the Up Key to display $HP\bar{O}n$. The setting will be validated automatically if no change is made for five seconds. The $rESEt$ counting value reset prohibit setting will be displayed again.

Note Press the Mode Key to enter the setting immediately. The next parameter will be displayed for setting.

Set Value LED Display Model Basic Model

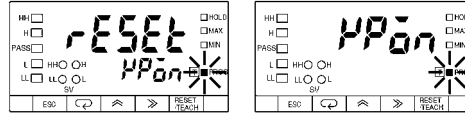

When no operation is executed for five seconds

Set Value LED Display Model Basic Model

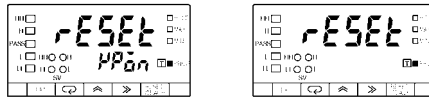

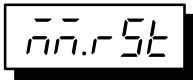

Maximum/Minimum Value Clear Prohibit

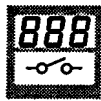

FUNCTION



SETTING

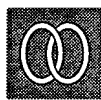

REFERENCE

- The resetting of maximum and minimum values with key input can be prohibited in the protect menu. However, the resetting of maximum and minimum values with external signal input is permitted.

Setting	Default
HP $\bar{O}n$: Key protect ON	HP $\bar{O}FF$
HP $\bar{O}FF$: Key protect OFF	

Refer to 5-3 Checking and Resetting of Maximum and Minimum Values.

SETTING EXAMPLE

Follow the steps described below to set the maximum/minimum value clear prohibit to ON.

Set Value LED Display Model Basic Model

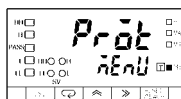

- 1, 2, 3...
- Press the Mode Key for more than one second while the *PrOt* protect menu is displayed. The *ALL* all key protect setting will appear.

Set Value LED Display Model Basic Model

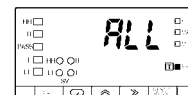
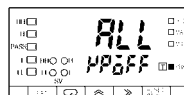

- Repeatedly press the Mode Key until the *n.n.rSt* maximum/minimum value clear prohibit setting is displayed.

Set Value LED Display Model Basic Model

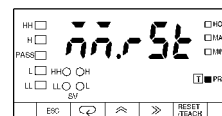
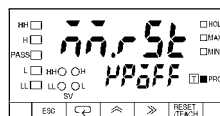

- Press the Shift Key to display the prior setting *HP̄OFF* for changing. The PROG indicator will flash.

Set Value LED Display Model Basic Model

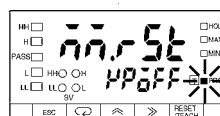

- 4. Press the Up Key to display $HP\bar{a}n$. The setting will be validated automatically if no change is made for five seconds. The $\bar{a}\bar{a}.rSt$ maximum/minimum value clear prohibit setting will be displayed again.

Note Press the Mode Key to enter the setting immediately. The next parameter will be displayed for setting.

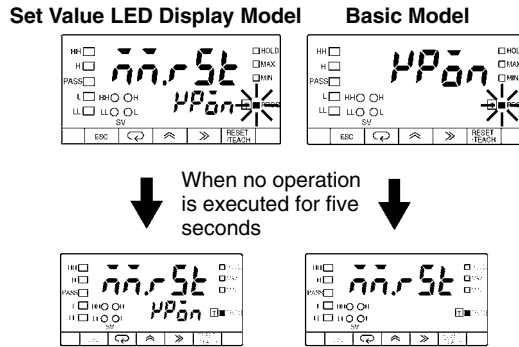



Security



- Settings in setting mode can be prohibited in the protect menu.
- The following table shows what set values for menus can be prohibited. The default is 0.

Menu	Set value		
	0	1	2
Setting value			Prohibited
Prescaling			Prohibited
Setup		Prohibited	Prohibited
Option			Prohibited

- The value changes in the following order with the Up Key: 0, 1, 2, and 0

SETTING EXAMPLE

Follow the steps described below to set the security setting to 1.

Set Value LED Display Model Basic Model



- 1, 2, 3...
1. Press the Mode Key for more than one second while the *Pröt* protect menu is displayed. The *ALL* all key protect setting will appear.

Set Value LED Display Model Basic Model



2. Repeatedly press the Mode Key until the *SECr* security setting is displayed.

Set Value LED Display Model Basic Model

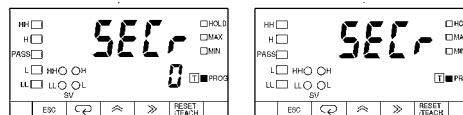

3. Press the Shift Key to display the prior set value *0* for changing. The PROG indicator will flash.

Set Value LED Display Model Basic Model

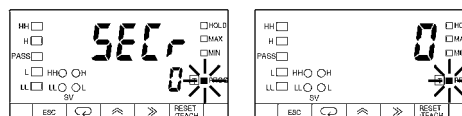

- 4. Press the Up Key to display *i*. The setting will be validated automatically if no change is made for five seconds. The *SEC* security setting will be displayed again.

Note Press the Mode Key to enter the setting immediately. The next parameter will be displayed for setting.

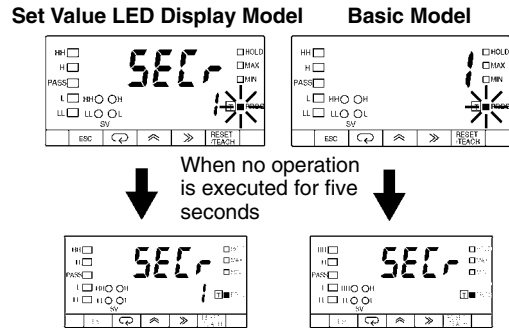

SECTION 5

Operations in RUN Mode

This section provides instructions for operating the K3NR in RUN mode.

- 5-1 Displaying and Changing Setting Values 100
 - 5-1-1 Displaying Setting Values 100
 - 5-1-2 Changing Setting Values 100
- 5-2 Displaying and Resetting of Maximum and Minimum Values (Operating Modes F1 to F6) 103
 - 5-2-1 Displaying Maximum and Minimum Values 103
 - 5-2-2 Resetting Maximum and Minimum Values 103
- 5-3 External Input Signals 104
 - 5-3-1 Bank Selection 104
 - 5-3-2 RESET (Operating Modes F1 to F6) 104
 - 5-3-3 RESET (Operating Mode F7) 105
 - 5-3-4 HOLD (Operating Modes F1 to F6) 105
 - 5-3-5 HOLD (Operating Mode F7) 106

5-1 Displaying and Changing Setting Values

5-1-1 Displaying Setting Values

Basic Model

- When the Mode Key is pressed in RUN mode, the K3NR displays a setting value on the PV display (in the order of HH, H, L, and LL).
- While the setting value is displayed, the corresponding SV display status indicator is lit.
- Unless another operation key is pressed within five seconds after the setting value is displayed, the process, maximum, or minimum value is displayed again.

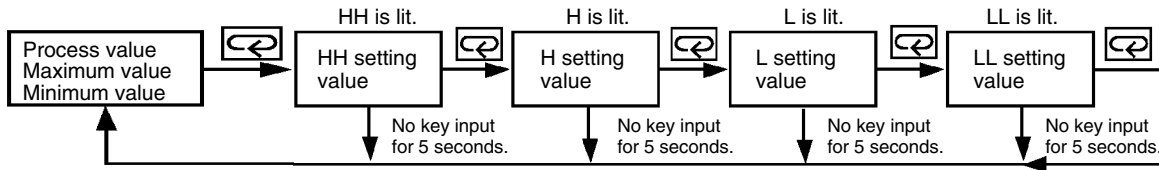

Set Value LED Display Model

- The setting value appears on the SV display and the corresponding SV display status indicator is lit while the process, maximum, or minimum value is displayed on the PV display
- When the Mode Key is pressed, the K3NR displays a setting value (in the order of HH, H, L, and LL) on the SV display.

5-1-2 Changing Setting Values

- Setting values can be prohibited against change when key protect or setting value change prohibit is ON in protect mode.
- Select the setting value to be changed with the Mode Key.
- All digits will be displayed and ready for changing if the Shift Key is pressed.
- Press the Up and Shift Keys to change the displayed setting value. The input will be entered if nothing else is input within five seconds. The input is entered immediately by pressing the Mode Key.
- The next setting value will be displayed and ready for changing if the Mode Key is pressed. If nothing else is input within five seconds, the setting value will be entered and the previous setting value will be displayed.
- The setting value can be changed through communications if the K3NR is a model with a communications function.

SETTING EXAMPLE

Basic Model

Follow the steps below to change the H setting value from 600 to 700 while the process value is displayed in RUN mode.

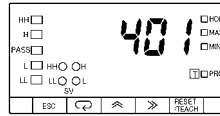

- 1, 2, 3... 1. Press the Mode Key to display the HH setting value and to light the HH indicator of the SV display status indicators.

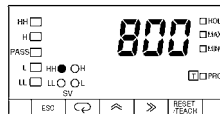

2. Press the Mode Key again to display the H setting value H and light the H indicator.

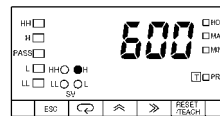

3. Press the Shift Key to display all the digits of the prior setting value 600 for changing.

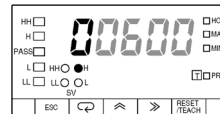

4. Press the Up and Shift Keys to set the value to 00700.

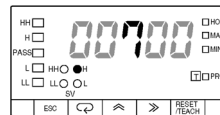

5. The input will be entered if nothing else is input within five seconds.
 or Press the Mode Key to display the L setting value for changing. The H setting value will appear again if nothing else is input within five seconds.

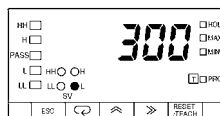

6. To return to the process value display, perform one of the following.
- Repeatedly press the Mode Key until the process value appears.
 - Leave the K3NR with no key input for five seconds.

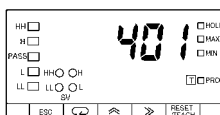

SETTING EXAMPLE

Set Value LED Display Model

Follow the steps below to change the H setting value from 600 to 700 while the process value is displayed in RUN mode, provided that the HH setting value is already displayed on the SV display.

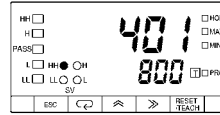

- 1, 2, 3...** 1. Press the Mode Key to display the H setting value and to light the H indicator of the SV display status indicators.

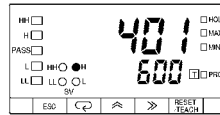

2. Press the Shift Key to display all the digits of the setting value 600 for changing.



3. Press the Up and Shift Keys to set the value to 00700.



4. The input will be entered if nothing else is input within five seconds.
 or Press the Mode Key to display the L setting value for changing. The H setting value will appear again if nothing else is input within five seconds.

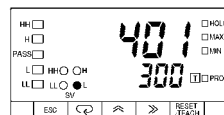

5-2 Displaying and Resetting of Maximum and Minimum Values (Operating Modes F1 to F6)

The maximum and minimum values are refreshed automatically while the K3NR is in measurement operation.

5-2-1 Displaying Maximum and Minimum Values

- The Escape Key is used to select the process, maximum, or minimum value to be displayed on the PV display in RUN mode.
- The corresponding SV display indicator (i.e., the MAX or MIN indicator) is lit while the maximum or minimum value is displayed.

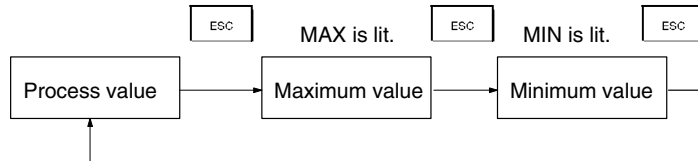

5-2-2 Resetting Maximum and Minimum Values

- The maximum and minimum values are reset when the K3NR is turned on, set to RUN mode, or reset.
- The K3NR will be reset when one of the following is performed.
 - The RESET/TEACH Key is pressed for more than one second while the maximum or minimum value is displayed.
 - The external RESET input signal is turned ON.
 - The K3NR receives the reset command through communications.
- When the K3NR is reset, the maximum and minimum values are set to the process value.

Note The K3NR cannot be reset with the RESET/TEACH Key if the maximum/minimum value clear prohibit is ON in protect mode.

SETTING EXAMPLE

- 1, 2, 3... 1. The process value 401 is displayed.

Set Value LED Display Model Basic Model

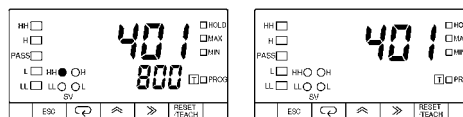

2. Press the Escape Key to display the maximum value 1024 and light the MAX indicator.

Set Value LED Display Model Basic Model

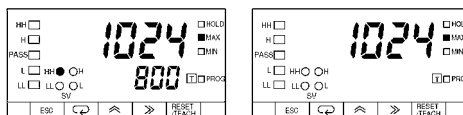

- Press the RESET/TEACH Key to set the maximum and minimum values to the process value 401.

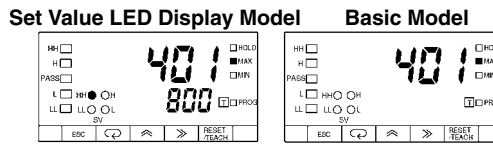

- Press the Escape Key to check that the minimum value is set to 401.

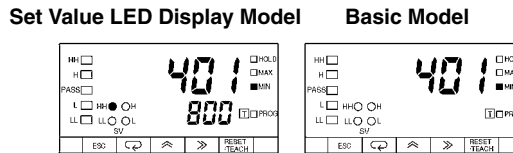

5-3 External Input Signals

5-3-1 Bank Selection

- The K3NR uses BANK1 and BANK2 signals to select the setting value, prescaling value, and decimal point position of the bank 1, 2, 3, or 4.

Refer to the following for the relationship between BANK input signals and bank numbers.

Bank no.	Control input		Comparative set value	Prescaling value
	BANK 1	BANK 2		
1	OFF	OFF	$S_{U1.**}$	$P_{S1.**}$
2	ON	OFF	$S_{U2.**}$	$P_{S2.**}$
3	OFF	ON	$S_{U3.**}$	$P_{S3.**}$
4	ON	ON	$S_{U4.**}$	$P_{S4.**}$

Note If the prescaling bank is set to OFF, the P_{SCL} prescaling value for each bank will be fixed.

- When a bank is selected, the corresponding BANK indicator 1, 2, 3, or 4 will be lit.
- It takes up to 100 ms for a bank switching after BANK1 and BANK2 signals are input.

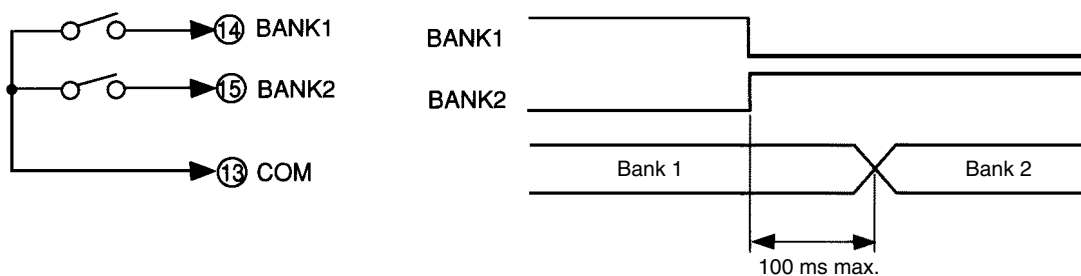

The bank number can be displayed on the PV or SV display by pressing the Shift Key for more than one second while the K3NR is in measurement operation. If there is no key input for three seconds, the K3NR will be in measurement operation again.

5-3-2 RESET (Operating Modes F1 to F6)

- Refer to 5-3 *Displaying and Resetting of Maximum and Minimum Values* for the function of this signal.

- The following graph shows the operation timing of the signal.

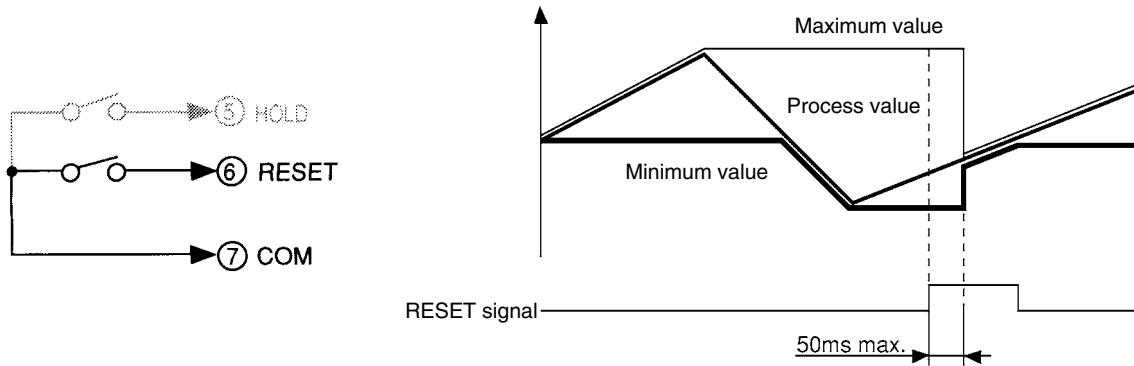

5-3-3 RESET (Operating Mode F7)

- If a RESET signal is ON, the counting value will be reset to zero forcibly.
- It takes up to 16 ms for the counting value to be reset to zero after a RESET signal is input.

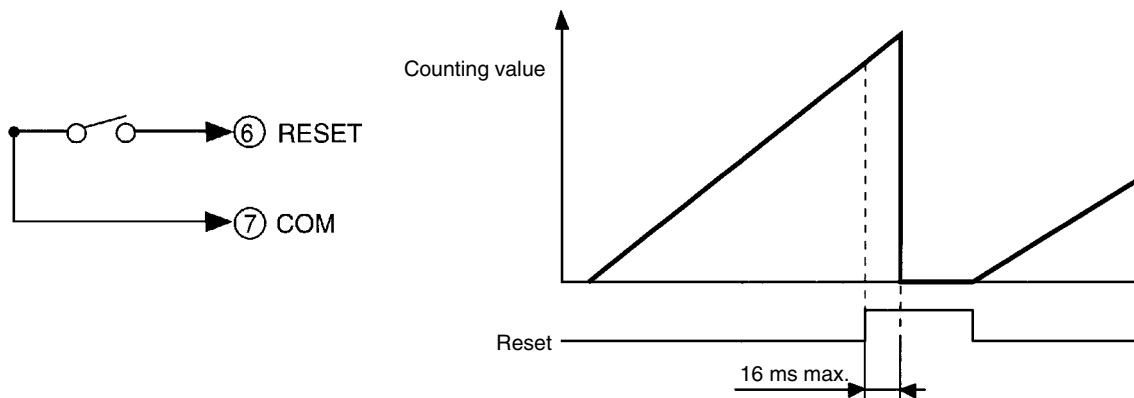

It is possible to reset the counting value by pressing the RESET/TEACH Key.

5-3-4 HOLD (Operating Modes F1 to F6)

- The K3NR will stop the measurement if the HOLD input is ON.
- When the HOLD input is ON, the K3NR will retain the process value, output, and BCD data effective immediately before the HOLD input.
- The HOLD indicator is lit while HOLD input is ON.

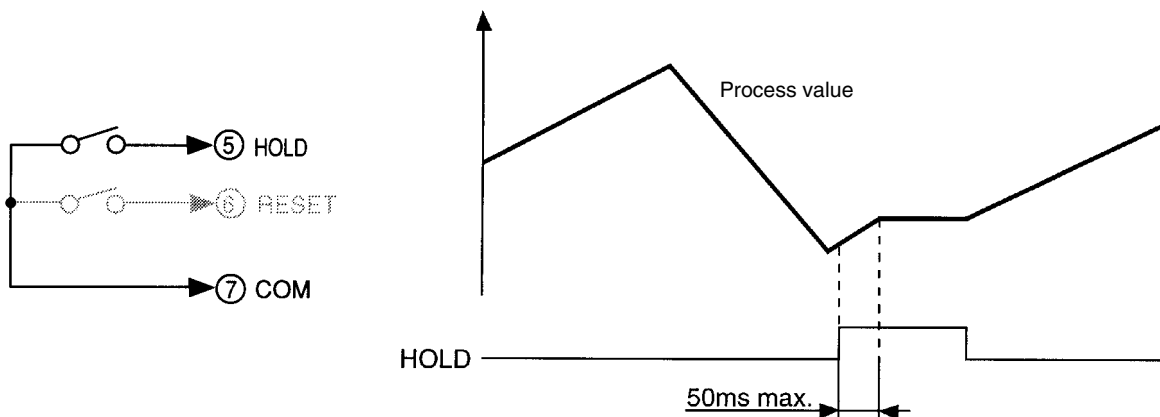

5-3-5 HOLD (Operating Mode F7)

- If HOLD input is ON, the counting value is on hold.
- The K3NR is in counting operation continuously while HOLD input is ON and comparative output and BCD data are available regardless of the HOLD input.
- The HOLD indicator is lit while HOLD input is ON.

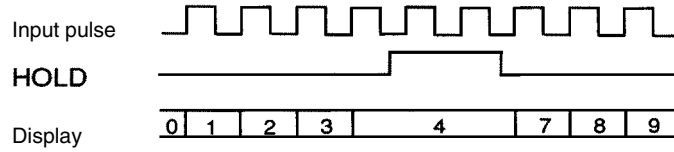

SECTION 6

Useful Functions

This section provides information on the output test and maintenance mode functions of the K3NR.

6-1	Teaching Function	108
6-1-1	Set Value	108
6-1-2	Prescaling Value	109
6-1-3	Linear Output Range	111
6-2	Output Test	112
6-3	Maintenance Mode	113
6-3-1	Maintenance Mode	113
6-3-2	Initialization	113

6-1 Teaching Function

- The K3NR is provided with a teaching function that can set an actual measured value as a set value without any front panel key input.

This function is useful for setting parameters while checking the operating status of the K3NR.

- The teaching function can be used to set the setting, prescaling values, and linear output range. The TEACH indicator will be lit if a parameter that can use the teaching function is displayed.

6-1-1 Set Value

- A setting value can be set with the actual input instead of key input in the setting mode.
- Follow the steps below to teach the setting value.

- 1, 2, 3...**
1. Press the RESET/TEACH Key for more than one second while the parameter is displayed. The process value will be displayed and the teaching indicator will flash.
 2. Press the RESET/TEACH Key again to retrieve the process value immediately before the key was pressed as a set value. The teaching indicator will be lit and the parameter will be displayed. Press the Escape Key to interrupt teaching.

SETTING EXAMPLE

Follow the steps described below to set the HH set value of bank 1 by using the teaching function.

Set Value LED Display Model Basic Model

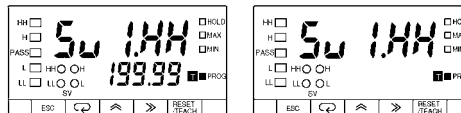

- 1, 2, 3...**
1. Press the RESET/TEACH Key for more than one second while the parameter is displayed. The process value will be displayed and the teaching indicator will flash.

Set Value LED Display Model Basic Model

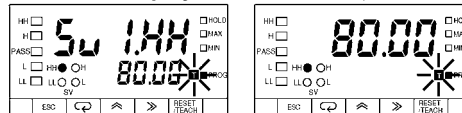

2. Press the RESET/TEACH Key again to retrieve the process value immediately before the key was pressed as a set value for changing. The teaching indicator will be lit and the parameter is displayed.

Set Value LED Display Model Basic Model

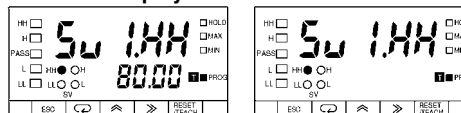

6-1-2 Prescaling Value

- A prescaling input value can be set using the actual measured value instead of key input in the prescaling menu.
- Input the process value as a reference value at the time of teaching.
- The prescaling value is calculated automatically by setting the present value displayed by the RESET/TEACH Key to an appropriate value.

If the process value is 50 at the time of teaching and the value to be displayed is 1, the prescaling value is obtained from the following.

$$\text{Value to be displayed/Process value} = 1/50 = 0.02$$

Therefore, X (mantissa) and Y (exponent) in the *P5LL* prescaling menu are set to 2 and -2 respectively.

- Follow the steps below to teach the setting value.
 - 1, 2, 3... 1. Press the RESET/TEACH Key for more than one second while the parameter is displayed. The process value will be displayed and the teaching indicator will flash.
 2. Press the RESET/TEACH Key again to change the present setting. Press the Up and Shift Keys to set the value to be displayed. Press the Escape Key to interrupt teaching.
 3. Press the RESET/TEACH Key again to set the prescaling value.

SETTING EXAMPLE

Follow the steps described below to use the teaching function to make the K3NR display 60 as 100.00.

Note In this example, all bank settings are disabled.

Set Value LED Display Model Basic Model

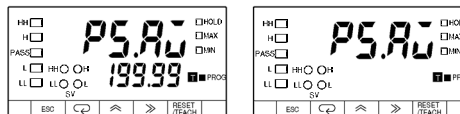

- 1, 2, 3... 1. Press the TEACH/RESET Key for more than one second while the parameter is displayed. The teaching indicator will flash.

Set Value LED Display Model Basic Model

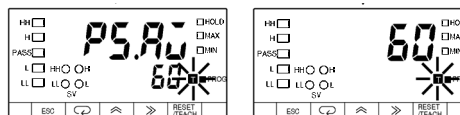

2. Press the RESET/TEACH Key again to change the present setting. Press the Up and Shift Keys to set the value to be displayed.

Set Value LED Display Model Basic Model

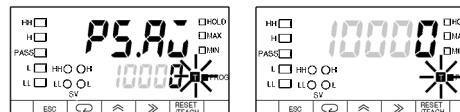

3. Press the RESET/TEACH Key again to set the prescaling value.

Set Value LED Display Model Basic Model

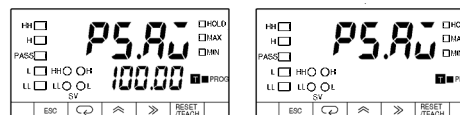

- Press the Mode Key to display the *PS.AY* prescaling value Y (exponent) of input A setting.

Note The asterisks indicate appropriate values.

Set Value LED Display Model Basic Model

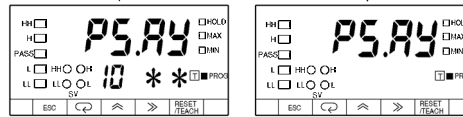

- Press the Mode Key to display the *dECP* decimal point position setting.

Set Value LED Display Model Basic Model

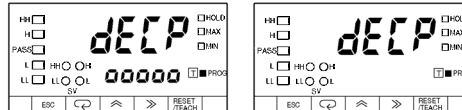

- Press the Shift Key to set *000.00*. The displayed setting will be validated automatically if no change is made for five seconds. The *dECP* decimal point position setting will be displayed again.

Set Value LED Display Model Basic Model

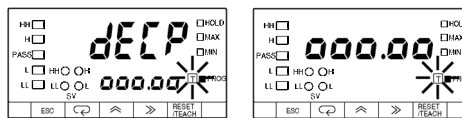

- Press the Escape Key to display the *PSCL* prescaling menu.

Set Value LED Display Model Basic Model

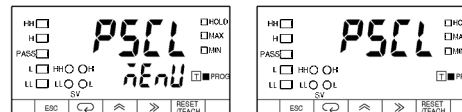

6-1-3 Linear Output Range

The teaching function can be also used to set the linear output range of the K3NR with the Linear Output Board.

- The H and L linear output ranges can be set using the actual measured value instead of key input in the option menu.
- Follow the steps below to teach the setting value.

- 1, 2, 3...**
1. Press the RESET/TEACH Key for more than one second while the parameter is displayed. The process value will be displayed and the teaching indicator will flash.
 2. Press the RESET/TEACH Key again to retrieve the process value immediately before the key was pressed as a set value. The teaching indicator will be lit and the parameter will be displayed. Press the Escape Key to interrupt teaching.

SETTING EXAMPLE

Follow the steps described below to set the H linear output range by using the teaching function.

Set Value LED Display Model Basic Model

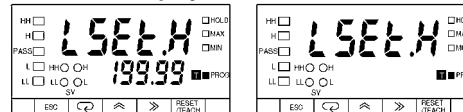

- 1, 2, 3...**
1. Press the RESET/TEACH Key for more than one second while the parameter is displayed. The process value will be displayed and the teaching indicator will flash.

Set Value LED Display Model Basic Model

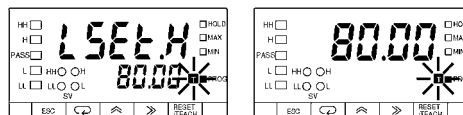

2. Press the RESET/TEACH Key again to retrieve the process value immediately before the key was pressed as a set value for changing. The teaching indicator will be lit and the parameter will be displayed. Press the Escape Key to interrupt teaching.

Set Value LED Display Model Basic Model

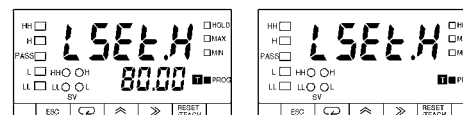

6-3 Maintenance Mode

The set values of the K3NR can be initialized in maintenance mode. The operations of the K3NR in this mode are described below.

6-3-1 Maintenance Mode

- The K3NR will be in maintenance mode if the Mode and Shift Keys are pressed simultaneously while the K3NR is turned on.
- The K3NR in maintenance mode will go into RUN mode if the Escape Key is pressed.

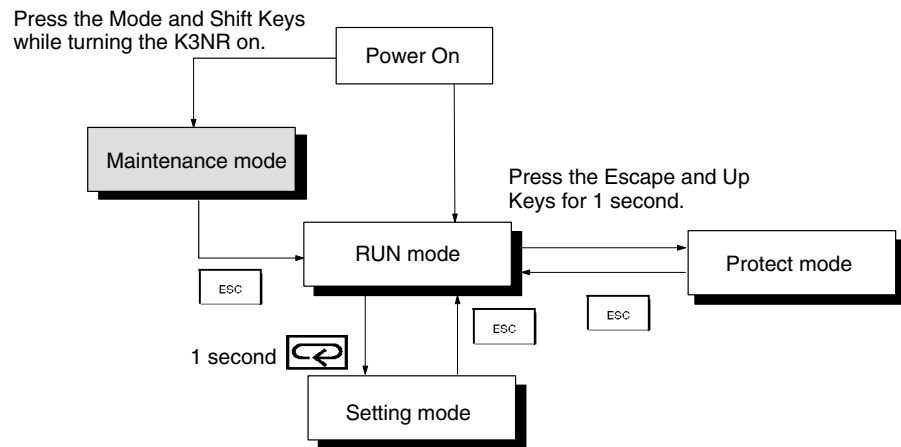

6-3-2 Initialization

Follow the steps described below to reset the set values of the K3NR to factory-set values.

- 1, 2, 3...
1. Press the Mode and Shift Keys simultaneously while turning the K3NR on. The $\bar{n}A\bar{n}t$ maintenance mode setting will be displayed.

Set Value LED Display Model Basic Model

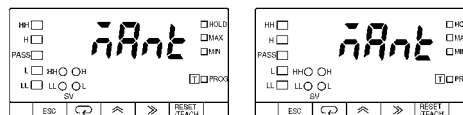

2. Press the Mode Key for more than one second. The $rE-\bar{L}n$ initialization setting will be displayed.

Set Value LED Display Model Basic Model



3. Press the Up Key to display $n\bar{o}$.

Set Value LED Display Model Basic Model

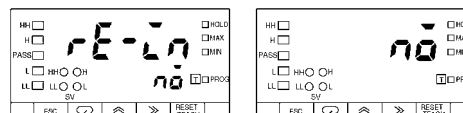

- 4. Press the Up Key to display *YES*. Press the Mode Key to initialize all set values. The K3NR will go into RUN mode.

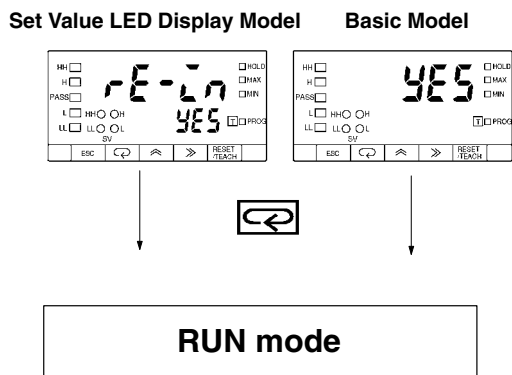

SECTION 7

BCD Output

This section provides information on the use of the K3NR with the BCD Output Board.

7-1	Connectors	116
7-2	Timing Charts	119

7-1 Connectors

Terminal Arrangement

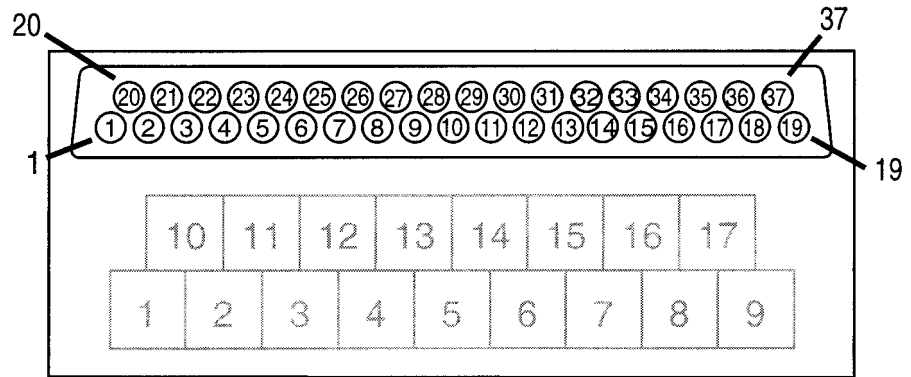

Terminal number	Signal name	Signal direction	Use
1	COM	---	GND:VO (See note 1.)
2	RD1-1	Output	1: Read data 10^0 digit
3	RD1-2	Output	2: Read data 10^0 digit
4	RD1-4	Output	4: Read data 10^0 digit
5	RD1-8	Output	8: Read data 10^0 digit
6	RD2-1	Output	1: Read data 10^1 digit
7	RD2-2	Output	2: Read data 10^1 digit
8	RD2-4	Output	4: Read data 10^1 digit
9	RD2-8	Output	8: Read data 10^1 digit
10	RD3-1	Output	1: Read data 10^2 digit
11	RD3-2	Output	2: Read data 10^2 digit
12	RD3-4	Output	4: Read data 10^2 digit
13	RD3-8	Output	8: Read data 10^2 digit
14	RD4-1	Output	1: Read data 10^3 digit
15	RD4-2	Output	2: Read data 10^3 digit
16	RD4-4	Output	4: Read data 10^3 digit
17	RD4-8	Output	8: Read data 10^3 digit
18	RD5-1	Output	1: Read data 10^4 digit
19	RD5-2	Output	2: Read data 10^4 digit
20	RD5-4	Output	4: Read data 10^4 digit
21	RD5-8	Output	8: Read data 10^4 digit
22	OVER	Output	Output when input value is not within the display range.
23	D - V	Output	Data confirmation signal
24	RUN	Output	Operation signal
25	COM	---	GND:VO (See note 1.)
26	REQ	Input	PV output request
27	MAX REQ	Input	Maximum value output request
28	MIN REQ	Input	Minimum value output request
29	HOLD	Input	Hold input
30	RESET	Input	Reset input
31	POL	Output	Positive/Negative polarity signal
32	HH	Output	HH output (See note 2.)
33	H	Output	H output (See note 2.)
34	PASS	Output	PASS output (See note 2.)
35	L	Output	L output (See note 2.)

Terminal number	Signal name	Signal direction	Use
36	LL	Output	LL output (See note 2.)
37	COM	Output	GND:VO (See note 1.)

- Note**
1. Terminals 1, 25, and 37 have the same COM.
 2. Refer to *2-3 Output Board* for comparative outputs.

Applicable Connectors

Use the connector provided with the K3NR or an equivalent connector for the cable connecting to the BCD output connector.

The following connectors are provided with the K3NR.

Plug: XM2A-3701 (OMRON)

Hood: XM2S-3711 (OMRON)

The depth required for the installation of the K3NR is 200 mm min. in consideration of the space required by the cable.

Connecting Conditions

Refer to the following for the connecting conditions of each I/O. Refer to *2-3 Output Block* for output signals HH through LL.

- Input

Input current with no voltage input: 10 mA

Signal level

ON voltage: 1.5 V max.

OFF voltage: 3 V min.

- Output

Rated load voltage: 24 VDC

Rated load current: 10 mA

Current leakage: 10 μ A max.

Connection Example

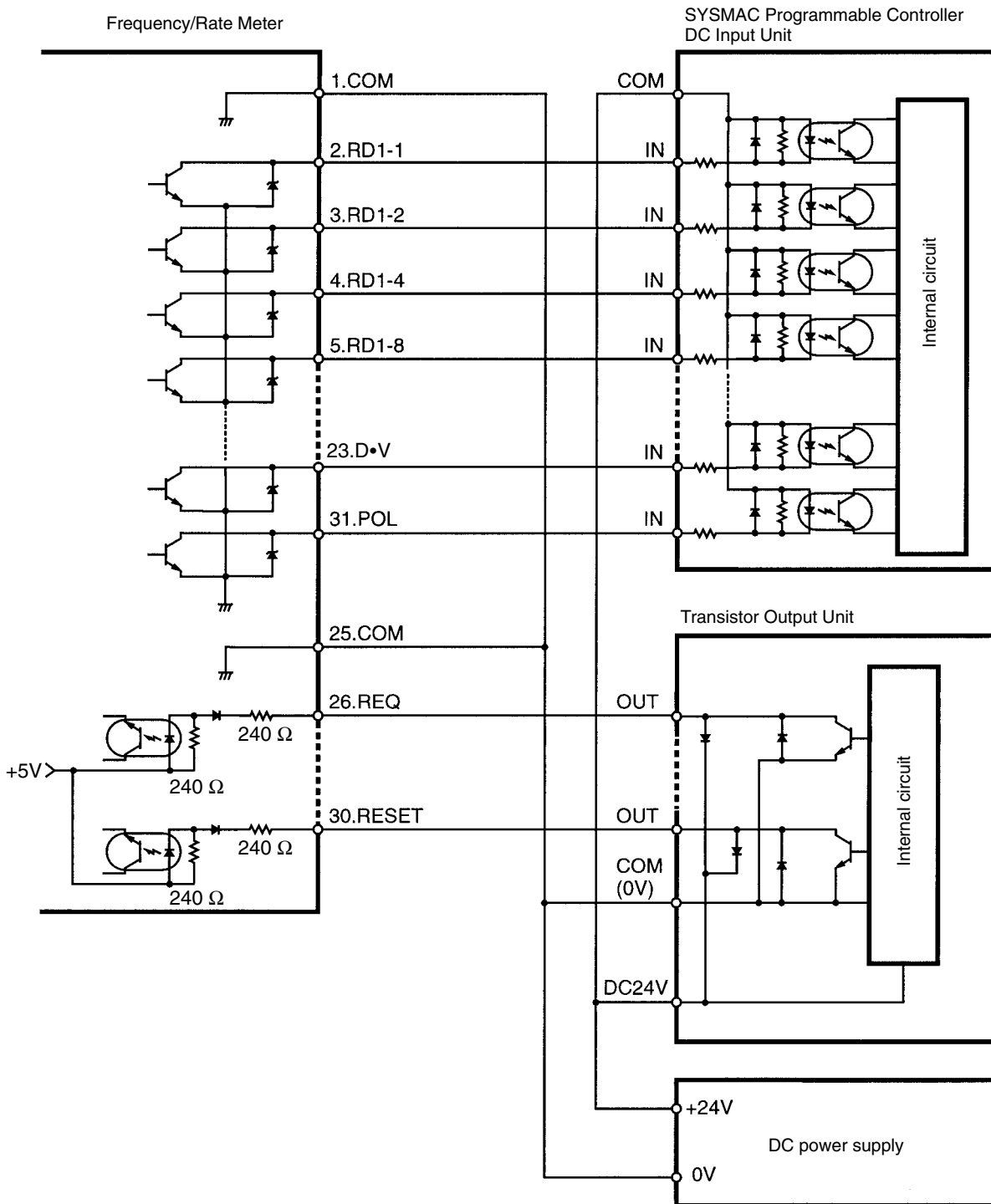

- Note**
1. Connect RD2-1 through RD2-4, RD3-1 through RD3-4, RD4-1 through RD4-4, and RD5-1 through RD5-4 in the same way as RD1-1 through RD1-4.
 2. Connect the RUN and OVER signals if they are used as status data.

Signals

When the HOLD signal is ON, the measurement operation stops and the process value input effective immediately before the HOLD signal is retained.

When the RESET signal is ON, the maximum and minimum values are set to the process value.

The OVER signal is ON when the input value is not within the display range.

The process value is output when the MAXREQ or MINREQ signal is ON at the time the output is tested in output test.

Multiple input signals must not turn ON. If multiple input signals turn ON or a single signal input is combined with another signal input, all output data will be turned OFF.

7-2 Timing Charts

When a REQ signal is input from a Programmable Controller to the K3NR in RUN or output test, the K3NR outputs a DATA VALID (D•V) signal. In other cases, the K3NR has All Signals OFF (H) output.

Refer to the following for the timing of each signal.

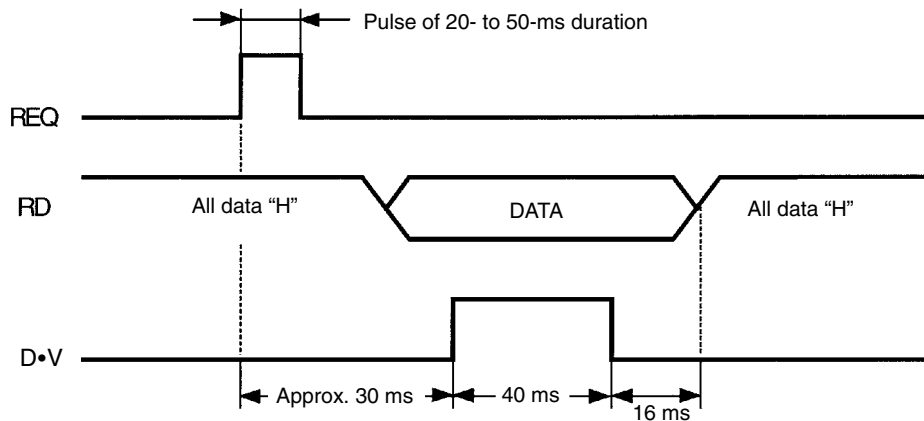

The REQ signal must be kept ON as shown below if the K3NR has continuous data output.

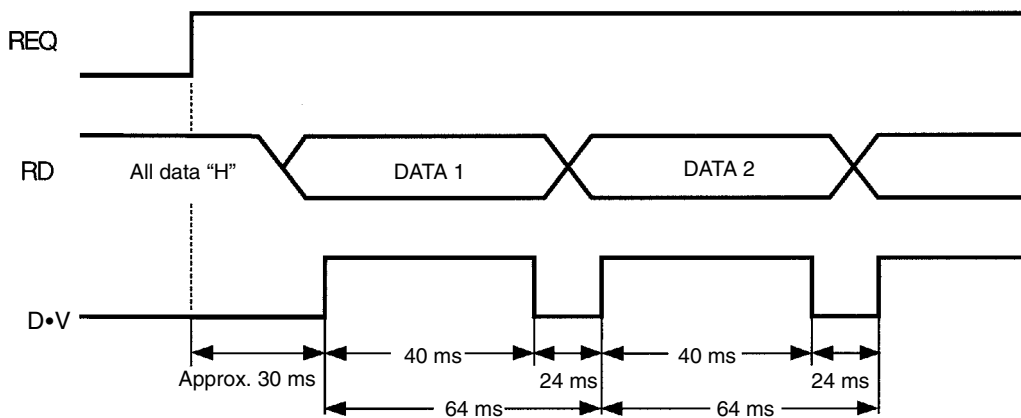

The polarity of the data must be checked with a POLARITY signal. The polarity is positive when the POLARITY signal is OFF and negative when the POLARITY signal is ON.

The K3NR in output test has test data output regardless of the type of REQ signal.

Operating Conditions

The RUN signal is turned ON in RUN or output test. The RUN signal is, however, turned OFF when an error other than overflow results.

Do not input multiple signals, otherwise all output data will be turned OFF.

SECTION 8

Troubleshooting

This section provides information for troubleshooting the K3NR.

8-1	Items to Be Checked First	122
8-2	Display	122
8-2-1	Flashing	122
8-2-2	Error Message	122

8-1 Items to Be Checked First

First, check the following three items if the K3NR has any problems during operation.

- 1, 2, 3...
1. **Power Supply**
Be sure that power supplied to the K3NR is within the rated voltage range.
 2. **Wiring**
Be sure that the K3NR is wired correctly.
 3. **Communications Conditions**
If the model is a K3NR with the Communications Output Board, be sure that the baud rate and unit numbers are correct.

After checking and remedying the above items, if the K3NR still has problems during operation, check the error message.

8-2 Display

8-2-1 Flashing

The display will flash in the following cases.

- The input or process value is not within the display range.
If the display flashes the output status will be as follows:
Models with BCD Output Board: The OVER signal will be ON.
Models with Communications Output Board: The OVER or UNDER signal will be ON and other output signals will be retained.
- The display will flash for three seconds if an attempt is made to change a setting on the K3NR. Set to remote programming to accept key input.

8-2-2 Error Message

The error condition can be checked with the error message.

The K3NR will have the following output statuses when an error message is displayed.

- HH, H, PASS, L, and LL will all be OFF.
- Linear output will be limited to the minimum value.
- The type of BCD output will be All Outputs OFF (H).
- The Unit error response will be returned from the model with a communications function.

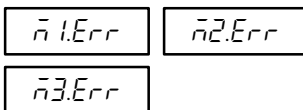

Memory Error

Meaning of Error

The internal memory has an error.

Remedy

Turn the K3NR off and on. If the memory error still exists, the K3NR will need to be repaired. If the K3NR returns to normal operation, the K3NR may have been affected by noise. Check if there is any source of noise generation near the K3NR.



Output Error

Meaning of Error

The internal circuit has an error.

Remedy

Turn the K3NR off and on. If the output error still exists, the K3NR will need to be repaired.

Notice

When the power is turned ON for the first time after a separately purchased Output Unit is mounted to the K3N□, the following messages will be displayed. Follow the procedures below to clear the messages.

EHG-ō

Meaning of Message:

This message is displayed when the power is turned ON after an Output Unit is mounted or replaced.

It is also displayed when there is an error in the internal circuitry.

Remedy:

Press the Mode Key for less than 1 second. The K3N□ should enter RUN mode. In this case, a malfunction has not occurred.

If *EHG-ō* continues to be displayed, turn the power OFF and ON again. If the K3N□ still fails to enter RUN mode, repairs are necessary. It is possible that noise has caused faulty operation.

Err-ō

Meaning of Message:

This message will be displayed when the power is turned ON and either an incompatible Output Unit has been mounted on the K3N□ or an Output Unit has not been mounted on the K3N□ with set value LED display.

It is also displayed when there is an error in the internal circuitry.

Remedy:

Check that the Output Unit is compatible, and if it is not, turn OFF the power and replace it with a compatible one. If an Output Unit is not mounted on the K3N□ with set value LED display, turn OFF the power and mount a compatible Unit.

When the power is turned ON again, *EHG-ō* will be displayed. If the Mode Key is pressed for less than 1 second, the K3N□ should enter RUN mode. In this case, a malfunction has not occurred.

If *Err-ō* or *EHG-ō* is still displayed, turn the power OFF and ON again. If the K3N□ still fails to enter RUN mode, repairs are necessary. It is possible that noise has caused faulty operation.

Appendix A

Specifications

Ratings

Supply voltage	100 to 240 VAC (50/60 Hz); 12 to 24 VDC
Operating voltage range	85% to 110% of supply voltage
Power consumption (see note)	15 VA max. (max. AC load with all indicators lit) 10 W max. (max. DC load with all indicators lit) (see note)
Sensor power supply	80 mA at 12 VDC±10%
Insulation resistance	20 MΩ min. (at 500 VDC) between external terminal and case. Insulation provided between inputs, outputs, and power supply.
Dielectric withstand voltage	2,000 VAC for 1 min between external terminal and case. Insulation provided between inputs, outputs, and power supply.
Noise immunity	±1,500 V on power supply terminals in normal or common mode ±1 μs, 100 ns for square-wave noise with 1 ns
Vibration resistance	Malfunction: 10 to 55 Hz, 0.5-mm for 10 min each in X, Y, and Z directions Destruction: 10 to 55 Hz, 0.75-mm for 2 hrs each in X, Y, and Z directions
Shock resistance	Malfunction: 98 m/s ² (10G) for 3 times each in X, Y, and Z directions Destruction: 294 m/s ² (30G) for 3 times each in X, Y, and Z directions
Ambient temperature	Operating: -10°C to 55°C (with no icing) Storage: -20°C to 65°C (with no icing)
Ambient humidity	Operating: 25% to 85% (with no condensation)
Ambient atmosphere	Must be free of corrosive gas
EMC	Emission Enclosure: EN55011 Group 1 class A Emission AC Mains: EN55011 Group 1 class A Immunity ESD: EN61000-4-2: 4-kV contact discharge (level 2) 8-kV air discharge (level 3) Immunity-RF-interference: ENV50140: 10 V/m (amplitude modulated, 80 MHz to 1 GHz) (level 3) 10 V/m (pulse modulated, 900 MHz) Immunity Conducted Disturbance: ENV50141: 10 V (0.15 to 80 MHz) (level 3) Immunity Burst: EN61000-4-4: 2-kV power-line (level 3) 2-kV I/O signal-line (level 4)
Approved standards	UL508, CSA22.2; conforms to EN50081-2, EN50082-2, EN61010-1 (IEC61010-1); conforms to VDE106/part 100 (Finger Protection) when the terminal cover is mounted.
Weight	Approx. 400 g

Note An Intelligent Signal Processor with DC supply voltage requires approximately 1 A DC as control power supply current the moment the Intelligent Signal Processor is turned on. Do not forget to take this into consideration when using several Intelligent Signal Processors. When the Intelligent Signal Processor is not in measuring operation (e.g., the Intelligent Signal Processor has been just turned on or is operating for start-up compensation time), the display will read “00000” and all outputs will be OFF.

Input/Output Ratings

Relay Contact Output

(Incorporating a G6B Relay)

Item	Resistive load ($\cos\phi = 1$)	Inductive load ($\cos\phi = 0.4$, $L/R = 7$ ms)
Rated load	5 A at 250 VAC; 5 A at 30 VDC	1.5 A at 250 VAC, 1.5 A at 30 VDC
Rated carry current	5 A max. (at COM terminal)	
Max. contact voltage	380 VAC, 125 VDC	
Max. contact current	5 A max. (at COM terminal)	
Max. switching capacity	1,250 VA, 150 W	375 VA, 80 W
Min. permissible load (P level, reference value)	10 mA at 5 VDC	
Mechanical life	50,000,000 times min. (at a switching frequency of 18,000 times/hr)	
Electrical life (at an ambient temperature of 23°C)	100,000 times min. (at a rated load switching frequency of 1,800 times/hr)	

Transistor Output

Rated load voltage	24 VDC max.
Max. load current	50 mA
Leakage current	100 μ A max.

BCD Output

I/O signal name		Item	Rating
Inputs	REQUEST, HOLD, MAX, MIN, RESET	Input signal	No-voltage contact input
		Input current with no-voltage input	10 mA
		Signal level	ON voltage: 1.5 V max. OFF voltage: 3 V min.
Outputs	DATA, POLARITY, OVERFLOW, DATA VALID, RUN	Rated load voltage	24 VDC max.
		Max. load current	10 mA
		Leakage current	100 μ A max.

Note Logic method: negative logic

Linear Output

Item	4 to 20 mA	1 to 5 V	1 mV/10 digits (see note)
Resolution	4,096		
Output error	$\pm 0.5\%$ FS		$\pm 1.5\%$ FS
Permissible load resistance	600 Ω max.	500 Ω min.	1 K Ω min.

Note For the 1 mV/10-digit output, the output voltage changes for every 40 to 50 increment in the display value.

Communications

Item		RS-232C, RS-422	RS-485
Transmission method		4-wire, half-duplex	2-wire, half-duplex
Synchronization method		Start-stop synchronization	
Baud rate		1,200/2,400/4,800/9,600/19,200/38,400 bps	
Transmission code		ASCII (7-bit)	
Communications	Write to K3NR	Comparative set value, prescaling value, remote/local programming, reset control of maximum/minimum values, and other setting mode items excluding communications conditions.	
	Read from K3NR	Process value, comparative set value, maximum value, minimum value, model data, error code, and others	

For details, refer to *Communication Operation Manual*.

Characteristics

Input signal	No-voltage contact (30 Hz max., ON/OFF pulse width: 15 ms min.) Voltage pulse (50 kHz max., ON/OFF pulse width: 9 μ s min., ON voltage: 4.5 to 30 V/OFF voltage: -30 to 2 V) Open collector (50 kHz max., ON/OFF pulse width: 9 μ s min.) Connectable Sensors ON residual voltage: 3 V max. OFF leakage current: 1.5 mA max. Load current: Must have switching capacity of 20 mA min. Must be able to dependably switch a load current of 5 mA max.
Measuring accuracy (at 23\pm5$^{\circ}$C)	Operating modes 1 and 6: $\pm 0.006\%$ rdg ± 1 digit Operating modes 2 to 5: $\pm 0.02\%$ rdg ± 1 digit
Measuring modes and ranges (Operating modes 1 to 6 are for no-contact sensor models)	Operating mode 1: Rotational/circumferential speed 0.0005 to 50,000 Hz Operating mode 2: Absolute ratio 0.0005 to 50,000 Hz Operating mode 3: Error ratio 0.0005 to 50,000 Hz Operating mode 4: Rotational difference 0.0005 to 50,000 Hz Operating mode 5: Flow rate ratio 0.0005 to 50,000 Hz Operating mode 6: Passing time 0.0005 to 50,000 Hz Operating mode 7: Pulse counting 0 to 4G count (32-bit counter)
Max. displayed digits	5 digits (-19999 to 99999)
Display	7-segment LED
Polarity display	"-" is displayed automatically with a negative input signal.
Zero display	Leading zeros are not displayed.
Prescale function	Programming via front-panel key inputs. (0.0001 x 10 ⁻⁹ to 9.9999 x 10 ⁹ , decimal point can be set freely) Can be set using prescale value teaching.
HOLD functions (see note 2)	Max. value (peak) hold, Min. value (bottom) hold
External control	HOLD (Process value held) RESET (Maximum/minimum data reset, counting value reset) BANK (Selection of one bank out of 4 banks of set values) (Selection of one bank out of 4 banks of prescale values)
Comparative output hysteresis setting	Programmable with front-panel key inputs (1 to 9999).
Other functions	Variable linear output range (for models with linear outputs only) Remote/Local processing (available for communications output models only) Maximum/Minimum value data reset with front panel keys Comparative output pattern selection Process time for averaging measured values Startup compensation time (0.0 to 99.9 s) Time unit display Security Memory power failure
Output configuration	Relay contact output (5 outputs) Transistor output (NPN and PNP open collector), BCD (NPN open collector) Parallel BCD (NPN open collector) + transistor output (NPN open collector) Linear output (4 to 20 mA, 1 to 5 V) + transistor output (NPN open collector) Communication functions (RS-232C, RS-485, RS-422) Communication functions (RS-232C, RS-485, RS-422) + transistor output (NPN open collector)
Delay in comparative outputs (at transistor output)	Operating modes 1 to 6: 200 ms max. Operating mode 7: 1 ms max.
Enclosure rating	Front panel: NEMA4X for indoor use (equivalent to IP66) Rear case: IEC standard IP20 Terminals: IEC standard IP00
Memory protection	Non-volatile memory (EEPROM) (possible to rewrite 100,000 times)

- Note**
1. The linear output range cannot be set when connected to a 1 mV/10-digit Linear Output Board.
 2. Not effective for operating mode 7.

Appendix B

Estimated Frequency Calculation

If input pulses are suddenly interrupted, the estimated frequency calculation function continuously estimates the frequency in preparation for the next pulse that may occur. This function ensures improved response to any pulse occurring within the time period represented by the shaded area of the accompanying graph.

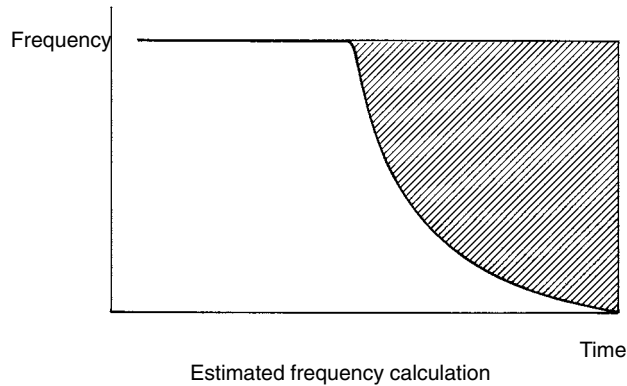

Estimated frequency calculation graph:

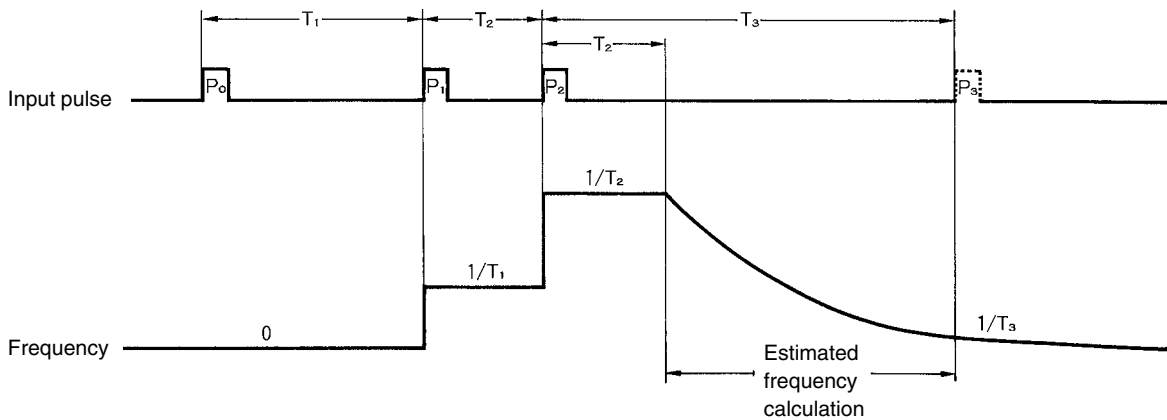

The input frequency cannot be calculated with pulse P0 only. Therefore, the result remains 0. With pulse P1, T_1 (from P0 to P1) is measured as one cycle, and the input frequency is calculated from $1/T_1$. With pulse P2, if T_1 is larger than T_2 (if the input frequency increases, i.e. the cycle is shorter), $1/T_2$ is adopted as the input frequency at that moment. If no pulse is detected for the T_2 period after P2, the new input frequency cannot be known until the next pulse is detected. The estimated value is $1/T_3$ if no pulse is detected for period T_3 . If P3 is detected at that time, the input frequency then is $1/T_3$. Therefore the K3NR produces a fast and accurate response as a result of its estimate. It is better to estimate the input frequency than to keep the frequency, $1/T_2$, until pulse P3 is actually detected. With this function, the K3NR can react to sudden changes in the input frequency.

Appendix C

List of Settings



Use this sheet to keep a record of set values.

Menu	Parameter	Setting range	Set value
5u5Et Setting value menu	5.bAnP	Bank no. of set value (1 to 4) to be changed	
	5u*.HH	HH set value (- 19999 to 99999)	
	5u*. H	H set value (- 19999 to 99999)	
	5u*. L	L set value (- 19999 to 99999)	
	5u*.LL	LL set value (- 19999 to 99999)	
P5CL Prescaling menu	P.bAnP	Bank no. of prescale (OFF/ 1 to 4) to be changed	
	P5*.Aū	Prescaling value X (mantissa) of input A (0.000 1 to 9.9999)	
	P5*.AY	Prescaling value Y (exponent) of input A (-9 to 09)	
	P5*.bū	Prescaling value X (mantissa) of input B (0.000 1 to 9.9999)	
	P5*.bY	Prescaling value Y (exponent) of input B (-9 to 09)	
	dECP.*	Decimal point position (00000/0.0000/00.000/000.00/0000.0)	
SEtUP Setup menu	FUnC	Operating mode (F 1 to F 7)	
	ūnR/ūnb	Sensor type (00, 0 1, 10, 1 1)	
	Ērō.Aū	Automatic zero time X (mantissa) of input A (0.000 1 to 9.9999)	
	Ērō.AY	Auto zero time Y (exponent) of input A (-9 to 09)	
	Ērō.bū	Auto zero time X (mantissa) of input B (0.000 1 to 9.9999)	
	Ērō.bY	Auto zero time Y (exponent) of input B (-9 to 09)	
	tūnE	Time unit SCAL (-19999 to 99999) SEC (0 to 99999 s) ūn (0 to 99999 min) H.ūū.55 (hours, minutes, seconds) ūū.55.d (minutes, seconds, 1/100 s)	
	U-nō	Communications unit no. (00 to 99)	
	bPS	Baud rate (1200/2400/4800/9600/ 19200/38400)	
	LEn	Word length (7/8)	
	5bū	Stop bits (1/2)	
	PrēY	Parity bits (nōnE: None; EūEn: Even; ōdd: Odd)	
	ōPt Option menu	Aūū	Process time for averaging measured value FRSt (60 ms) 0.5 (500 ms) 1 (1 s) 2 (2 s) 4 (4 s) 8 (8 s) 16 (16 s)
5tūnE		Startup compensation time (0 to 99.9)	
ūEūō		Power failure memory (enabled/disabled)	
HYS		Hysteresis (000 1 to 9999)	
E-ōū		Output pattern nōūRL (Standard output) ĒōnE (Zone output) LEūEL (Level output)	
LSEt.H		H linear output range (- 19999 to 99999)	
LSEt.L		L linear output range (- 19999 to 99999)	
r-L		Remote/Local programming (rūē: Remote; LLL: Local)	

Note The selected bank number will be displayed where an asterisk (*) appears.

Appendix D Available Models

Base Units

Input type	NPN/Voltage pulse		PNP	
	100 to 240 VAC	12 to 24 VDC	100 to 240 VAC	12 to 24 VDC
Basic Models These models provide a present value LED and front-panel control keys. Can be connected to any Output Board, or can be used for display only without an Output Board. 	K3NR-NB1A	K3NR-NB2A	K3NR-PB1A	K3NR-PB2A
Set Value LED Models These models provide a present value LED, set value LED, and front-panel control keys. Can be connected to Relay, Transistor, or Combination Output Boards. 	K3NR-NB1C	K3NR-NB2C	K3NR-PB1C	K3NR-PB2C

Available Output Board Combinations

Output type	Output configuration	Output boards	Base units	
			Basic	Set Value LED Display
Relay contact	3 outputs: H, PASS, L (SPDT)	K31-C1	Yes	Yes
	5 outputs: HH, H, L, LL (SPST-NO), and PASS (SPDT)	K31-C2	Yes	Yes
	5 outputs: HH, H, L, LL (SPST-NC), and PASS (SPDT)	K31-C5	Yes	Yes
Transistor	5 outputs (NPN open collector)	K31-T1	Yes	Yes
	5 outputs (PNP open collector)	K31-T2	Yes	Yes
BCD (see note)	5-digit output (NPN open collector)	K31-B2	Yes	---
Linear	4 to 20 mA DC	K31-L1	Yes	---
	1 to 5 VDC	K31-L2	Yes	---
	1 mV/10 digits	K31-L3	Yes	---
	0 to 5 VDC	K31-L7	Yes	---
	0 to 10 VDC	K31-L8	Yes	---
Communication boards (see note)	RS-232C	K31-FLK1	Yes	---
	RS-485	K31-FLK2	Yes	---
	RS-422	K31-FLK3	Yes	---
Combination output and communication boards	BCD output + 5 transistor outputs (NPN open collector)	K31-B4	Yes	Yes
	4 to 20 mA + 5 transistor outputs (NPN open collector)	K31-L4	Yes	Yes
	1 to 5 V + 5 transistor outputs (NPN open collector)	K31-L5	Yes	Yes
	1 mV/10 digits + 5 transistor outputs (NPN open collector)	K31-L6	Yes	Yes
	0 to 5 VDC + 5 transistor outputs (NPN open collector)	K31-L9	Yes	Yes
	0 to 10 VDC + 5 transistor outputs (NPN open collector)	K31-L10	Yes	Yes
	RS-232C + 5 transistor outputs (NPN open collector)	K31-FLK4	Yes	Yes
	RS-485 + 5 transistor outputs (NPN open collector)	K31-FLK5	Yes	Yes
RS-422 + 5 transistor outputs (NPN open collector)	K31-FLK6	Yes	Yes	

Note For details, refer to the *Communication Operation Manual*.

Model Number Legend

Base Units and Output Boards can be ordered individually or as sets. Refer to the *Output Board Combinations* table on page 133.

Base Units

K3NR -
 1 2 3 4

Output Boards

K31 -
 5 6 7 8

Base Units with Output Boards

K3NR - -
 1 2 3 4 5 6 7 8

1, 2. Input Sensors Codes

NB: NPN inputs

PB: PNP inputs

3. Supply Voltage

1: 100 to 240 VAC

2: 12 to 24 VDC

4. Display

A: Basic

C: Set Value LED Display

5, 6, 7, 8. Output Type Codes

C1: 3 comparative relay contact outputs (H, PASS, L: SPDT)

C2: 5 comparative relay contact outputs (HH, H, L, LL: SPST-NO; PASS: SPDT)

C5: 5 comparative relay contact outputs (HH, H, L, LL: SPST-NC; PASS: SPDT)

T1: 5 comparative transistor outputs (NPN open collector)

T2: 5 comparative transistor outputs (PNP open collector)

B2: BCD output (NPN open collector) (see note)

B4: BCD output + 5 transistor outputs (NPN open collector)

L1: Linear output (4 to 20 mA) (see note)

L2: Linear output (1 to 5 VDC) (see note)

L3: Linear output (1 mV/10 digits) (see note)

L4: Linear output, 4 to 20 mA + 5 transistor outputs (NPN open collector)

L5: Linear output, 1 to 5 V + 5 transistor outputs (NPN open collector)

L6: Linear output, 1 mV/10 digits+ 5 transistor outputs (NPN open collector)

L7: Linear output, 0 to 5 VDC (see note)

L8: Linear output, 0 to 10 VDC (see note)

L9: Linear output, 0 to 5 VDC + 5 transistor outputs (NPN open collector)

L10: Linear output, 0 to 10 VDC + 5 transistor outputs (NPN open collector)

FLK1: Communication RS-232C (see note)

FLK2: Communication RS-485 (see note)

FLK3: Communication RS-422 (see note)

FLK4: RS-232C + 5 transistor outputs (NPN open collector)

FLK5: RS-485 + 5 transistor outputs (NPN open collector)

FLK6: RS-422 + 5 transistor outputs (NPN open collector)

Note These output types are available on Basic Models only.

Appendix E

Available Parameters

Available parameters vary with the output board of the K3NR and are indicated as “YES” in the following table.

K3NR-□B□A Basic Model

Menu	Parameter	Output board							
		No output	C1/C2/ C5/T1/T2 (note 2)	B2	B4	L1/L2/ L3/L7/ L8	L4/L5/ L6/L9/ L10	FLK1/ FLK2/ FLK3	FLK4/ FLK5/ FLK6
S _u SEt Setting value menu	S _b RnP Bank no. of set value		YES		YES		YES		YES
	S _u *.HH HH set value		YES		YES		YES		YES
	S _u *. H H set value		YES		YES		YES		YES
	S _u *. L L set value		YES		YES		YES		YES
	S _u *.LL LL set value		YES		YES		YES		YES
P5CL Prescal- ing menu	P _b RnP Bank no. of prescale	YES	YES	YES	YES	YES	YES	YES	YES
	P5*.R _X Prescaling value X (mantissa) of input A	YES	YES	YES	YES	YES	YES	YES	YES
	P5*.R _Y Prescaling value Y (exponent) of input A	YES	YES	YES	YES	YES	YES	YES	YES
	P5*.b _X Prescaling value X (mantissa) of input B	YES	YES	YES	YES	YES	YES	YES	YES
	P5*.b _Y Prescaling value Y (exponent) of input B	YES	YES	YES	YES	YES	YES	YES	YES
	dECP.* Decimal point position	YES	YES	YES	YES	YES	YES	YES	YES
SEtUP Setup menu	FUnE Operating mode	YES	YES	YES	YES	YES	YES	YES	YES
	CnA/Cnb Sensor type	YES	YES	YES	YES	YES	YES	YES	YES
	E _r o.R _X Auto zero time X (mantissa) of input A	YES	YES	YES	YES	YES	YES	YES	YES
	E _r o.R _Y Auto zero time Y (exponent) of input A	YES	YES	YES	YES	YES	YES	YES	YES
	E _r o.b _X Auto zero time X (mantissa) of input B	YES	YES	YES	YES	YES	YES	YES	YES
	E _r o.b _Y Auto zero time Y (exponent) of input B	YES	YES	YES	YES	YES	YES	YES	YES
	tUnE Time unit	YES	YES	YES	YES	YES	YES	YES	YES
	U-n _o Communications unit no.							YES	YES
	bPS Baud rate							YES	YES
	LEn Word length							YES	YES
	Sbct Stop bits							YES	YES
	PrtY Parity bits							YES	YES
oPt Option menu	RuG Process time for averaging measured value	YES	YES	YES	YES	YES	YES	YES	YES
	StcnE Startup compensation time	YES	YES	YES	YES	YES	YES	YES	YES
	nEn _o Power failure memory	YES	YES	YES	YES	YES	YES	YES	YES
	HYS Hysteresis		YES		YES		YES		YES
	E-oUt Output pattern		YES		YES		YES		YES
	LSEt.H H linear output range					YES (note 1)	YES (note 1)		
	LSEt.L L linear output range					YES (note 1)	YES (note 1)		
r-L Remote/Local programming							YES	YES	

Menu	Parameter	Output board							
		No output	C1/C2/C5/T1/T2 (note 2)	B2	B4	L1/L2/L3/L7/L8	L4/L5/L6/L9/L10	FLK1/FLK2/FLK3	FLK4/FLK5/FLK6
Protect menu	<i>Prōt</i> All key protect		YES	YES	YES	YES	YES	YES	YES
	<i>SuSEt</i> Set value change prohibit		YES		YES		YES		YES
	<i>rESEt</i> Counting value reset prohibit	YES	YES	YES	YES	YES	YES	YES	YES
	<i>ññ.rSt</i> Maximum/Minimum value clear prohibit	YES	YES	YES	YES	YES	YES	YES	YES
	<i>SEEr</i> Security	YES	YES	YES	YES	YES	YES	YES	YES

- Note**
1. The linear output range cannot be set with the K31-L3 and K31-L6 Output Boards.
 2. The HH and LL set values cannot be set with the K31-C1.
 3. The selected bank number will be displayed where an asterisk (*) appears.

K3NR-□B□C Set Value LED Display Model

Menu	Parameter	Output board			
		C1/C2/C5/T1/T2 (note 2)	B4	L4/L5/L6/L9/L10	FLK4/FLK5/FLK6
<i>SuSEt</i> Setting value menu	<i>S.bRnP</i> Bank no. of set value	YES	YES	YES	YES
	<i>Su.HH</i> HH set value	YES	YES	YES	YES
	<i>Su.H</i> H set value	YES	YES	YES	YES
	<i>Su.L</i> L set value	YES	YES	YES	YES
	<i>Su.LL</i> LL set value	YES	YES	YES	YES
<i>PSEL</i> Prescaling menu	<i>P.bRnP</i> Bank no. of prescale	YES	YES	YES	YES
	<i>P5*.Rū</i> Prescaling value X (mantissa) of input A	YES	YES	YES	YES
	<i>P5*.RY</i> Prescaling value Y (exponent) of input A	YES	YES	YES	YES
	<i>P5*.bū</i> Prescaling value X (mantissa) of input B	YES	YES	YES	YES
	<i>P5*.bY</i> Prescaling value Y (exponent) of input B	YES	YES	YES	YES
	<i>dECP.*</i> Decimal point position	YES	YES	YES	YES
<i>SETUP</i> Setup menu	<i>FUnC</i> Operating mode	YES	YES	YES	YES
	<i>ĀnR/Ānb</i> Sensor type	YES	YES	YES	YES
	<i>Ērā.Rū</i> Auto zero time X (mantissa) of input A	YES	YES	YES	YES
	<i>Ērā.RY</i> Auto zero time Y (exponent) of input A	YES	YES	YES	YES
	<i>Ērā.bū</i> Auto zero time X (mantissa) of input B	YES	YES	YES	YES
	<i>Ērā.bY</i> Auto zero time Y (exponent) of input B	YES	YES	YES	YES
	<i>tĀnE</i> Time unit	YES	YES	YES	YES
	<i>U-nā</i> Communications unit no.				YES
	<i>bPS</i> Baud rate				YES
	<i>LEn</i> Word length				YES
	<i>SbĀt</i> Stop bits				YES
<i>PrĀY</i> Parity bits				YES	

Menu	Parameter	Output board			
		C1/C2/C5/ T1/T2 (note 2)	B4	L4/L5/ L6/L9/ L10	FLK4/ FLK5/ FLK6
<i>ōPŁ</i> Option menu	<i>RŁŁ</i> Process time for averaging measured value	YES	YES	YES	YES
	<i>ŚŁŁŁŁ</i> Startup compensation time	YES	YES	YES	YES
	<i>ŃŁŁŁ</i> Power failure memory	YES	YES	YES	YES
	<i>HYS</i> Hysteresis	YES	YES	YES	YES
	<i>Ł-ōŁŁ</i> Output pattern	YES	YES	YES	YES
	<i>ŁŚŁŁ.H</i> H linear output range			YES (note 1)	
	<i>ŁŚŁŁ.L</i> L linear output range			YES (note 1)	
	<i>r-L</i> Remote/Local programming				YES
<i>PŁŁŁ</i> Protect menu	<i>RLL</i> All key protect	YES	YES	YES	YES
	<i>ŚŁŚŁŁ</i> Set value change prohibit	YES	YES	YES	YES
	<i>rĒŚŁŁ</i> Counting value reset prohibit	YES	YES	YES	YES
	<i>ŃŃ.rŚŁ</i> Maximum/Minimum value clear prohibit	YES	YES	YES	YES
	<i>ŚĒŁ</i> Security	YES	YES	YES	YES

- Note**
1. The linear output range cannot be set with the K31-L6 Output Board.
 2. The HH and LL set values cannot be set with the K31-C1.
 3. The selected bank number will be displayed where an asterisk (*) appears.

Appendix F

Setting Examples

In the following example, with the K3NR, rotations (rpm) can be displayed using a rotary encoder that has 1,000 output pulses per revolution on condition that the prescaling bank is set to OFF, and the prescaling value is set to $1/1,000 = 0.001 = 1 \times 10^{-3}$.

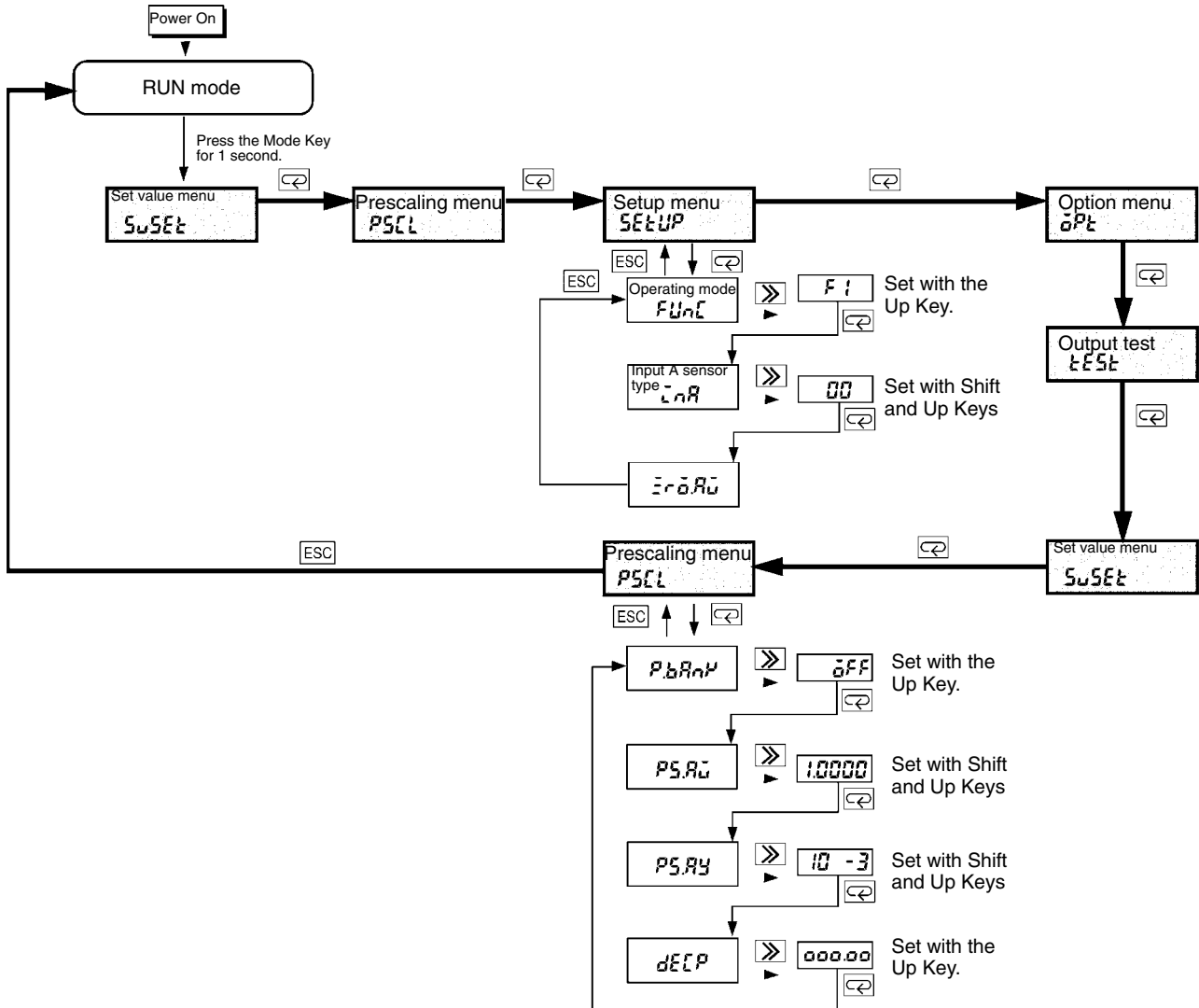

- Note**
1. If the operating mode setting is changed, all the other parameters are set to default values except those for the communications and settings in protect mode. Therefore, set the operating mode first.
 2. The displayed setting will be validated automatically if no change is made for five seconds and the next parameter will be displayed.

Index

A

- absolute ratio, 25
 - operating mode setting, 58
- All Key Protect, setting, 90
- auto-zero time
 - description, 3
 - setting, 62
- auxiliary power supply, wiring, 14
- averaging measured value, description, 3
- averaging measured values, setting process time, 72

B

- BANK input, wiring, 15
- bank selection, 104
- BANK1 signal, 104
- BANK2 signal, 104
- Base Unit, available models, 133
- baud rate, setting, 67
- BCD output, ratings, 126
- BCD Output Boards
 - connectors, 116
 - operation, 115
 - timing charts, 119

C

- characteristics, 127
- chattering, preventing, 78
- combination output boards, 19
- communications, ratings, 126
- communications format, setting, 69
- communications function, 9
- communications unit number, setting, 67
- comparative output pattern, setting, 80
- comparative output selection, description, 2
- comparative outputs, setting, 81
- counting value reset prohibit, setting, 93

D

- default values, initializing set values, 113
- dimensions, 12
- display
 - description, 4
 - troubleshooting, 122

E–F

- error messages, 122
- error ratio, 28
 - operating mode setting, 58
- estimated frequency calculation, 129
- examples, setting examples, 139
- external control inputs, 15
- external input signals, operation, 104
- flashing display, 122
- flow rate ratio, 34
 - operating mode setting, 58

H

- HOLD input, wiring, 15
- HOLD input, description, 2
- HOLD signal
 - mode F7, 106
 - modes F1 to F6, 105
- host computer, unit number setting, 67
- hysteresis setting, setting, 78
- hysteresis setting, description, 3

I

- indicators, description, 4
- Initialization, of set values, 113
- input block, 13
- inputs, wiring, 14

L

- LED indicators, description, 4
- level output, 81
- linear output, ratings, 126
- linear output boards, 19
- linear output range, setting, 83

linear output range, teaching, 111

local programming, setting, 86

M

Maintenance mode, 9

Maintenance mode, operation, 113

maximum value clear prohibit, setting, 95

maximum values, displaying and resetting, 103

measured values, setting averaging time, 72

memory error, 122

menu overview

Protect mode, 89

Setting mode, 48

menus

option menu, 72

prescaling menu, 54

protect menu, 90

setting value menu, 50

setup menu, 58

minimum value clear prohibit, setting, 95

minimum values, displaying and resetting, 103

model numbers, meaning, 134

models, standard models, 133

modes, operating modes, 8

mounting method, 13

O

open collector input, wiring, 14

operating mode

basic operation, 21

setting, 58

operating modes

1 – rotational/circumferential speed, 22

12 – pulse counting, 40

13 – passing time, 37

2 – absolute ratio, 25

3 – error ratio, 28

4 – rotational difference, 31

5 – flow rate ratio, 34

operation keys, description, 4

option menu, 72

output board, 16

Output Boards

available models, 133

available parameters, 135

output error, 122

output test, operation, 112

output test function, description, 3

P

panel cutouts, 12

parameter settings, 45

procedures, 46

parameters

available in each Output Board, 135

list, 131

parity bits, setting, 69

PASS output, 80

passing speed, operating mode setting, 58

passing time, 37

power failure memory, setting, 76

Power Supply, wiring, 14

power supply, wiring auxiliary power supply, 14

prescaling, description, 2

precautions

general, xi

wiring, 14

prescaling, settings, 54

prescaling menu, 54

prescaling value, teaching, 109

protect menu, 90

Protect mode, 9

Protect mode, 88

selecting, 88

pulse counting, 40

operating mode setting, 58

R

ratings, 125

relay contact output, ratings, 126

relay input, setting, 60

relay output boards, 18

remote/local programming, setting, 86

remote/local selection, description, 3

RESET input, wiring, 15

RESET input, description, 3

RESET signal

mode F7, 105

modes F1 to F6, 104

rotational difference, 31

operating mode setting, 58

rotational/circumferential speed, 22

operating mode setting, 58

RUN mode, 8

RUN mode, operations, 99

S

- Security, setting, 97
- sensor type, setting, 60
- set value, teaching, 108
- set value menu, 50
- set values, 50
 - changing, 100
 - displaying, 100
 - initializing, 113
 - protecting, 91
 - setting ranges, 50
- setting examples, 139
- Setting mode, 9
- Setting mode, 47
 - selecting, 47
- Setting Value Change Prohibit, setting, 91
- settings
 - list, 131
 - protecting, 97
- setup, 11
- setup menu, 58
- specifications, 125
- standard models, 133
- standard output, 80
- startup compensation time
 - description, 3
 - setting, 74

- stop bits, setting, 69

T

- teaching, description, 3
- teaching function, operation, 108
- terminal arrangement, BCD Output Boards, 116
- terminal arrangement
 - input block, 13
 - output board, 16
- terminal arrangement, 7
- time units, setting, 65
- timing charts, for BCD Output Boards, 119
- transistor input, setting, 60
- transistor output, ratings, 126
- transistor output boards, 19
- troubleshooting, 121

U–Z

- unit number, setting, 67
- voltage pulse input, wiring, 14
- wiring, 14
- word length, setting, 69
- zone output, 81

Revision History

A manual revision code appears as a suffix to the catalog number on the front cover of the manual.

Cat. No. N093-E1-1A

↑
— Revision code

The following table outlines the changes made to the manual during each revision. Page numbers refer to the previous version.

Revision code	Date	Revised content
1	January 1998	Original production
1A	February 2001	The information under <i>Notice</i> was moved from the inner front cover to page 123 and the address used in the inner back cover was updated. In addition, the following changes were made. Pages 7 and 8: Shading added to graphics. Pages 16 and 17: Changes made to graphics. Page 112: “Escape” corrected to “Mode” in first line of procedure. Page 118: Minor additions made to graphic. Page 123: Note directing the reader to <i>Notice</i> removed. Page 124: Information on rated load voltage changed in 2 places. Page 125: “NEMA4” changed to “NEMA4X.” Page 133: Alignment for entry on startup compensation time corrected.

OMRON CORPORATION

Industrial Automation Company

Measuring and Supervisory Controls Department
Shiokoji Horikawa, Shimogyo-ku,
Kyoto, 600-8530 Japan
Tel: (81)75-344-7108/Fax: (81)75-344-7189

Regional Headquarters

OMRON EUROPE B.V.

Wegalaan 67-69, NL-2132 JD Hoofddorp
The Netherlands
Tel: (31)2356-81-300/Fax: (31)2356-81-388

OMRON ELECTRONICS LLC

1 East Commerce Drive, Schaumburg, IL 60173
U.S.A.
Tel: (1)847-843-7900/Fax: (1)847-843-8568

OMRON ASIA PACIFIC PTE. LTD.

83 Clemenceau Avenue,
#11-01, UE Square,
239920 Singapore
Tel: (65)835-3011/Fax: (65)835-2711

OMRON CHINA CO., LTD.

BEIJING OFFICE
Room 1028, Office Building,
Beijing Capital Times Square,
No. 88 West Chang'an Road,
Beijing, 100031 China
Tel: (86)10-8391-3005/Fax: (86)10-8391-3688

OMRON

Authorized Distributor:

Cat. No. N093-E1-1A

K3NR Frequency/Rate Meter

OPERATION MANUAL

OMRON