

**NT20**

# **Programmable Terminal**

## **USER'S MANUAL**

# **OMRON**

# NT-series Programmable Terminal

## User's Manual

*Produced March 2007*

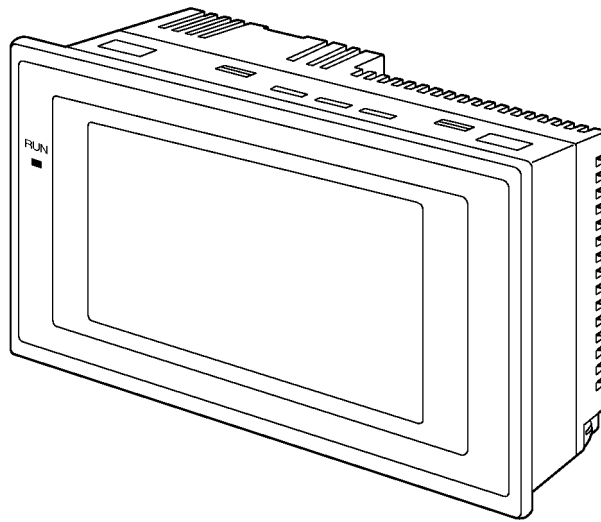





## Notice:

OMRON products are manufactured for use according to proper procedures by a qualified operator and only for the purposes described in this manual.

The following conventions are used to indicate and classify precautions in this manual. Always heed the information provided with them. Failure to heed precautions can result in injury to people or damage to property.

 **DANGER** Indicates an imminently hazardous situation which, if not avoided, will result in death or serious injury. Additionally, there may be severe property damage.

 **WARNING** Indicates a potentially hazardous situation which, if not avoided, could result in death or serious injury. Additionally, there may be severe property damage.

 **Caution** Indicates a potentially hazardous situation which, if not avoided, may result in minor or moderate injury, or property damage.

## OMRON Product References

All OMRON products are capitalized in this manual. The word “Unit” is also capitalized when it refers to an OMRON product, regardless of whether or not it appears in the proper name of the product.

The abbreviation “Ch,” which appears in some displays and on some OMRON products, often means “word” and is abbreviated “Wd” in documentation in this sense.

The abbreviation “PLC” means Programmable Controller. “PC” is used, however, in some Programming Device displays to mean Programmable Controller.

The abbreviation “Host” means a PLC that controls the NT20.

## Visual Aids

The following headings appear in the left column of the manual to help you locate different types of information.

**Note** Indicates information of particular interest for efficient and convenient operation of the product.

**1,2,3...** 1. Indicates lists of one sort or another, such as procedures, checklists, etc.

## © OMRON, 2007

All rights reserved. No part of this publication may be reproduced, stored in a retrieval system, or transmitted, in any form, or by any means, mechanical, electronic, photocopying, recording, or otherwise, without the prior written permission of OMRON.

No patent liability is assumed with respect to the use of the information contained herein. Moreover, because OMRON is constantly striving to improve its high-quality products, the information contained in this manual is subject to change without notice. Every precaution has been taken in the preparation of this manual. Nevertheless, OMRON assumes no responsibility for errors or omissions. Neither is any liability assumed for damages resulting from the use of the information contained in this publication.



# TABLE OF CONTENTS

<b>PRECAUTIONS</b> .....	<b>xvii</b>
1 Intended Audience .....	xviii
2 General Precautions .....	xviii
3 Safety Precautions .....	xviii
4 Operating Environment Precautions .....	xix
5 Application Precautions .....	xix
6 EC Directives .....	xx
<b>SECTION 1</b>	
<b>Functions of the NT20</b> .....	<b>1</b>
1-1 Role and Operation of NT20 .....	2
1-2 Functions of NT20 .....	4
1-3 Method for Connection to the Host .....	8
1-4 Communications with PLC by Direct Connection .....	10
1-5 Communications Using RS-232C (NT20-ST128) .....	13
1-6 Before Operating .....	14
<b>SECTION 2</b>	
<b>Hardware Settings and Connections</b> .....	<b>17</b>
2-1 Description of Parts and Settings .....	18
2-2 Installation .....	21
2-3 Connecting Link Adapters and RS-422A Converters .....	24
2-4 Connecting the NT Support Tool .....	35
2-5 Using a Memory Unit .....	36
2-6 Connecting to the RS-232C Port at the Host .....	44
2-7 Communicating with the PLC Using C200H Direct Communications .....	73
2-8 Host Connections by RS-232C (NT20-ST128) .....	79
<b>SECTION 3</b>	
<b>System Menu Operation</b> .....	<b>81</b>
3-1 Operation Flow by the System Menu .....	82
3-2 Starting the NT20 .....	83
3-3 Operation Modes and the System Menu .....	84
3-4 Initializing Memory .....	88
3-5 Setting the Conditions of Communications with the Host by Using the Memory Switches .....	91
3-6 Registering the Screen Data .....	102
3-7 Starting the Operation .....	105
3-8 Various System Settings .....	106
3-9 System Maintenance .....	115
3-10 Transferring the System Program .....	126
3-11 Transferring the Resource Data .....	129

# TABLE OF CONTENTS

## SECTION 4

### **NT20 Functions and Operation . . . . . 133**

4-1	Screen Creation Procedure . . . . .	134
4-2	Outline of Functions . . . . .	136
4-3	Screen Display . . . . .	140
4-4	Memory Tables . . . . .	144
4-5	Bar Graphs . . . . .	147
4-6	Lamps . . . . .	150
4-7	Touch Switches . . . . .	152
4-8	Numeral Setting . . . . .	156

## SECTION 5

### **How to Use the Host Link/NT Link . . . . . 165**

5-1	Overview of Direct Connection Operations . . . . .	166
5-2	Memory Tables and Bar Graphs . . . . .	177
5-3	Lamps, Touch Switches, Numerical Setting . . . . .	191
5-4	NT20 Status Control . . . . .	203
5-5	Notification of the Operating Status to the PLC (Determining the NT20 Operating Status) . . . . .	208

## SECTION 6

### **Using RS-232C Communications . . . . . 211**

6-1	Table of Commands . . . . .	212
6-2	RS-232C Communications . . . . .	213
6-3	Screen Display . . . . .	216
6-4	Memory Tables . . . . .	218
6-5	Lamps, Touch Switches, Numerical Setting . . . . .	221
6-6	Controlling the NT20 Status . . . . .	227
6-7	Terminal Commands . . . . .	229
6-8	Key to Programs . . . . .	234

## SECTION 7

### **Troubleshooting and Maintenance . . . . . 247**

7-1	Hardware Faults . . . . .	248
7-2	Responding to Displayed Error Messages . . . . .	249
7-3	Maintenance of the NT20 . . . . .	253
7-4	Inspection and Cleaning . . . . .	253

## Appendices

A	Specifications . . . . .	255
B	Dimensions . . . . .	261
C	Transporting and Storing PTs . . . . .	263

# TABLE OF CONTENTS

D	Making the Cable .....	265
E	Making the Cable for Connecting a Personal Computer .....	267
F	Model List .....	269
G	Option List .....	277
H	Special Characters .....	279
I	Function Restrictions Depending on the Support Tool .....	281
<b>Index.....</b>		<b>283</b>
<b>Revision History .....</b>		<b>287</b>



# TABLE OF CONTENTS

## About this Manual:

This manual describes the basic functions and operation procedures of the NT-series programmable terminal NT20, its operations when connected to a PLC or a Host, and includes the sections described below.

Please read this manual carefully and be sure you understand the information provided before attempting to install and operate the NT-series programmable terminal NT20.

 **WARNING** Failure to read and understand the information provided in this manual may result in personal injury or death, damage to the product, or product failure. Please read each section in its entirety and be sure you understand the information provided in the section and related sections before attempting any of the procedures or operations given.

**Precautions** provides general precautions for using the NT20 and related devices.

**Section 1** describes the operation functions, system configuration, and the direct connection function of the NT20.

**Section 2** describes the NT20 hardware settings, its installation in an operation panel, its connection to the Host, etc.

**Section 3** describes the procedure before operating the NT20, and useful functions when operating it. Also describes how to perform an operation check.

**Section 4** describes the functions of the NT20 when it is connected to a Host.

**Section 5** describes how to operate the NT20 when the host link/NT link is used for communications.

**Section 6** describes how to operate the NT20 when the RS-232C interface is used for communications. Read this section only when using the NT20-ST128.

**Section 7** describes the procedures to follow when the system does not operate correctly, and the procedure for routine maintenance of the NT20.

**APPENDIX** describes the specifications and the method for making connecting cables, and includes an area list for the PLC.

 **WARNING** Failure to read and understand the information provided in this manual may result in personal injury or death, damage to the product, or product failure. Please read each section in its entirety and be sure you understand the information provided in the section and related sections before attempting any of the procedures or operations given.

## ***Related Manuals and Their Contents:***

The related manuals are indicated below.

The □ symbol at the end of the manual number is the revision history symbol.

### **Operating the Programmable Terminal and Communicating with the Host**

- NT20 Programmable Terminal User's Manual (V091)  
----- This manual

This user's manual is the manual for the NT20 itself.

The NT20 is a unit which integrates a programmable terminal body and host interface unit. This user's manual describes the functions and handling of both the programmable terminal body and the host interface function.

### **Creating and Transferring Screen Data**

- NT Support Tool for Windows Ver.4 □ Operation Manual (V061-E1-□)

The screens displayed on the NT20 are created with the Support Tool and transferred to the NT20. This manual describes how to create and transfer screen data. It also describes how to download a system program to a PT using the System Installer.

### **Connection to Other Makers' PLCs**

- PLC Connection V042-E1-□

NT20-ST121-E can be connected to Mitsubishi A series PLCs. This manual describes how to make the connection and how to make settings when connecting the PT to a Mitsubishi A series PLC.

In order to use the PT while connected to a PLC made by a manufacturer other than OMRON, the Ver. 2.3 Support Tool must be used.

## ***Read and Understand this Manual***

Please read and understand this manual before using the product. Please consult your OMRON representative if you have any questions or comments.

## ***Warranty and Limitations of Liability***

### ***WARRANTY***

OMRON's exclusive warranty is that the products are free from defects in materials and workmanship for a period of one year (or other period if specified) from date of sale by OMRON.

OMRON MAKES NO WARRANTY OR REPRESENTATION, EXPRESS OR IMPLIED, REGARDING NON-INFRINGEMENT, MERCHANTABILITY, OR FITNESS FOR PARTICULAR PURPOSE OF THE PRODUCTS. ANY BUYER OR USER ACKNOWLEDGES THAT THE BUYER OR USER ALONE HAS DETERMINED THAT THE PRODUCTS WILL SUITABLY MEET THE REQUIREMENTS OF THEIR INTENDED USE. OMRON DISCLAIMS ALL OTHER WARRANTIES, EXPRESS OR IMPLIED.

### ***LIMITATIONS OF LIABILITY***

OMRON SHALL NOT BE RESPONSIBLE FOR SPECIAL, INDIRECT, OR CONSEQUENTIAL DAMAGES, LOSS OF PROFITS OR COMMERCIAL LOSS IN ANY WAY CONNECTED WITH THE PRODUCTS, WHETHER SUCH CLAIM IS BASED ON CONTRACT, WARRANTY, NEGLIGENCE, OR STRICT LIABILITY.

In no event shall the responsibility of OMRON for any act exceed the individual price of the product on which liability is asserted.

IN NO EVENT SHALL OMRON BE RESPONSIBLE FOR WARRANTY, REPAIR, OR OTHER CLAIMS REGARDING THE PRODUCTS UNLESS OMRON'S ANALYSIS CONFIRMS THAT THE PRODUCTS WERE PROPERLY HANDLED, STORED, INSTALLED, AND MAINTAINED AND NOT SUBJECT TO CONTAMINATION, ABUSE, MISUSE, OR INAPPROPRIATE MODIFICATION OR REPAIR.

# ***Application Considerations***

## ***SUITABILITY FOR USE***

OMRON shall not be responsible for conformity with any standards, codes, or regulations that apply to the combination of products in the customer's application or use of the products.

At the customer's request, OMRON will provide applicable third party certification documents identifying ratings and limitations of use that apply to the products. This information by itself is not sufficient for a complete determination of the suitability of the products in combination with the end product, machine, system, or other application or use.

The following are some examples of applications for which particular attention must be given. This is not intended to be an exhaustive list of all possible uses of the products, nor is it intended to imply that the uses listed may be suitable for the products:

- Outdoor use, uses involving potential chemical contamination or electrical interference, or conditions or uses not described in this manual.
- Nuclear energy control systems, combustion systems, railroad systems, aviation systems, medical equipment, amusement machines, vehicles, safety equipment, and installations subject to separate industry or government regulations.
- Systems, machines, and equipment that could present a risk to life or property.

Please know and observe all prohibitions of use applicable to the products.

**NEVER USE THE PRODUCTS FOR AN APPLICATION INVOLVING SERIOUS RISK TO LIFE OR PROPERTY WITHOUT ENSURING THAT THE SYSTEM AS A WHOLE HAS BEEN DESIGNED TO ADDRESS THE RISKS, AND THAT THE OMRON PRODUCTS ARE PROPERLY RATED AND INSTALLED FOR THE INTENDED USE WITHIN THE OVERALL EQUIPMENT OR SYSTEM.**

## ***PROGRAMMABLE PRODUCTS***

OMRON shall not be responsible for the user's programming of a programmable product, or any consequence thereof.

## **Disclaimers**

### ***CHANGE IN SPECIFICATIONS***

Product specifications and accessories may be changed at any time based on improvements and other reasons.

It is our practice to change model numbers when published ratings or features are changed, or when significant construction changes are made. However, some specifications of the products may be changed without any notice. When in doubt, special model numbers may be assigned to fix or establish key specifications for your application on your request. Please consult with your OMRON representative at any time to confirm actual specifications of purchased products.

### ***DIMENSIONS AND WEIGHTS***

Dimensions and weights are nominal and are not to be used for manufacturing purposes, even when tolerances are shown.

### ***PERFORMANCE DATA***

Performance data given in this manual is provided as a guide for the user in determining suitability and does not constitute a warranty. It may represent the result of OMRON's test conditions, and the users must correlate it to actual application requirements. Actual performance is subject to the OMRON Warranty and Limitations of Liability.

### ***ERRORS AND OMISSIONS***

The information in this manual has been carefully checked and is believed to be accurate; however, no responsibility is assumed for clerical, typographical, or proofreading errors, or omissions.



# PRECAUTIONS

This section provides general precautions for using the Programmable Terminal.

**The information contained in this section is important for the safe and reliable application of the Programmable Terminal. You must read this section and understand the information contained before attempting to set up or operate a Programmable Terminal.**

1	Intended Audience .....	xviii
2	General Precautions .....	xviii
3	Safety Precautions.....	xviii
4	Operating Environment Precautions .....	xix
5	Application Precautions .....	xix
6	EC Directives .....	xx



## 1 Intended Audience

This manual is intended for the following personnel, who must also have knowledge of electrical systems (an electrical engineer or the equivalent).

- Personnel in charge of introducing FA systems into production facilities.
- Personnel in charge of installing FA systems.
- Personnel in charge of designing and connecting FA systems.
- Personnel in charge of managing FA systems and facilities.

## 2 General Precautions

- The user must operate the product according to the performance specifications described in the operation manuals.
- Before using the product under conditions which are not described in the manual or applying the product to nuclear control systems, railroad systems, aviation systems, vehicles, combustion systems, medical equipment, amusement machines, safety equipment, and other systems, machines, and equipment that may have a serious influence on lives and property if used improperly, consult your OMRON representative.
- Make sure that the ratings and performance characteristics of the product are sufficient for the systems, machines, and equipment, and be sure to provide the systems, machines, and equipment with double safety mechanisms.
- This manual provides information for using the Programmable Terminal. Be sure to read this manual before attempting to use the software and keep this manual close at hand for reference during operation.

 **WARNING** It is extremely important that Programmable Terminals and related devices be used for the specified purpose and under the specified conditions, especially in applications that can directly or indirectly affect human life. You must consult with your OMRON representative before applying Programmable Terminals to the abovementioned applications.

 **WARNING** Do not use the input functions of the PT, such as touch switches or function keys, for applications where danger to human life or serious property damage is possible or for emergency switch applications.

## 3 Safety Precautions

Read these safety precautions carefully and make sure you understand them before using the Programmable Terminal so that you can use it safely and correctly.

 **WARNING** Do not attempt to take the PLC apart and do not touch any internal parts while the power is being supplied. Doing either of these may result in electrical shock.

 **Caution** Carefully check the wiring before turning ON the power.

 **Caution** Do not connect AC power to the DC terminals. Incorrect wiring may result in burning.

 **Caution** If the DIP switch settings have been changed when the NT20 is powered, reset the power to the NT20. The changes with the DIP switches become effective only after the power supply is reset.

## 4 Operating Environment Precautions

- 1,2,3...**
1. Do not install the PT in any of the following locations.
    - Locations subject to rapid changes in temperature
    - Locations subject to temperatures or humidity outside the range specified in the specifications
    - Locations subject to condensation as the result of high humidity
    - Locations subject to splashing chemicals or solvents
    - Locations subject to oil splashes
    - Locations subject to corrosive or flammable gases
    - Locations subject to strong shock or vibration
    - Locations outdoors subject to direct wind and rain
    - Locations subject to strong ultraviolet light
  2. Take appropriate and sufficient countermeasures when installing systems in the following locations.
    - Locations subject to static electricity or other forms of noise
    - Locations subject to strong electromagnetic or magnetic fields
    - Locations close to power supply lines
    - Locations subject to possible exposure to radioactivity

## 5 Application Precautions

- 1,2,3...**
1. When unpacking the PT, check carefully for any external scratches or other damage. Also, shake the PT gently and check for any abnormal sound.
  2. Turn OFF the power supply to the PT before mounting or dismounting any Interface Unit, such as a Memory Unit. Correctly mount the Interface Unit according to the NT20 User's Manual.
  3. Do not touch PCBs with bare hands. Discharge static electricity accumulated in your body in advance.
  4. The mounting panel must be between 1.6 and 4.8 mm thick. Tighten the Mounting Brackets evenly to a torque of between 0.5 and 0.6 N·m to maintain water and dust resistance. Make sure the panel is not dirty or warped and that it is strong enough to hold the PT.
  5. Do not let metal particles enter the PT when preparing the panel.
  6. Do not perform a dielectric voltage test on the PT.
  7. Use a DC power supply that is isolated between DC output and AC input, and has minimal fluctuation voltage.  
Rated power supply voltage: 24 VDC (Allowable range: 20.4 to 27.6 VDC)  
Capacity: 10 W min.
  8. Use a twisted-pair cable of at least 2 mm<sup>2</sup> to connect to the power supply terminals. Tighten the terminal screws to 0.8 N·m. Make sure the screws are properly tightened.
  9. Turn OFF the power supply to the PT before connecting or disconnecting cables between devices.

10. Always tighten the connector screws after connecting communications cables.
11. The maximum pull load for cables is 30 N. Do not apply loads greater than this.
12. Confirm that the current capacity of the connected device is 150 mA or less before using the 5-V power supply from pin 6 of serial port A or port B. The 5-V output of the NT20 is 150 mA maximum at 5 V  $\pm$ 5%.
13. Confirm the safety of the system before turning ON or OFF the power supply or pressing the reset switch.
14. The whole system may stop depending on how the power supply is turned ON or OFF. Turn ON or OFF the power supply according to the specified procedure.
15. Start actual system application only after sufficiently checking screen data and the operation of the program in the PLC (host).
16. Do not press any touch switch with a force greater than 30 N.
17. Do not accidentally press touch switches when the Backlight is not lit or when the display does not appear. Confirm the safety of the system before pressing touch switches.
18. Signals from the touch switches may not be input if the switches are pressed consecutively at high speed. Confirm each input before proceeding to the next touch switch.
19. To ensure greater safety for numeric inputs, use the upper/lower limit setting function.
20. When transferring data in screen units, also transfer any data associated with the screen, such as memory tables or direct connection data, if any of this data has changed.
21. To assure system safety, incorporate a program that periodically calls PT operation bits from the host side to check that the PT is properly operating.
22. An afterimage will remain if the same patterns are displayed continuously for extended periods of time (e.g., 24 hours). Use the screen saver or periodically change the display to prevent afterimages.
23. Do not use benzene, paint thinner, or other volatile solvents, and do not use chemically treated cloths.
24. Do not attempt to disassemble, repair, or modify the PT in any way.
25. The backlight in the PT contains mercury. Do not dispose of the PT together with waste to be processed at disposal plants. Dispose of the PT according to all local laws, regulations, and ordinances as they apply.
26. Confirm the installation conditions periodically when the PT is being used in an environment subject to oil or water.
27. Water resistance will be lost if the front sheet is not present. Confirm that the front sheet is present before using the PT.

## 6 EC Directives

### Conforming Directive

The NT20 PTs conform to the EMC Directive.

**EMC Directive Conformance**

OMRON products are designed as electrical devices for use built into other devices or the overall machine. As individual devices, they comply with the related EMC standards (see note) so that they can more easily be built into other devices or the overall machine. The actual products have been checked for conformity to EMC standards. Whether they conform to the standards in the system used by the customer, however, must be checked by the customer.

EMC-related performance of the OMRON devices will vary depending on the configuration, wiring, and other conditions of the equipment or control panel on which the OMRON devices are installed. The customer must, therefore, perform the final check to confirm that devices and the overall machine conform to EMC standards.

**Note** Applicable EMC (Electromagnetic Compatibility) standards are as follows:

EMS (Electromagnetic Susceptibility):	EN 61131-2
EMI (Electromagnetic Interference):	EN 61131-2 (Radiated emission: 10-m regulations)

**Complying with EC Directives**

NT-series PTs comply with EC Directives. Observe the following precautions to ensure that the customer's device and the overall machine also comply with EC Directives.

- 1,2,3...**
1. The PT is designed for installation inside a control panel. The PT must be installed within a control panel.
  2. Use reinforced insulation or double insulation for the DC power supply to the PT. Ensure that a stable power output can be provided even if a 10-ms interruption occurs at the input.
  3. The PT conforms to the EN 61131-2, but the radiated emission characteristics (10-m regulations) may vary depending on the configuration of the control panel used, other devices connected to the control panel, wiring, and other conditions. You must therefore confirm that the overall machine or equipment complies with EC Directives.



# SECTION 1

## Functions of the NT20

NT20 is a new programmable terminal (PT) which incorporates a host interface unit and two RS-232C interface units in a programmable terminal body. It can be easily installed and used. This section gives the operation examples and characteristics of the NT20 so that you will understand the applications of the NT20.

1-1	Role and Operation of NT20 . . . . .	2
1-1-1	Operations of NT20 . . . . .	3
1-2	Functions of NT20 . . . . .	4
1-2-1	Features . . . . .	4
1-2-2	Principal Functions of NT20 . . . . .	5
1-2-3	Comparison between NT20S, NT20M, and NT20 . . . . .	6
1-2-4	Displays . . . . .	7
1-3	Method for Connection to the Host . . . . .	8
1-4	Communications with PLC by Direct Connection . . . . .	10
1-4-1	Functions of the Allocated Bits and Words . . . . .	10
1-4-2	Connecting to PLC from Other Companies . . . . .	12
1-5	Communications Using RS-232C (NT20-ST128) . . . . .	13
1-6	Before Operating . . . . .	14

# 1-1 Role and Operation of NT20

NT20 is a programmable terminal used to display and transmit the information in an FA site. The following gives a general description of the role and operation of the NT20 for those who use a programmable terminal (PT) for the first time.

## Production Line Status Monitoring

The NT20 displays real-time information about the system and equipment operating status, etc.

Production Control		1994/1/25
Product	NT20M/NT20S	NT600M
Today's target	560 units	441 units
Current Production	305 units	275 units
% achieved	54.5 %	63.0 %

## Messages

The NT20 warns of system or equipment failures and prompts the appropriate remedial action.

# Alarm

Assembly line B
-
Positioning pin

is defective.

## Panel Switch Functions

Setting touch switches on the NT20 allows workers to use the NT20 as an operating panel. Production data input to the NT20 or the Host can be transmitted to a PLC.

Electroplating Control

---

Transport

↑

←

→

↓

Clamp

UnClamp

### 1-1-1 Operations of NT20

#### Displays Screens

The information to be displayed (screen data) can be created on a computer by using the Support Tool and stored in the NT20. The screen data can be displayed on the NT20 in response to the instructions from a Host or touch switch operation.

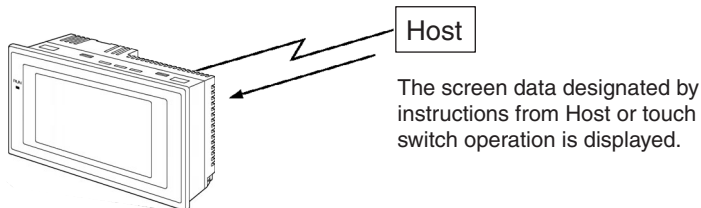

#### Receives Data from a Host

The NT20 can be connected to the Host using the host link or NT link communications method to enable reception of the required data from the Host.

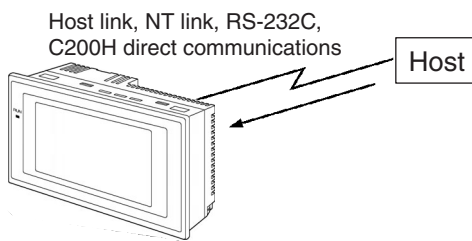

#### Sends Data to a Host

Data input through a touch panel can be sent to a Host.

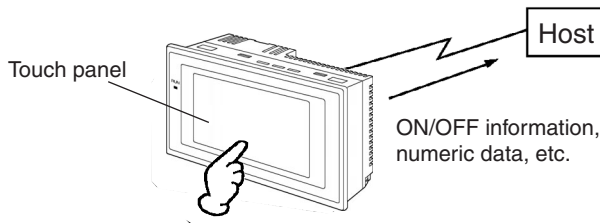

#### Screen Data

The screen data to be displayed on the NT20 can be created by a computer by using the Support Tool. Connect the NT20 to a PC/AT with an RS-232C cable so that the screen data are transferred to the NT20.

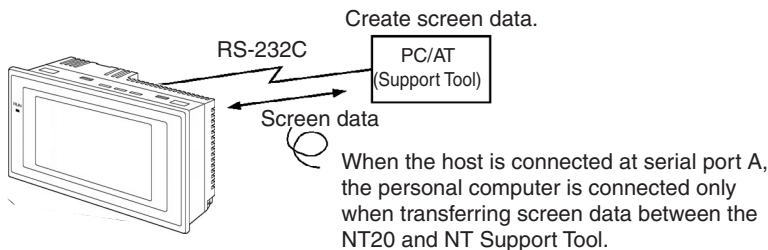



## 1-2 Functions of NT20

The NT20 has the following features which are different from those of existing NT20M/NT20S;

### 1-2-1 Features

#### Downsized Body

- The connectors are located at other than the front.
- The communications cable connectors are housed in the unit so that they do not protrude from the unit.
- The tool connectors and the Host communications connectors are used in common (when the host link/NT link is used).

#### Construction Best Suited to the FA Environment

- Easy-to-read screen even in direct sunlight.
- Long-lived backlight leads free from maintenance.
- Waterproof structure equivalent to oil-resistant IP65.

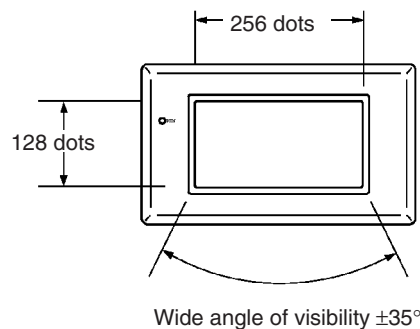

#### A Host Link I/F Unit, Screen Data Memory, and a System ROM Are All Incorporated

- With the NT link communications method, 1:1 connections and 1:N connections are possible.
- There is no complicated installation work except a simple connection to a Host.
- A flash memory is used for the screen data memory. There is no need of backup battery.
- The following communications methods are standard for each model:  
 NT20-ST121-E: Host Link (direct) and NT Link  
 NT20-ST121-E + NT20-IF001 + NT600M-LB122-V1: C200H direct communications  
 NT20-ST128: RS-232C communications (command control)
- The NT20 can be connected to Mitsubishi FX-series and Mitsubishi A-series PLCs. (Refer to *PLC Connection, Operation Manual* (Cat. No. V042-E1-□)).

#### Touch Switch Operation

The System Menu can be displayed by using the touch switches located in four corners of the screen.

#### Compatibility with NT20M/NT20S

Existing screen data, user programs, are compatible.

## 1-2-2 Principal Functions of NT20

### Functions Related to the Data Display

- Character display  
Characters of various sizes can be displayed. Characters can flash or be highlighted.
- Figure display  
Straight lines, circles, and other graphic figures can be displayed.
- Memory data display  
Contents of the character-string memory table and the numeral memory table can be displayed. The memory table contents can be changed from the PLC/Host.
- Bar graph display  
Bar graphs corresponding to the contents of the numeral memory table can be displayed.
- Lamp display  
Lamps which turn on or flash as controlled by the Host can be displayed.

### Functions Related to the Data Input

- Input by the touch switch  
Data can be input by simply touching the screen.
- Numeric setting function  
The touch keys can be assigned with numeric values so that the numeric values can be input at the operation site and sent to the PLC/Host.

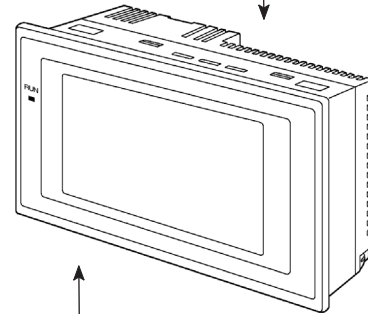

### Other Functions

- Buzzer  
A built-in buzzer can be used.
- Communications with a PLC  
By connecting the NT20 with a PLC using the host link, NT link, C200H, or RS-232C communications method, data can be received from the host and touch switch status information can be sent to the host.
- System function  
The system setting and maintenance can be executed by using the System Menu on the screen.
- Screen data creation  
The screen data can be created by using support tools on the computer and stored in the unit.
- Unrestricted screen display  
When the NT20 is connected to the host via an RS-232C interface, characters and graphics can be displayed independently of the registered screens (terminal function) (only with NT20-ST128).

### 1-2-3 Comparison between NT20S, NT20M, and NT20

The NT20 is a unitary PT which incorporates a system ROM, screen memory, and a host I/F unit (Host link, NT link, RS-232C, and C200H direct communications) as the standard equipment in one body.

The NT20 has the following features which are different from those of existing NT20/NT20S:

Function	NT20S	NT20M-DT121-V2	NT20
Communications	<ul style="list-style-type: none"> <li>• Host link/NT link incorporated NT20S-ST121-EV3</li> <li>• C200H direct communications incorporated NT20S-ST122-V1</li> <li>• RS-232C incorporated NT20S-ST128 (other host I/F units cannot be connected)</li> </ul>	Host I/F units are required.	<ul style="list-style-type: none"> <li>• Host link/NT link</li> <li>• C200H direct communications Host I/F unit for C200H communications is required.</li> <li>• RS-232C incorporated NT20-ST128 (other host I/F units can not be connected)</li> </ul>
Communications connector	<ul style="list-style-type: none"> <li>• The communications connector (9-pin) for a Host is shared with that for the Support Tool. (NT20S-ST121-EV3/ST128)</li> <li>• Connectors for Support Tool (9-pin) and Host connections on the rear face (NT20S-ST122-V1).</li> </ul>	The Support Tool connector (9-pin) is located on the front. The Host connector (25-pin) is located on the back.	<ul style="list-style-type: none"> <li>• The communications connector (9-pin) for a Host is shared with that for the Support Tool. (Port A)</li> <li>• The communications connector (9-pin) for a Host (Port B)</li> </ul>
Host RUN input terminal/ Alarm output terminal	Not provided	Provided	Not provided
System keys	Not provided	Provided	Not provided
Contrast control	Back	Front	Back
Waterproof performance	Equivalent to oil-resistant IP65	Conforms to IP54F.	Equivalent to oil-resistant IP65
Allowable momentary power interruption time	Not guaranteed	5 ms	Not guaranteed
System ROM	Built in (not replaceable)	System ROM compatible with host I/F unit is required.	Flash ROM rewriteable
Resume function	Not provided	Provided	Not provided
History retaining function	Not provided	Provided	Not provided
Screen transfer	○	○ (Only possible if screen data memory is an SRAM)	○
Screen data compatibility	○ (Note)	–	○ (Note)
PLC ladder compatibility	○	–	○
Backlight replacement	○	Possible with NT20M-DT131.	Do not need
Screen data memory	Built in (flash ROM only)	Optional (select from EPROM, SRAM, and EEPROM)	Built in (Flash ROM)
Screen data memory capacity	96KB	128 KB max.	512 KB
Outside dimensions	190 × 110 × 58 mm	220 × 110 × 82 mm	190 × 108 × 53.5 mm

**Note** If a system key function is required on continuous screens or for numerical setting or buzzer stop, use the Support Tool and set the touch switches which have the system key function in such screens.

For details, refer to 4-7-3 System Key Functions on page 154.

### 1-2-4 Displays

The NT20 can display various kinds of elements such as characters, lamps, touch switches, and bar graphs on a screen. The screen data displayed on the NT20 are created by using the Support Tool on a computer.

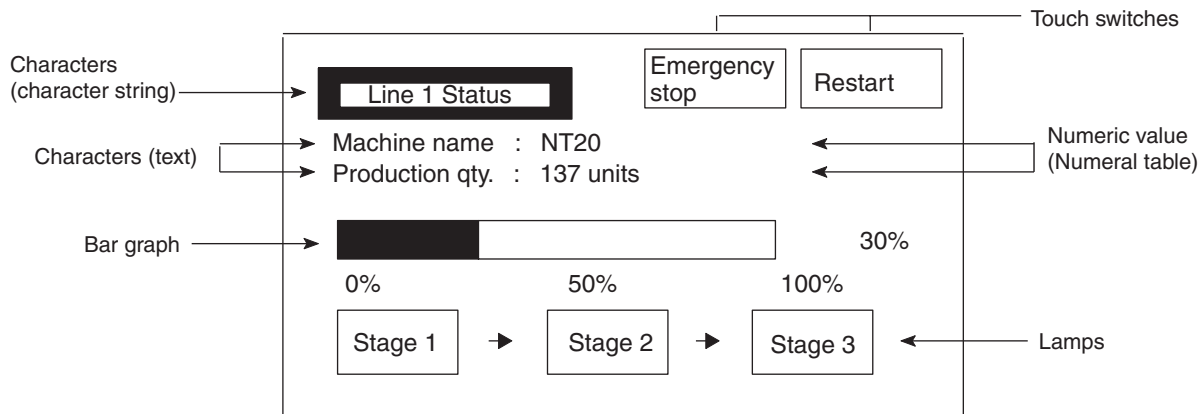

**Characters (Text)** Characters and marks which do not need to be changed can be written directly to the screen.

**Characters (Character-string Memory Table)** Character-strings stored in the character-string memory table are displayed. The display characters can be changed by changing the data stored in the character-string memory table.

**Numeric Values (Numeral Table)** Numbers stored in the numeral table are displayed. The display numbers can be changed by changing the data stored in the numeral table. Hexadecimal values can also be displayed.

**Lamps** Lamps are displayed as square or round frames and indicate the operating status. They are controlled by the Host and can be lit (reversed) or made flash (alternates normal with reversed displays).

**Touch Switches** Touch switches can be set anywhere on the screen. Touching the screen at a touch switch location can switch the display (display switch function) or notify the Host (notification function). The touch switches can be lit or made flash by controlling from the Host in the same way as the lamps.

**Numeric Keys** These are the touch switches used to input numeric values.

**Bar Graphs** The bar graph extends and contracts in proportion to the data stored in the numeral table. A percentage value can also be displayed simultaneously.

**Marks** Marks can be designed, created, and handled like characters by the user.

## 1-3 Method for Connection to the Host

This section describes the methods for connection to the host used with the NT20, and the relationship between the connection method and the communications method.

### **NT20 Communications Ports and Communications Methods**

The NT20 has two communications ports. Their uses are indicated in the table below.

<b>Communications Port</b>	<b>Usable Communications Methods</b>	<b>Communications</b>
Serial port A	Host Link 1:1 NT Link 1:N NT Link (See note.) RS-232C (command control) (NT-20-ST128) (NT Support Tool connection)	RS-232C
Serial port B	Host Link 1:1 NT Link 1:N NT Link (See note.) RS-232C (command control) (NT-20-ST128)	RS-232C

**Note** There are two 1:N NT Link communications rates: standard and high-speed.

### **Converting Communications Type with the RS-232C/RS-422A Link Adapter and RS-422A Converter**

An OMRON NT-AL001 Link Adapter or CJ1W-CIF11 RS-422A Converter can be used convert from RS-232C communications to either RS-422A or RS-485.

- RS-232C ⇔ RS-422A
- RS-232C ⇔ RS-485

There are two models of Link Adapter/RS-422A Converter are available. They provide different features:

- NT-AL001 Link Adapter  
The RS-232C port is insulated from the RS-422A/485 terminals. An RS-232C cable (2 m max.) can be connected to either serial port A or B on the NT20.
- CJ1W-CIF11 RS-422A Converter  
The RS-232C port is **not** insulated from the RS-422A/485 terminals. The CJ1W-CIF11 RS-422A Converter can be connected to either serial port A or B on the NT20.
- Communications Distance  
Use the NT-AL001 if the communications distance exceeds 50 m.

**Combinations of Communications Method and Connection Method**

The connection methods that can be used depending on the communications method used and the communications type for communications between the NT20 and the host are indicated in the table below.

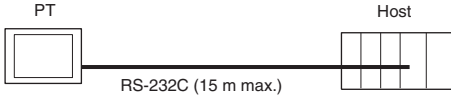
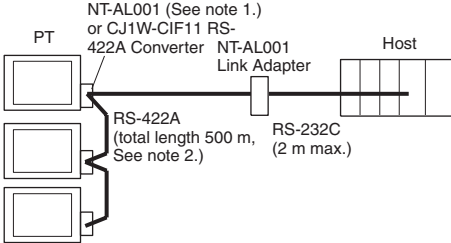
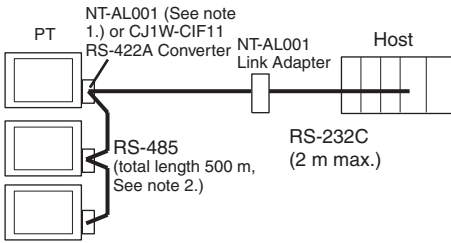
Communications type at Host	Usable Connection Method	Usable Communications Method		
		Host Link	1:1 NT Link	1:N NT Link
RS-232C	Direct 1:1 connection 	○	○	○
RS-232C	1:N connection with RS-422A through Link Adapter and RS-422A Converters 	×	×	○
RS-232C	1:N connection with RS-485 through Link Adapter and RS-422A Converters 	×	×	○

○: Connection possible ×: Connection not possible

- Note**
- (1) An RS-232C Cable (not shown in the diagram) is required when connecting an NT-AL001 Link Adapter to a PT.
  - (2) If the CJ1W-CIF11 is used, the total communications distance is 50 m. This also applies if both the NT-AL001 and CJ1W-CIF11 are used in the same communications path.

# 1-4 Communications with PLC by Direct Connection

## 1-4-1 Functions of the Allocated Bits and Words

When using an NT20-ST121□ with the direct connection function (host link or NT link), the elements displayed on the NT20 and the NT20 status can be allocated to the bits and words of the PLC. By changing the contents of the bits and words, the NT20 can be controlled by the PLC. It is also possible to send data to the PLC by pressing the touch switches on the NT20.

- Controlling the NT20 by a PLC

The following NT20 functions can be controlled by a PLC.

- Screens: Display of designated screens, confirmation of screen numbers, etc.
- Memory tables: Writing to a memory table, copying from a memory table entry to another memory table entry, etc.
- Lamps and touch switches: Display instructions, confirmation of display status, etc.
- System control: Buzzer ON/OFF, backlight ON/OFF, and other NT20 status

- Notifying the PLC from the NT20

Data in the NT20 is sent to a PLC when a touch switch is pressed. The following types of data are sent to a PLC.

- NT20 status
- Touch switch status
- Numerical values input with touch switches by using the numeral setting function
- Changes in a memory table after copying between memory table entries

### Functions of Display Elements

- Lamps

Allocation destination: Bit

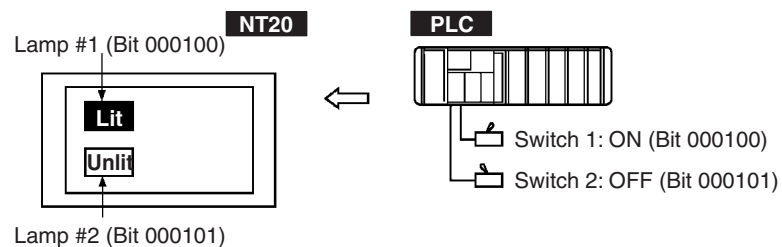

Lamp #2 (Bit 000101)

PLC's bit status is displayed by the "Lamp" on the NT20.

The lamp comes on (flashes) when the PLC's bit status (lamp bit) is ON (1), and goes off when it is OFF (0).

- Touch Switches  
Allocation Destination: Bit

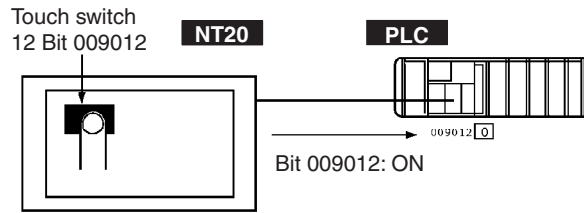

The lamp comes on (flashes) when the PLC's control bit is ON (1) and goes off when it is OFF (0). When the touch switch is pressed, the PLC's notification bit comes ON (1) or goes OFF (0).

- Numeral Memory Table  
Allocation destination: Word

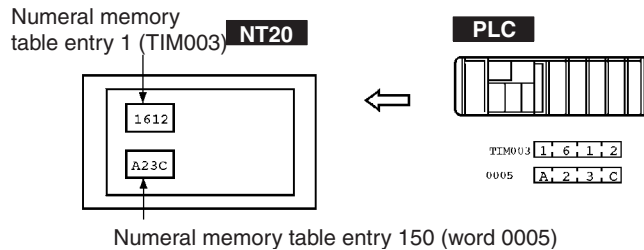

Allocate the numeral memory table entries to arbitrary words in the PLC. If word contents change when corresponding numeral memory table entry is displayed on the screen, the value on the screen will also change. Monitoring of words can also be made easily.

Reading and writing are executed so that the contents of allocated words and contents of numeral memory table entries are always the same during display.

- Character-string Memory Table  
Allocation destination: Word

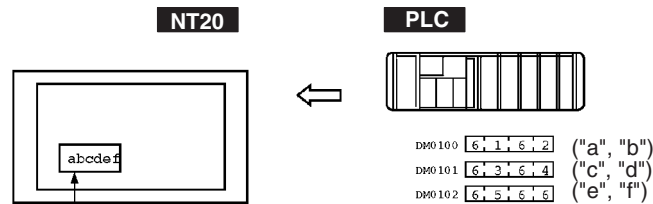

Character-string memory table entry 1  
Allocated word number: 3  
First word: DM0100

Allocate character-string memory table entries to arbitrary words in the PLC. If word contents change when corresponding character-string memory table entry is displayed on the screen, the value on the screen will also change. Messages can be displayed easily.

Reading and writing are executed so that the contents of allocated words and contents of character string memory table entries are always the same during display.



**Functions of the PT Status Control Area (PLC to NT20)**

The “PT status control area” is used to control the NT20 status. When data is written to this area in the PLC, the NT20 reads the contents and operates according to the contents.

**Example of the PT Status Control Area Application**

When data is written to the PT status control area, the NT20 will operate as given below.

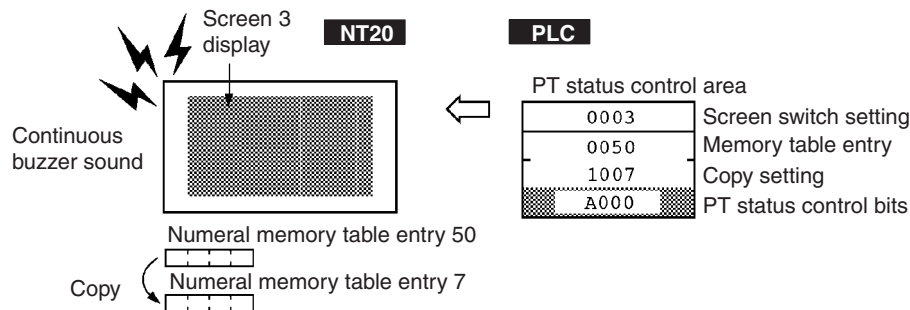

**Functions of the PT Status Notify Area (NT20 to PLC)**

The “PT status notify area” is used to notify the PLC of changes of the NT20 status. When a change is made in the NT20 status, the change is written to this area in the PLC. By reading the data from the area, the NT20 status can be checked.

**Example of the PT Status Notify Area Application**

When a change is made in the NT20 status, such change will be indicated in the PT status notify area as described below.

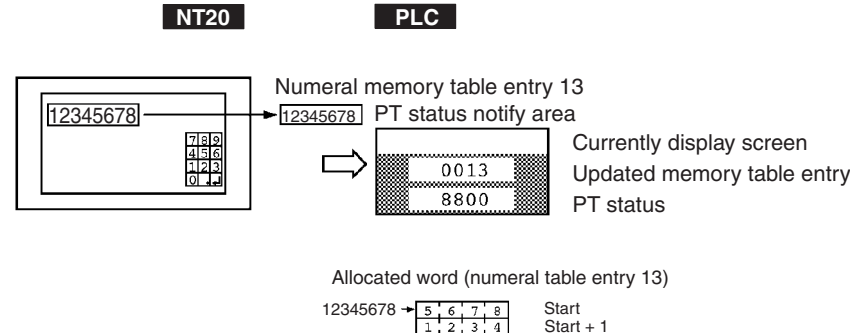

**1-4-2 Connecting to PLC from Other Companies**

The NT20 can be connected to PLCs from other companies using the computer link method.

**Connectable PLCs**

The NT20 can be connected to the following PLCs.

- Mitsubishi A-series Sequencers (via Computer Link Unit)
- Mitsubishi FX-series Sequencers

Refer to the *PLC Connection Manual* (Cat. No. V042) for connection methods.

**NT Series Support Software**

The following Support Software is required when connecting PLCs from other companies.

Support Software: NT-ZJCAT1-EV4(S) (NT Series Support Software for Windows, Version 4.□)

## **1-5 Communications Using RS-232C (NT20-ST128)**

This section gives a brief description of the NT20 control commands sent from the host through the RS-232C interface when the NT20-ST128 is used.

For details on each of the commands sent through the RS-232C interface, refer to *SECTION 6 Using RS-232C Communications*.

Control of the NT20 by a Host is executed by two kinds of commands supported by the RS-232C interface that is built into the NT20.

### **Operation Commands**

Operation commands are used to control the display and status of the running NT20 as well as to provide notification.

They are used for purposes such as screen display, data writing, and enquiries.

Notification of the NT20 operation contents can be provided to the Host.

### **Terminal Commands**

Terminal commands are used to use the NT20 as a display terminal of the Host.

When the NT20 is used as a display terminal, it can display characters and figures according to instructions given by the Host, independently of the screens registered to the NT20.

These commands are also used if unexpected problems occur.

# 1-6 Before Operating

Follow the procedure given below to start the system of the NT20.

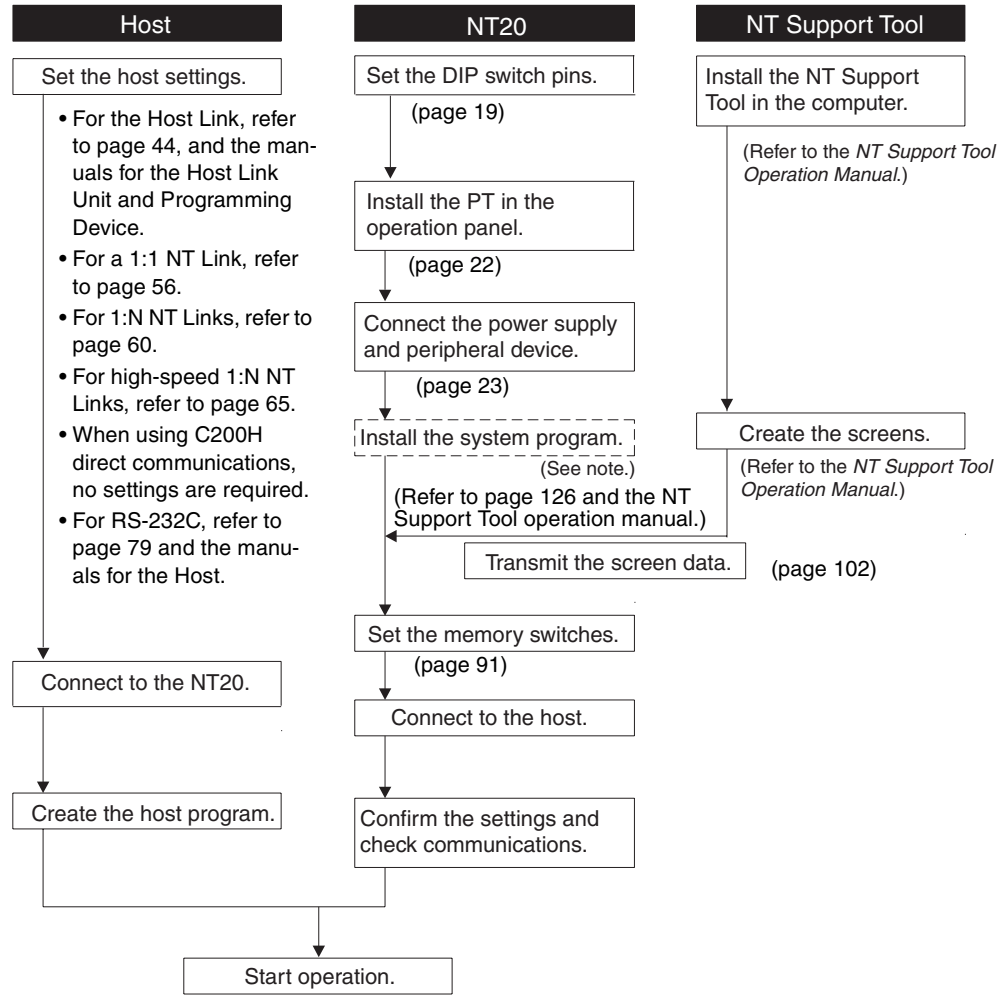

**Note** System program installation is only done in special circumstances, for example when changing the system program, or when recovering the original status of the installed program. This operation is not normally necessary.

Refer to the following manuals for the equipment and software.

Device or Software	Manual Title	Cat. No.
NT20	User's Manual	V091-E1-□
System Installer	NT-series Support Tool for Windows (Ver. 4.8) Operation Manual	V061-E1-□
NT Support Tool	NT-series Support Tool for Windows (Ver. 4.8) Operation Manual	V061-E1-□
PLC	SYSMAC CPM1 Operation Manual	W262-E1-□
	SYSMAC CPM1A Operation Manual	W317-E1-□
	SYSMAC CPM2A Operation Manual	W352-E1-□
	SYSMAC CPM2C Operation Manual	W356-E1-□
	SYSMAC C200H Operation Manual (for CPU01/03/11) (Programming)	W130-E1-□
	SYSMAC C200H Operation Manual (for CPU21/23/31) (Programming)	W217-E1-□
	SYSMAC C200HS Installation Guide	W236-E1-□
	SYSMAC C200HS Operation Manual (Programming)	W235-E1-□
	SYSMAC C200HX/HG/HE (-Z) Installation Guide	W302-E1-□
	SYSMAC C200HX/HG/HE Operation Manual	W303-E1-□
	SYSMAC C200HX/HG/HE-Z Operation Manual	W322-E1-□
	SYSMAC CQM1/CPM1/CPM1A/SRM1 Programming Manual	W228-E1-□
	SYSMAC CQM1H Operation Manual	W363-E1-□
	SYSMAC CVM1/CV500/CV1000/CV2000/CVM1 Operation Manual: Ladder Diagrams	W202-E1-□
	CS Series Programmable Controllers Operation Manual	W339-E1-□
	CJ Series CJ1G-CPU□□-E Programmable Controllers Operation Manual	W393-E1-□
	CS/CJ Series Programming Manual	W394-E1-□
CS/CJ Series Serial Communications Boards/Units Operation Manual	W336-E1-□	
SYSMAC CQM1H Series Serial Communications Board Operation Manual	W365-E1-□	
CompoBus Master Control Unit	SRM1 (-V2) Operation Manual	W318-E1-□
Programming Tools	SYSMAC Support Software Operation Manual: C-series PLCs	W248-E1-□
	SYSMAC Support Software Operation Manual: CVM1 PLCs	W249-E1-□
	SYSMAC CPT User Manual and Quick Start Guide	W332-E1-□ W333-E1-□
	CX-Programmer Ver. 4 User Manual	W425-E1-□
Host Link Unit/ Serial Communications Board	SYSMAC C Series Host Link Unit System Manual	W143-E1-□
	SYSMAC CVM1/CV Series Host Link Operation Manual	W205-E1-□
	SYSMAC C200HW-COM01 C200HW-COM02-V1 to C200HW-COM06-EV1 Communications Board Operation Manual	W304-E1-□



# SECTION 2

## Hardware Settings and Connections

This section describes the settings of the NT20, connections to a Host, and other hardware settings.

2-1	Description of Parts and Settings . . . . .	18
2-1-1	Description of Parts . . . . .	18
2-1-2	Operation Status DIP Switch Settings . . . . .	19
2-2	Installation . . . . .	21
2-2-1	Installation Environment . . . . .	21
2-2-2	Installation to the Operation Panel . . . . .	22
2-2-3	Power Supply Connection . . . . .	23
2-3	Connecting Link Adapters and RS-422A Converters . . . . .	24
2-3-1	Connecting an CJ1W-CIF11 RS-422A Converter . . . . .	24
2-3-2	Connecting an NT-AL001 Link Adapter . . . . .	28
2-4	Connecting the NT Support Tool . . . . .	35
2-5	Using a Memory Unit . . . . .	36
2-5-1	Installation Method . . . . .	37
2-5-2	Method of Use . . . . .	37
2-6	Connecting to the RS-232C Port at the Host . . . . .	44
2-6-1	Host Types and Settings . . . . .	44
2-6-2	Connecting Directly between RS-232C Ports . . . . .	69
2-7	Communicating with the PLC Using C200H Direct Communications . . . . .	73
2-7-1	Applicable PLC Units . . . . .	73
2-7-2	Connection Method . . . . .	73
2-7-3	Turning the Power ON/OFF When Using C200H Direct Communications . . . . .	77
2-8	Host Connections by RS-232C (NT20-ST128) . . . . .	79
2-8-1	Host Computer Communications Settings . . . . .	79
2-8-2	Connector Pin Arrangement . . . . .	79

**Note** On unpacking the NT20 and peripheral devices, check their external appearance and confirm that there is no damage. Also confirm that there is no abnormal noise when you shake the PT lightly.

## 2-1 Description of Parts and Settings

Before getting to the operation, confirm the names and functions of parts. Also set the DIP switches on the NT20.

### 2-1-1 Description of Parts

#### Front View

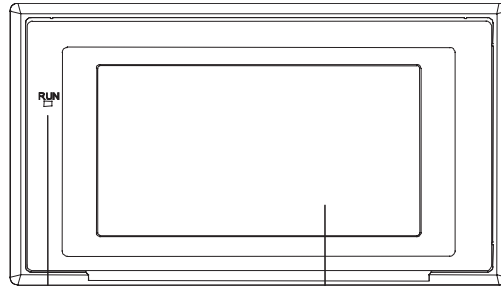

**RUN indicator**  
 • Lit green while the PT is in RUN mode.

Touch switches can be created in the desired locations on the display and used as lamps, input switches, and other functional objects.

**Note** The NT20 comes in two body colors.

- NT20-ST121-E: Ivory
- NT20-ST121B-E: Black
- NT20-ST128: Ivory
- NT20-ST128B: Black

#### Rear View

**Expansion interface connector**  
 When using an Expansion Interface Unit such as a Memory Unit, connect it here.

**Battery cover**  
 There is a battery holder beneath this cover. The Battery is not installed when the PT is shipped.

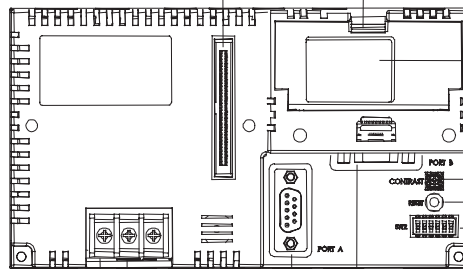

**Power input terminals**  
 Connect the power to the NT20 at these terminals

**Serial port A connector**  
 Connect this connector to a host or to a computer running Support Software. An RS-232C 9-pin connector is required. A CJ1W-CIF11 RS-422A Converter can be connected directly.

**Serial port B connector**  
 Connect this connector to communicate with a host. An RS-232C 9-pin connector is required. A CJ1W-CIF11 RS-422A Converter can be connected directly.

**Type name**  
**Contrast control**  
 Use a fine flat-blade screwdriver.

**Reset switch**  
**DIP switch**

## 2-1-2 Operation Status DIP Switch Settings

Set the NT20 operation status with the DIP switches located in the bottom right corner on the rear of the body.

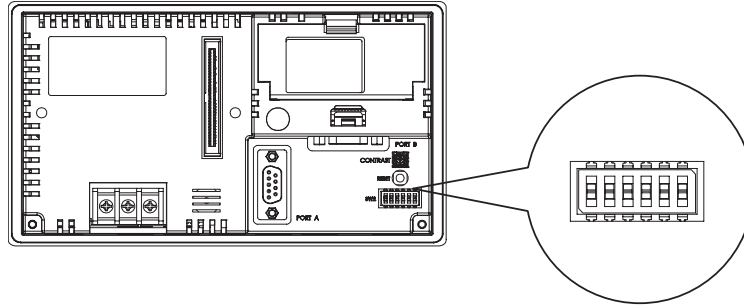

Switch #	Function	
SW2-1	Screen data forced initialize effective/ineffective <b>Note</b> When this switch is ON, SW2-4, SW2-5 and SW2-6 must be OFF.	
	ON	The NT20 will start in a special RUN mode in which the screen data memory is initialized. When it is started, the memory initialization menu will be displayed. For the initialization procedure, refer to <i>Section 3-4 Initializing Memory</i> .
	[OFF]	The NT20 will start in normal RUN mode.
SW2-2	Screen display language mode. DIP SW2-2 is used to indicate language selection. If it is turned ON, then display language will use English and the language parameter in memory SW is not selectable (User can't choose other language than English.) But if it is turned OFF, then user can choose other language through language parameter in memory SW.	
	[ON]	Messages are displayed in English.
	OFF	Language can be selected.
SW2-3	Switching to the System Menu enabled/disabled	
	ON	The System Menu cannot be displayed. If an error occurs during a start-up, the System Menu will be automatically displayed. However, "transfer mode" cannot be entered.
	[OFF]	The System Menu can be displayed.
SW2-4	Unused (Reserved for system use)	
SW2-5	System resource initialize <b>Note</b> When this switch is ON, SW2-1, SW2-4 and SW2-6 must be OFF.	
	ON	Effective
	[OFF]	Invalid
SW2-6	System program initialize <b>Note</b> When this switch is ON, SW2-1, SW2-4 and SW2-5 must be OFF.	
	ON	Effective
	[OFF]	Invalid

[ ] indicates factory setting.

**Caution** If the DIP switch settings have been changed when the NT20 is powered, reset the power to the NT20. The changes with the DIP switches become effective only after the power supply is reset.

- Note**
- (1) In addition to the DIP switches, set also the "communications type", "host link baud rate", etc. at the memory switches when host link/NT link is used.  
For these settings, refer to *Section 3-5 Setting the Conditions of Communications with the Host by Using the Memory Switches* (page 91).
  - (2) It may be necessary to change the DIP switch settings after installing the NT20 in an operation panel. Bear this in mind when deciding the installa-



tion position.

During work at the panel, take care to ensure that no metal scraps enter the unit.

## 2-2 Installation

Install the NT20 to the operation panel and connect the power to the NT20 as described below.

### 2-2-1 Installation Environment

Observe the following points when installing the PT in an operation panel.

 **Caution** Do not install the NT20 at sites subject to the following conditions. Otherwise, the product may malfunction.

- Severe temperature variations
- Temperatures or humidities outside the ranges stated in the specifications
- High humidity, condensation
- Splashing chemical agents
- Severe oil splashing
- Corrosive or flammable gases
- Strong vibrations or shocks
- Direct exposure to wind and rain (outdoor sites)
- Strong ultra-violet irradiation

Take adequate measures to ensure shielding if the NT20 is used at a location subject to any of the following conditions.

- Static electricity, or noise from other equipment
- Strong electric or magnetic fields
- Nearby power cables
- Potential exposure to radioactivity

 **Caution** Do not perform a withstand voltage test. Performing with stand voltage tests may result in malfunction.

### 2-2-2 Installation to the Operation Panel

The NT20 can be flush mounted to an operation panel.

Use the panel fittings and tools included in the product package and follow the procedure below.

**Caution** During work at the panel, take care to ensure that no metal scraps enter the unit. Otherwise, the product may malfunction.

**Note** The thickness of applicable operation panel is 1.6 mm to 4.8 mm. All fittings must be tightened uniformly to a torque of at least 0.5 to 0.6 N-cm in order to ensure water- and dust-resistance. The panel must not be soiled or warped, and must be able to support an installation that will remain secure and strong.

1. Open a hole, shown below, in the panel and install the NT20 from the front of the panel.

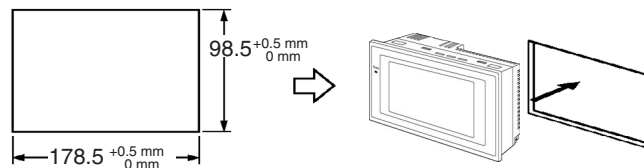

2. Attach the panel fittings at four positions, shown below, on the rear of the NT20.

Fit the hook of the fitting in the square hole in the body and tighten the screw with a Phillips head screwdriver while lightly pulling the fitting.

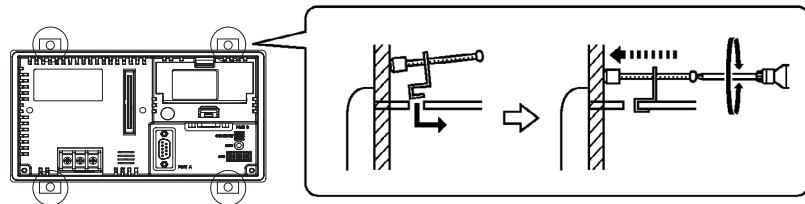

**Note** In order to ensure adequate water and dustproof performance, tighten the four panel fittings uniformly and make sure there are no gaps between the fittings and the NT20 panel.

### 2-2-3 Power Supply Connection

Connect a 24 VDC power supply to the power input terminals.

**⚠ Caution** Carefully check the wiring before turning ON the power.

**⚠ Caution** Do not connect AC power to the DC terminals. Incorrect wiring may result in burning.

- Note**
- (1) Depending on how the power is turned ON/OFF, the entire system may stop. Follow the correct procedure when turning the power ON/OFF. Otherwise the system may operate unpredictably.
  - (2) Use DC power supplies with low voltage fluctuation. An incorrect power supply may result in malfunctions.
  - (3) Do not perform a dielectric strength test. Otherwise, the product may malfunction.
  - (4) If complying with EC directives (low voltage directives), use a power supply with reinforced insulation (compliance with EC directives is planned for June 1998).

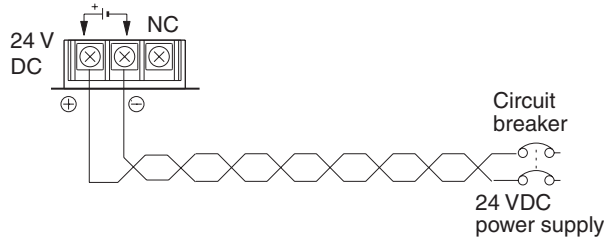

#### Power Supply

The applicable power supply specifications are as follows.

Item	Value
Power supply	24 VDC
Allowable power supply voltage fluctuation range	20.4 VDC to 27.6 VDC (24 VDC -15%, +15%)
Power supply voltage capacity	10 W or more

#### Parts Used for Connection

**Note** For the connection to the power supply terminal block, use stranded wire of 2 mm<sup>2</sup> or greater cross sectional Area (14 AWG stranded wire) and M3.5 size crimp terminals.

Tighten the screws on the terminal block to a torque of 0.8 N·m. Otherwise the product may malfunction.

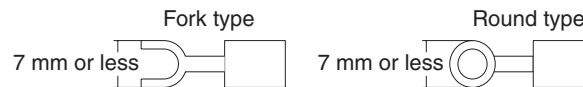

#### Recommended Terminals

Maker	Fork type	Round type	Stranded wire size
Japan Solderless Terminal MFG	2-YS3A	2-3.5	2.0 to 2.63 mm <sup>2</sup> (14 to 13 AWG)
Fuji Terminal	2-YAS3.5	V2-S3.5	
Nichifu Terminal	2Y-3.5	2-3.5	

## 2-3 Connecting Link Adapters and RS-422A Converters

This section describes the installation of the NT-AL001 Link Adapter and CJ1W-CIF11 RS-422A Converter, including the external dimensions, procedure for mounting and removal, and specifications. Refer to this information when designing the control panel. For further details, refer to the *Instruction Sheet* supplied with the NT-AL001 or CJ1W-CIF11.

### 2-3-1 Connecting an CJ1W-CIF11 RS-422A Converter

The CJ1W-CIF11 RS-422A Converter connects directly to the NT20's serial port A or B and converts RS-232C communications to RS-422A or RS-485. The NT20 supplies power to the RS-422A Converter through pin 6 of the RS-232C connector, so an external power supply is not required.

- Note**
1. The RS-232C connector is not insulated from the RS-422A/RS-485 connector within the CJ1W-CIF11 RS-422A Converter. If there are concerns about differences in ground potential or noise, we recommend using the NT-AL001 Link Adapter.
  2. Always turn OFF the NT20's power supply before installing/removing a RS-422A Converter or connecting/disconnecting cables.
  3. Always discharge any static electricity by touching a grounded object before installing the RS-422A Converter or connecting cables.

## Specifications

### General Specifications

Item	Specification	
Dimensions	18.2 × 34.0 × 38.8 mm (W × H × D)	
Weight	20 g max.	
Ambient operating temperature	0 to 55°C	
Ambient storage temperature	-20 to 75°C	
Ambient operating humidity	10% to 90% (with no condensation)	
Rated power supply voltage	5 V	(Supplied from pin 6 of the RS-232C connector.)
Current consumption	40 mA max.	
Operating atmosphere	No corrosive gases	
Vibration resistance	Same as NT20 Series.	
Shock resistance	Same as NT20 Series.	
Isolation method	Not isolated	
Maximum communications distance	50 m (Use the NT-AL001 if the total communications distance exceeds 50 m.)	

### RS-232C Connector

Connector Pin Arrangement for RS-232C Port

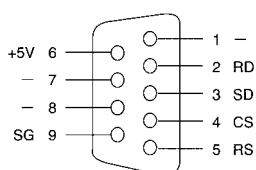

Pin number	Signal
1	FG
2	RD
3	SD
4	CS
5	RS
6	+5V
7, 8	NC
9	SG
Hood	NC

**Note** The hood will have the same electrical potential as the connector on the other end of the cable.

**RS-422A/485 Terminal Block**

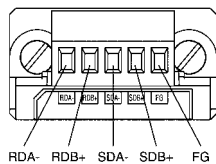

Signal
RDA-
RDB+
SDA-
SDB+
FG

**Block Diagram**

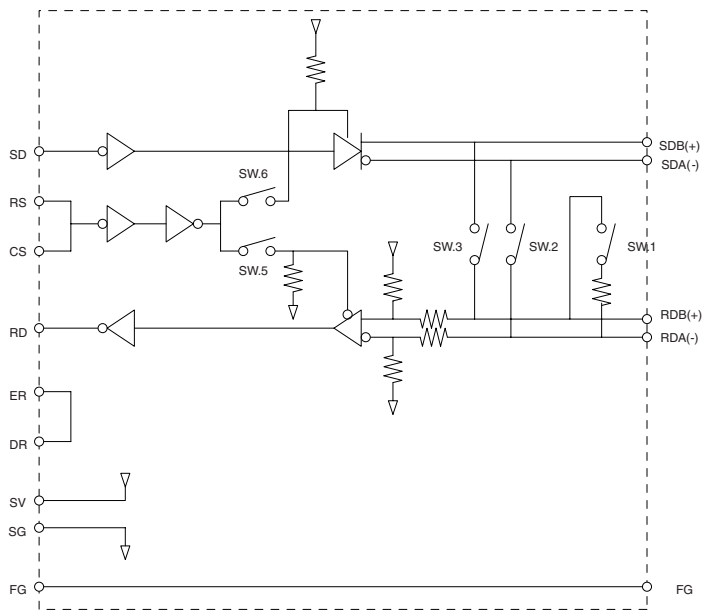

**DIP Switch Settings**

Pin number	Function	ON	OFF
1	Terminating resistance	With (at both ends of the communications path)	Without
2	Two-wire/four-wire method selection (See note 1.)	Two-wire method	Four-wire method
3	Two-wire/four-wire method selection (See note 1.)	Two-wire method	Four-wire method
4	Not used.	---	---
5	Selection of RS control for RD (See note 2.)	With RS control	Without RS control (always ready to receive)
6	Selection of RS control for SD (See note 3.)	With RS control	Without RS control (always ready to send)

**Note** (1) Set pins 2 and 3 to the same setting. (ON for the two-wire method or OFF for the four-wire method.)  
 (2) To prohibit echoback, set pin 5 to ON (with RS control).

- (3) When connecting to several devices using the four-wire method in a 1:N connection, set pin 6 to ON (with RS control). When connecting using the two-wire method, set pin 6 to ON (with RS control).

**Dimensions**

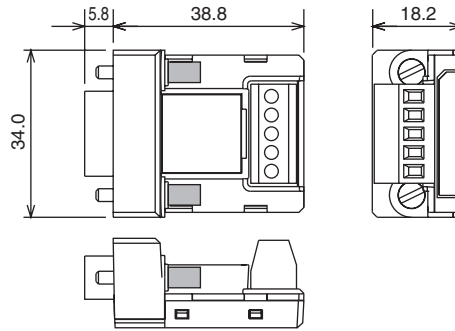

**DIP Switch Settings, Wiring, and Installation**

The DIP switch settings must be changed to perform communications according to settings other than the default settings.

1. Remove the DIP switch cover using a flat-bladed screwdriver in the way shown below.

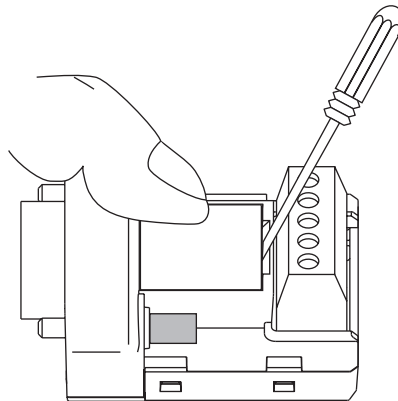

**Note** Press the cover gently while removing it to prevent it from popping out suddenly.

2. Using a fine pair of tweezers or other tool with a fine point, change the settings of the DIP switch pins to match the desired communications conditions.
3. Be sure to remount the cover after finishing the DIP switch settings.

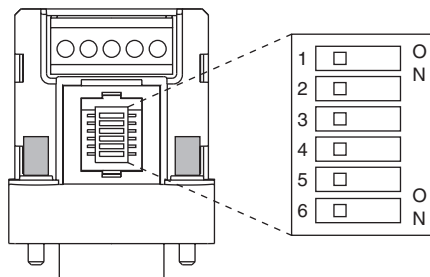

All the pins are factory-set to OFF.

**Wiring the RS-422A/485 Terminal Block**

- Use either two-wire or four-wire shielded cable.  
Recommended cable: CO-HC-ESV-3P×7/0.2 (Hirakawa Hewtech)

- Connect the shield wire at both ends of the cable carrying RS-422A/485 signals to ground, and ground the ground terminal on the Power Supply Unit of the CPU or Expansion Rack to 100 Ω max.

1. Taking care not to damage the shield, strip between 30 and 80 mm of sheath off the end of the cable.

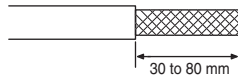

2. Carefully twist the shield mesh together to form a single wire, and carefully cut off the material surrounding the signal wires and any unnecessary signal wires.

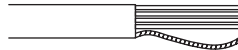

3. Strip the sheath off the signal wires to a length sufficient to attach crimp terminals. Apply vinyl tape or heat-shrinking tube to the sheathes and stripped parts of communications lines.



4. Attach stick-type crimp terminals to ends of the signal lines and crimp them using a crimp tool.

- Recommend crimp terminals:  
Phoenix Contact  
AI Series  
AI-0.5-8WH-B (serial number: 3201369)
- Recommended crimp tool:  
Phoenix Contact ZA3

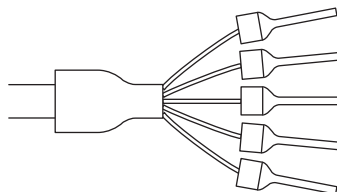

With four-wire cables, insert two signal lines into each crimp terminal together before crimping.

- Recommend crimp terminals:  
Phoenix Contact  
AI Series  
AI-TWIN2×0.5-8WH (serial number: 3200933)
- Recommended crimp tool:  
Phoenix Contact  
UD6 (serial number: 1204436)

5. Connect the signal lines and the shield line to the RS-422A/485 terminal block.



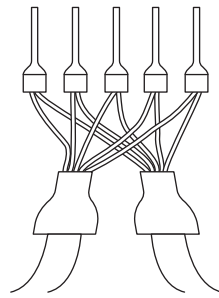

**RS-422A/485 Cable Shield Connections**

When using the CJ1W-CIF11 (with or without the NT-AL001), connect the signal lines, shields, and grounds as shown in the following diagram.

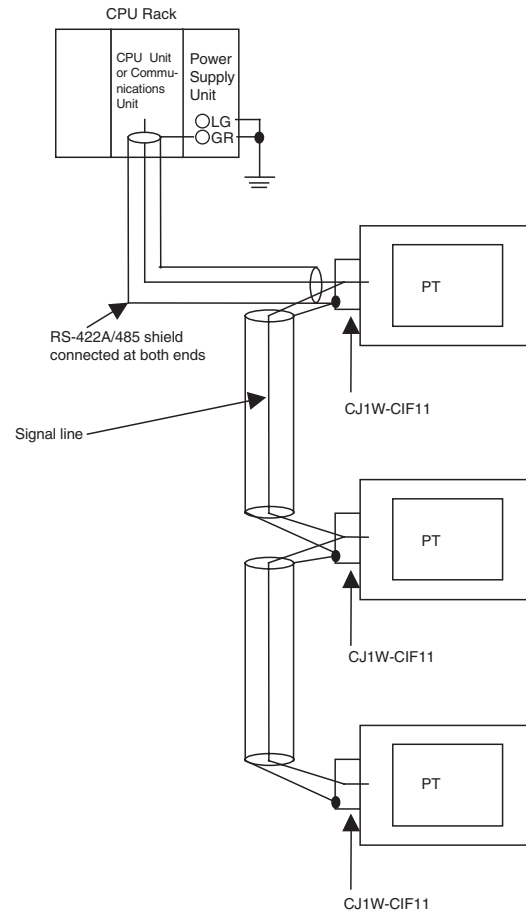

**2-3-2 Connecting an NT-AL001 Link Adapter**

The NS-AL001 Link Adapter connects to serial port A or B of the NT20 with an RS-232C cable and converts the RS-232C communications to RS-422A or RS-485. (Serial ports A and B cannot be used simultaneously.)

The NT20 supplies +5 V power (150 mA max.) to the Link Adapter through pin 6 of the RS-232C connector, so an external power supply is not required.

- Note**
1. The RS-232C connector is insulated from the RS-422A/RS-485 connector within the NT-AL001 Link Adapter.
  2. Always turn OFF the NT20's power supply before installing/removing a Link Adapter or connecting/disconnecting cables.

**Dimensions**

The following diagram shows the dimensions of the NT-AL001 Link Adapter. All dimensions are in mm.

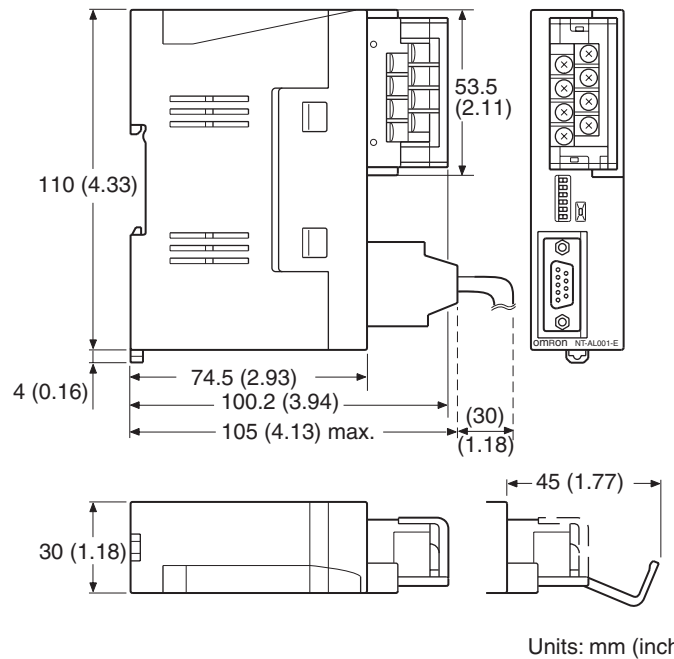

**Dimensions with RS-422A Terminal Block Cover Closed**

30 × 114 × 100.2 mm (W × H × D)

**Dimensions with RS-422A Terminal Block Cover Open**

30 × 114 × 119.5 mm (W × H × D)

**Installation and Removal**

The NT-AL001 Link Adapter can be mounted on a DIN Track or in a control panel. The Link Adapter's RS-422A terminal block can be removed easily.

**Mounting to a DIN Track**

Latch the hook (a) on the rear of the Link Adapter onto the top edge of the DIN Track, and pivot the Link Adapter downwards (b) as shown in the diagram below.

Next, fit End Plates at the right and left of the Link Adapter to secure it so that it cannot shift laterally.

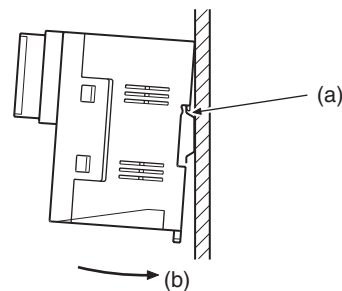

**Removal from a DIN Track**

Remove the End Plates from the right and left of the Link Adapter, insert a flat blade screwdriver into the catch at the bottom of the Link Adapter, and pull it down to release the catch.

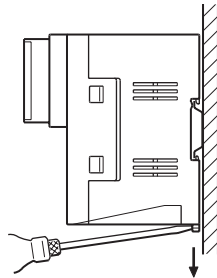

**Mounting to a Control Panel**

The control panel must be at least 2 mm (5/64 inch) thick. Drill two mounting screw holes in a control panel and secure the Link Adapter with screws.

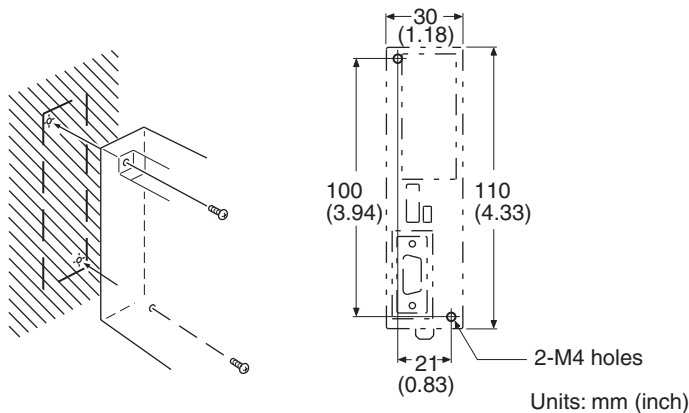

**Note** The control panel must be at least 2 mm (5/64 inch) thick for a secure and strong mount.

**Specifications**

The following tables list the NT-AL001 Link Adapter’s general and communications specifications.

**General Specifications**

Item		Specification
Dimensions		With RS-422A terminal block cover closed: 30 × 114 × 100.2 mm (W × H × D) With RS-422A terminal block cover open: 30 × 114 × 119.5 mm (W × H × D)
Weight		200 g max.
Ambient temperature	Operating	0 to 55°C
	Storage	-20 to 75°C
Operating ambient humidity		10% to 90% (with no condensation)
Rated power supply voltage		+5 V ± 10% (through pin 6 of the RS-232C connector)
Rated power supply current		150 mA max.
Inrush current		0.8 A max.
Insulation resistance		20 MΩ min., measured between the RS-422A terminal signal lines and FG terminal (at 500 VDC)

Item	Specification
Dielectric strength	1,500 VAC for 1 minute between the RS-422A terminal signal lines and the FG terminal Leakage current: 10 mA max.
Operating environment	No corrosive gases
Vibration resistance	Conforms to JIS C0911, 60 minutes each in X, Y, and Z directions
Shock resistance	Conforms to JIS C0912, 147 m/s <sup>2</sup> , 3 times each in X, Y, and Z directions

**Communications Specifications (RS-232C Interface)**

Item	Specification
Baud rate	115.2k bps max.
Transmission distance	2 m max.
Connector	9-pin D-SUB connector (female)

**Communications Specifications (RS-422A/485 Interface)**

Item	Specification
Baud rate	115.2k bps max. (depends on the RS-232C baud rate)
Transmission distance	500 m max.
Terminal block configuration	8-terminal detachable terminal block, M3.0

DIP Switch Settings

The NT-AL001 Link Adapter has a 6-pin DIP switch that sets the RS-422A/RS-485 communications conditions. Set the DIP switch before connecting the communications cable.

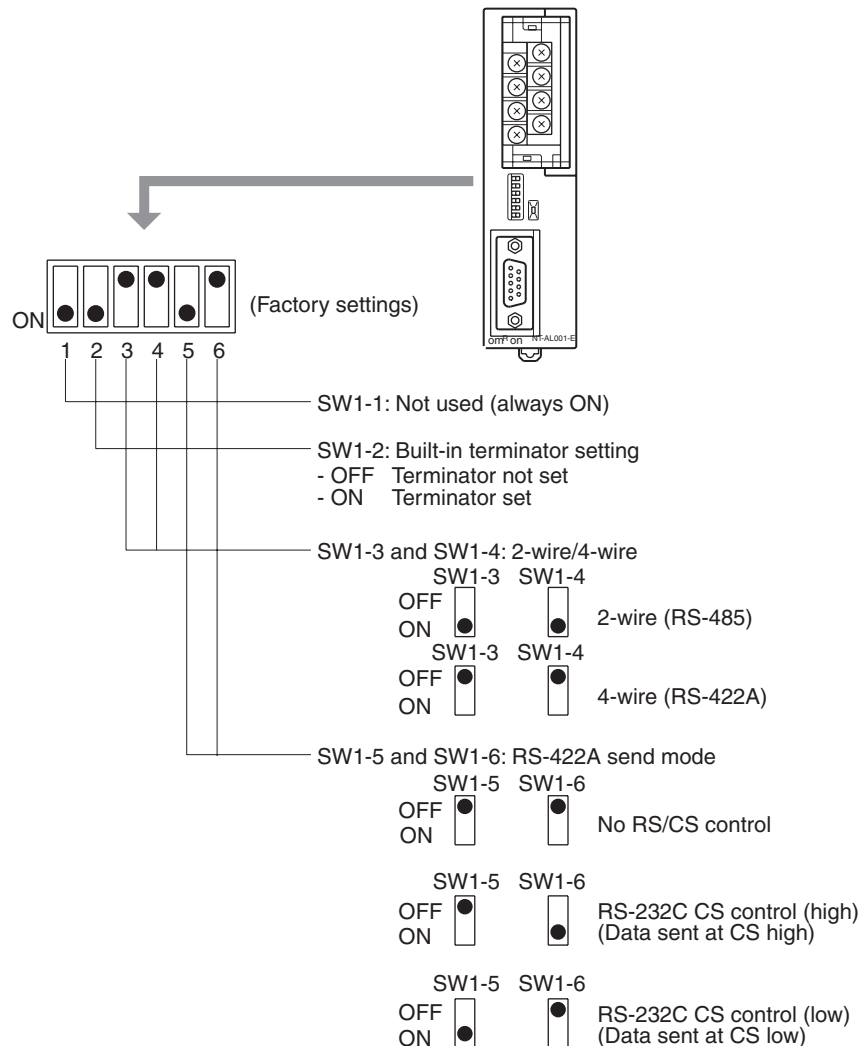

When using Host Link or 1:1 NT Link communications, set the RS-422A send mode to “no RS/CS control” by turn OFF both SW1-5 and SW1-6.

When using 1:N NT Link communications (standard or high-speed), set the communications mode to “RS/CS control” by turning ON either pin SW1-5 or SW1-6.

- Note**
1. Do not turn ON both SW1-5 and SW1-6 at the same time. This may damage internal circuits.
  2. The power supply to the device supplying +5 V must be turned OFF before starting wiring work.
  3. Before connecting the RS-232C cable and turning ON the power to an RS-232C device such as a PT (i.e., turning ON the power to the Link Adapter), check that the cable is wired correctly and that the DIP switch settings are correct. If the power is turned ON and there is a wiring fault, the internal circuits of the Link Adapter or the RS-232C device may be damaged.

- When the Link Adapter is connected to a C200HX/HG/HE (-ZE), CQM1H, CS1G/H, CS1G/H-H, or CJ1G model of OMRON PLC as an RS-422A device, set pins SW1-5 and SW1-6 as indicated below.

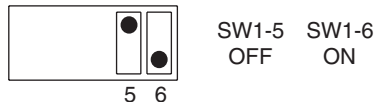

**Terminal Pin Allocation**

The NT-AL001 Link Adapter has a terminal block for an RS-422A/485 interface connection and a connector for an RS-232C interface connection. The pin allocations for the RS-422A/485 terminal block and the RS-232C connector are as follows.

**RS-422A/485 Terminal Block**

The CSB and CSA signals are for specialized applications.

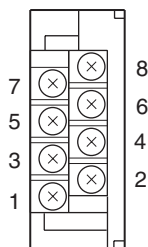

Pin	Signal name	Code	Signal direction (Link Adapter ↔ Device)
8	Request to send (-)	CSA	Link Adapter → RS-422A/485 Device
7	Request to send (+)	CSB	Link Adapter → RS-422A/485 Device
6	Receive data (-)	RDA	Link Adapter ← RS-422A/485 Device
5	Receive data (+)	RDB	Link Adapter ← RS-422A/485 Device
4	Send data (-)	SDA	Link Adapter → RS-422A/485 Device
3	Send data (+)	SDB	Link Adapter → RS-422A/485 Device
2	Signal ground	SG (GND)	---
1	Functional ground		---

**Compatible Crimp Terminals**

Use crimp terminals for M3 screws.

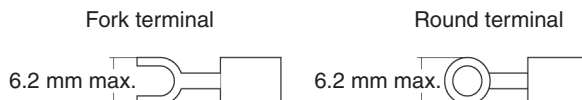

Manufacturer	Style	Model	Compatible wire
J.S.T. Mfg Co., Ltd.	Fork	V1.25-N3A	AWG22 to AWG16 (0.25 to 1.65 mm <sup>2</sup> )
	Round	V1.25-MS3	
Molex	Fork	VSY1.25-3.5L	AWG22 to AWG16 (0.3 to 1.65 mm <sup>2</sup> )
	Round	RAV1.25-3	

**RS-232C Connector**

The connector hood is connected to the RS-422A terminal block's frame ground terminal.

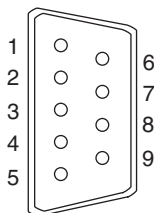

Pin	Signal name	Code	Signal direction (RS-232C Device ↔ Link Adapter)
1	Not used	---	---
2	Send data	SD	RS-232C Device ← Link Adapter
3	Receive data	RD	RS-232C Device → Link Adapter
4	Request to send (shorted to CS internally)	RS	RS-232C Device ← Link Adapter
5	Clear to send (shorted to RS internally)	CS	RS-232C Device → Link Adapter
6	+5 V (150 mA) input for Link Adapter	+5 V	RS-232C Device → Link Adapter
7	Data set ready (shorted to ER internally)	DR	RS-232C Device → Link Adapter

Pin	Signal name	Code	Signal direction (RS-232C Device ↔ Link Adapter)
8	Data terminal ready (shorted to DR internally)	ER	RS-232C Device ← Link Adapter
9	Signal ground	SG	---

**Block Diagram**

The following diagram shows the internal block diagram of the NT-AL001 Link Adapter. Refer to this diagram only when wiring custom cables or connecting devices with special interfaces.

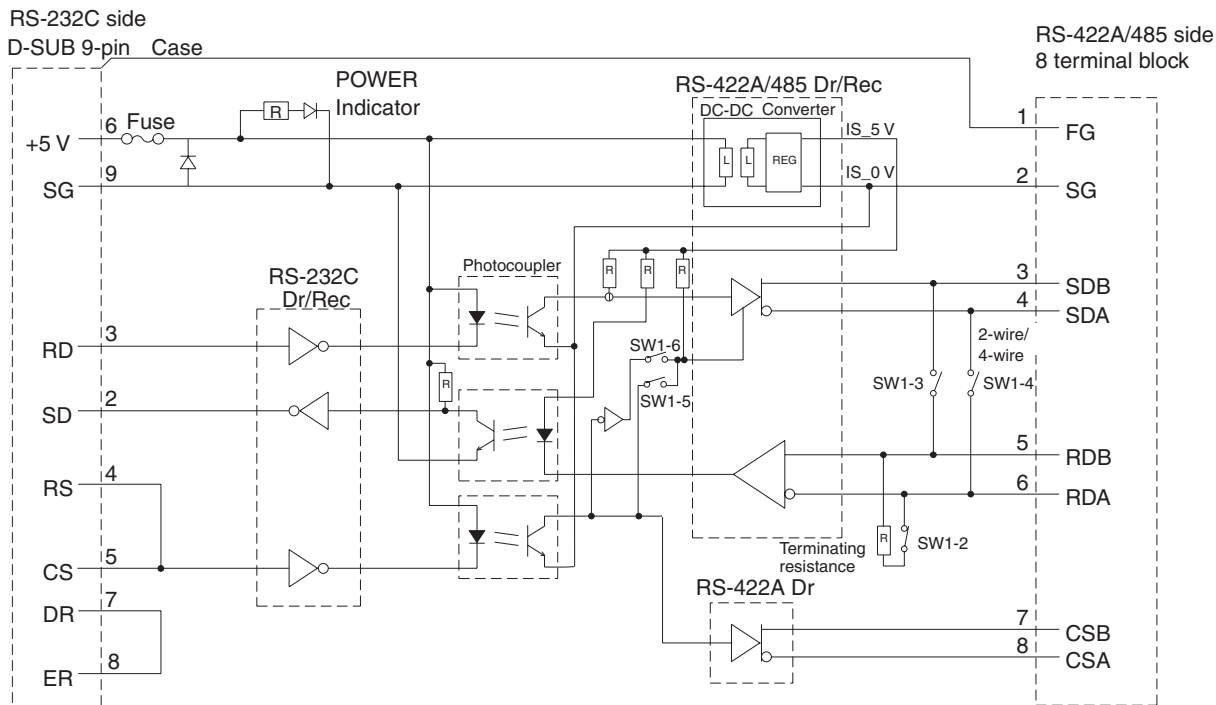

**RS-422A/485 Cable Shield Connections**

When using RS-422A or RS-485 cables for long-distance communications, do not ground the shield at both ends of the communications line because large currents can flow through the shield due to the difference in potential at the two grounding points. We recommend grounding the shield at one end, as shown in the following diagram.

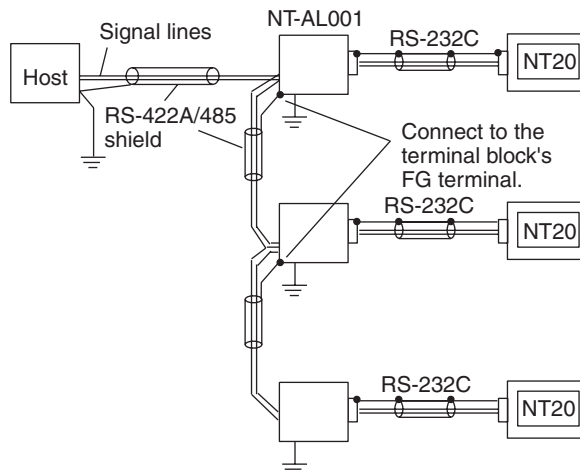

## 2-4 Connecting the NT Support Tool

In order to install the system program in the NT20, or to transmit screen data created with the NT Support Tool to the NT20, the NT20 must be connected to a personal computer with an RS-232C cable.

The NT20 connects with the RS-232C cable from a personal computer at serial port A. When the host is connected at serial port B, the connection with the host can be maintained as it is while the NT20 is connected to the RS-232C cable from a personal computer.

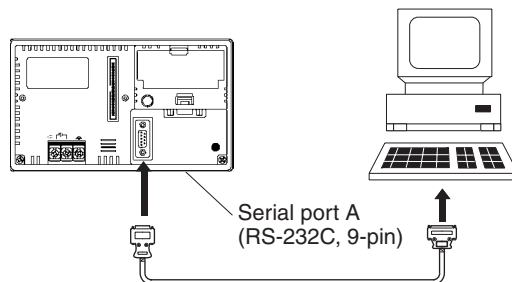

### **Communications Conditions**

The communications conditions are automatically set when the system installer and NT Support Tool are started.

### **Recommended Connector Cable**

Use the cable indicated below.

- CV500-CN228 (length: 2 m), made by OMRON (D-SUB 9-pin, male ↔ D-SUB 25-pin, male)
- XW2Z-S001 (conversion cable), made by OMRON (D-SUB 25-pin, female ↔ half pitch 14-pin, male)
- XW2Z-S002 (length: 2 m), made by OMRON (D-SUB 9-pin, male ↔ D-SUB 9-pin, female)

For details on making a connector cable, refer to *Appendix E Making the Cable for Connecting a Personal Computer* on page 267.



## 2-5 Using a Memory Unit

This section explains how to use a Memory Unit with the NT20. By installing a Memory Unit (NT-MF261) on the NT20, the system program or the screen data in the NT20 can be recorded (backed up) in the Memory Unit.

In addition, the system program or the screen data in the Memory Unit can be automatically read into the NT20 when it starts up. This means that system program and screen data can be changed easily at the operation site without connecting to the NT Support Tool.

The data in the Memory Unit is retained without backup by a battery or other means.

In systems where there are frequent setup changes, by preparing a number of Memory Units in advance and recording screen data in them according to the control performed in each case, the NT20 screen data can be changed simply by installing the Memory Unit, without connecting to the NT Support Tool.

Even if NT20 is replaced, the previous status can be maintained simply by installing the Memory Unit that retains the system program and screen data of the previous NT20.

By using the following combinations, data can be stored (backed up) to a Memory Unit.

- Screen data for two PTs.
- System program for two PTs.
- System program and screen data for one PT.

One Memory Unit can store the screen data for two PTs.

- Note**
- (1) Make sure that the power supply to the PT is OFF before connecting or disconnecting a Memory Unit. After mounting a Memory Unit, be sure to tighten its two screws. Otherwise the product may malfunction.
  - (2) During data transmission, do not turn OFF the power supply to the NT20.
  - (3) Do not touch the PCB (printed circuit board) with bare hands. Also, discharge any static electricity by touching a grounded object before connecting or disconnecting a Memory Unit. Static electricity may cause the components to malfunction.
  - (4) Be sure that the combination of the system program and screen data is correct in the NT20 before transferring data from the Memory Unit to the NT20. If the system program and screen data are not combined correctly, unexpected operation may result.

**Reference:**

- When a Memory Unit is mounted, the NT20 cannot be set to the operating status. On completion of data transmission with a Memory Unit, always disconnect the Memory Unit from the NT20 before starting NT20 operation.
- One Memory Unit can store a system program for up to two PTs of different models. In order to transmit a system program from the Memory Unit to the NT20, the system program must be compatible to the target PT model.
- The status of memory switch settings can be recorded to the Memory Unit besides screen data. When the data in the Memory Unit is written into the NT20, make sure that these settings can be adapted to the NT20 used before transmission.

### 2-5-1 Installation Method

Install the Memory Unit (NT-MF261) at the expansion interface connector at the rear of the NT20 as shown in the figure below.

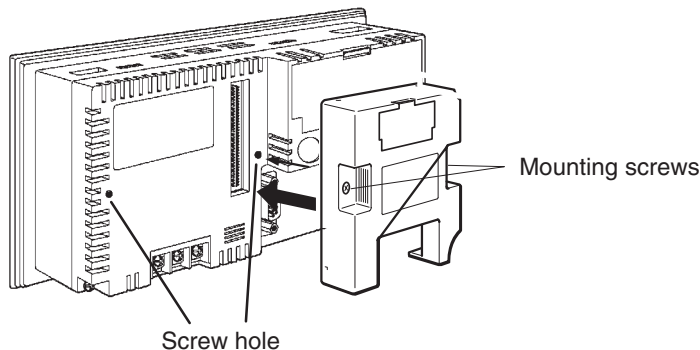

### 2-5-2 Method of Use

As shown in the figure below, a Memory Unit has 2 four-pin DIP switches, and the operation is determined by the DIP switch settings at startup.

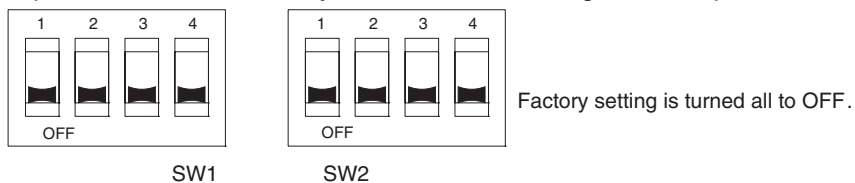

**Note** Always confirm that the power to the NT20 is OFF before setting the DIP switches.

#### DIP Switch Functions

The functions of the DIP switches on the Memory Unit are indicated in the table below.

##### SW1

Pin	Function	
SW1-1	Automatic transmission (writing from the Memory Unit to the PT)	OFF: Not executed ON: Executed
SW1-2	Automatic transmission (writing from the PT to the Memory Unit)	OFF: Not executed ON: Executed
SW1-3	Manual transmission (Direction of transmission and bank used selected at the PT touch panel)	OFF: Not executed ON: Executed
SW1-4	Data type to transfer	OFF: Screen data ON: System program

##### SW2

Pin	Function	
SW2-1	Disable/enable writing to PT	OFF: Disable ON: Enable
SW2-2	Disable/enable writing to the Memory Unit	OFF: Disable ON: Enabled
SW2-3	Area (bank) selection of automatic transmission (See note.)	OFF: Bank 0 ON: Bank 1
SW2-4	System/Screen simultaneous transmission	OFF: Disable ON: Enable

**Note** The Memory Unit stores system program or screen data for one PT in each of Areas (bank 0, bank 1). (The total data storage is for two PTs.) SW2-3 sets which of these two banks is used for automatic transmission.

**Reference:**

- In the following cases, a mode setting error occurs.
  - More than one of the SW1-1 to SW1-3 switches are set to ON.
  - None of the SW1-1 to SW1-3 switches are set to ON.
- In the following case, a protect setting error occurs.  
Transmitting to the write destination has been disabled by the setting for SW2-1 or SW2-2.
- In the following cases, a data transmission error occurs.
  - An attempt is made to transmit data other than the system program to PT System Program Area.
  - An attempt is made to transmit the system program to PT Screen Data Area.
- For details on mode setting errors and protect setting errors, refer to *Errors When Using a Memory Unit* (page 42).

**Writing Screen Data to a Memory Unit Using Automatic Transmission (PT to Memory Unit)**

In this mode, system program or the screen data in the NT20 is forcibly written to the Memory Unit irrespective of the setting status of the NT20.

This mode is convenient if the touch panel is broken and touch switch operation is not possible, or if someone unfamiliar with touch switch operation at the operation site is using the system.

**Reference:**

When screen data is written to the Memory Unit, the data that has been stored in the specified Area up until that point is lost (if the data is written into only one Bank, the other Bank will not be affected).

**Method of Execution**

Use the following procedure to write the system program or screen data in the NT20 to the Memory Unit by automatic transmission.

- 1,2,3...**
1. Check that the power supply to the NT20 is OFF, then set the DIP switches of the Memory Unit as follows after installing Memory Unit to NT20.

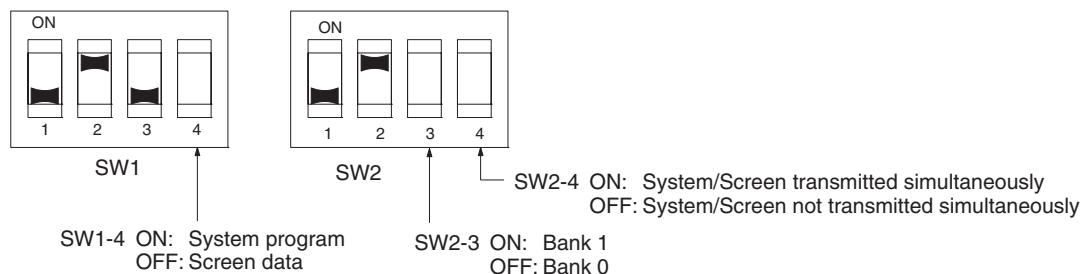

It is not strictly necessary to set SW2-1 to OFF (to disable writing to the PT), but it is recommended to do so to avoid loss of data in the event of operating errors.

**Reference:**

- Setting SW2-4 to ON (System/Screen transmitted simultaneously) disables the setting of SW1-4.
- Setting SW2-4 to ON (System/Screen transmitted simultaneously) disables the setting of SW2-3, writes the system program into bank 0, and the screen data into bank 1 at all times.

- Turn the NT20 power ON.

The screen data is automatically written into the Memory Unit. The screen data in the NT20 is preserved.

The messages Preparing, Transmitting, Verifying, and Finished are displayed on the screen according to the progress of data writing.

At the same time, the progress of the data writing status is displayed by the means of the number of bytes and blocks (1 bank = 16 block = 1024k byte).

RUN Indicator operates as follows according to the processing status.

Preparing: flashes at intervals of 1 second

Transmitting: flashes at intervals of 0.5 second

Verifying: flashes at intervals of 0.5 second

Finished: lights up

- Turn the NT20 power OFF, remove the Memory Unit.

To operate NT20 continuously, turn the NT20 power back ON.

**Writing Screen Data to the PT Using Automatic Transmission (Memory Unit to PT)**

In this mode, the system program or screen data in the Memory Unit is forcibly written to NT20 irrespective of the setting status of the NT20.

Since data transmission by this method is faster than when the NT Support Tool or system installer is used, it can save a lot of time. When transmitting the same system program or screen data to multiple NT20, this mode becomes convenient.

**Reference:**

When data is written to the NT20, the data that has been stored up until that point is lost. When the system program is changed, the operation of NT20 also changes.

**Method of Execution**

Use the following procedure to write the screen data in Memory Unit to the NT20 by automatic transmission.

- 1,2,3...**
- Check that the NT20 power is OFF, then set the DIP switches on the Memory Unit as follows after installing Memory Unit to NT20.

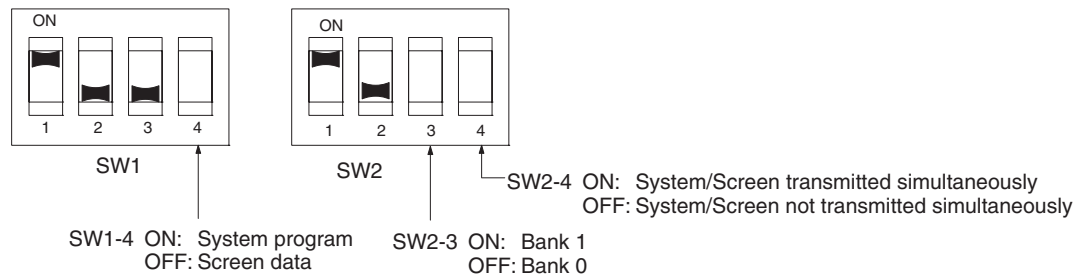

It is not strictly necessary to set SW2-2 to OFF (to disable writing to the Memory Unit), but it is recommended to do so to avoid loss of data in the event of operating errors.

**Reference:**

- Setting SW2-4 to ON (System/Screen transmitted simultaneously) disables the setting of SW1-4.
- Setting SW2-4 to ON (System/Screen transmitted simultaneously) disables the setting of SW2-3. In this case, the data transmission becomes possible only if the data inside Memory Unit is in either of following combinations.

Bank 0: system program, Bank 1: other than system program

Bank 0: other than system program, Bank 1: system program

If the combination is not as listed above, a data transmitting error occurs.

- When writing the system program into the NT20, the type of system program inside Memory Unit and the PT model must correspond.
2. Turn the NT20 power ON.

The screen data is automatically written into the PT.

The messages Preparing, Transmitting, Verifying and Finished are displayed on the screen according to the progress of data writing.

At the same time, the progress of data writing status is displayed by the means of the number of bytes and blocks (1 bank = 16 block = 1024k byte).

The RUN Indicator operates as follows according to the processing status.

Preparing: flashes at intervals of 1 second

Transmitting: flashes at intervals of 0.5 second

Verifying: flashes at intervals of 0.5 second

Finished: lights up

3. Turn the NT20 power OFF, remove the Memory Unit.

To operate NT20 continuously, turn the NT20 power back ON.

### Reading and Writing Data by Manual Transmission

In this method, the direction of transmission and Area of the Memory Unit used are set by touch switch operations at the NT20. Transmission can be executed while checking the settings.

**Reference:**

When data is written to the NT20 or Memory Unit, the data that has been stored up until that point is lost.

#### ■ Method of Execution

Use the following procedure to write screen data using manual transmission.

1,2,3...

1. Check that the NT20 power is OFF, then set the DIP switches on the Memory Unit as follows.

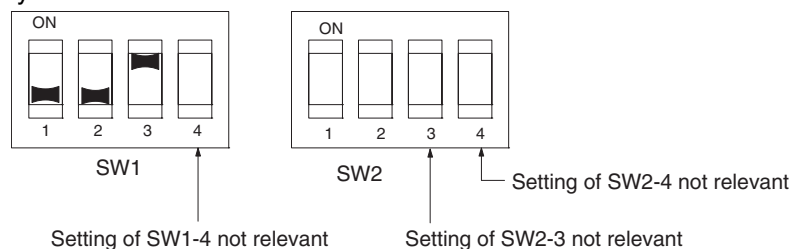

In order to avoid loss of data in the event of operating errors, it is advisable to set SW2-1 and SW2-2 so as to disable writing to the Unit from which the data is to be read.

2. Turn the NT20 power ON.  
Display language select screen appears.

- Press the Japanese or English touch switches to select the display language.

The screen shown below is displayed.



**Current PT Screen Data, System**

The first line: System program name and version for the system program inside the PT.

The second line: Resource name and version for the resource inside the PT.

**Current PT Screen Data, Screen**

The comment for the screen data in the NT20 is displayed here.

**Current Memory Unit Screen Data**

- System Program:

The first line: System program name and version data for the system program inside the Memory Unit.

The second line: Resource name and version for the resource inside the Memory Unit.

- Screen Data:

The comment for the screen data in the NT20 is displayed here.

The available transmitting destinations are altered depending on the settings of the source of transmitting as described in the table below

Source	Description
[PT]screen	
[PT]system	
[PT]system/screen	[Memory Unit] Bank 0/1 (fixed)
[Memory Unit] Bank 0	<ul style="list-style-type: none"> <li>If system program is selected [PT]system (fixed)</li> <li>If screen data is selected [PT]screen (fixed)</li> </ul>
[Memory Unit] Bank 1	
[Memory Unit] Bank 0/1	[PT]system/screen (fixed)

**Reference:**

- When transmitting the system program and screen data simultaneously from the PT to the Memory Unit, the setting of banks is Bank 0: system program, Bank 1: screen data, and when transmitting them from the Memory Unit to the PT, either of the following combinations must be used.
  - Bank 0: system program, Bank 1: other than system program
  - Bank 0: other than system program, Bank 1: system program
- When writing the system program into the NT20, the type of system program inside Memory Unit and the PT model must correspond.

## 4. Press Execute.

The messages Preparing, Transmitting, Verifying, and Finished are displayed according to the progress of data transmission. At the same time, the progress of data transmitting status is displayed by the means of the number of bytes and blocks (1 bank = 16 block = 1024k byte).

When the data transmission is operated manually, RUN Indicator remains OFF.

## 5. Turn the NT20 power OFF, remove the Memory Unit, then turn the NT20 power back ON.

**Errors When Using a Memory Unit**

If an error occurs when using the Memory Unit, the NT20 operates as follows

- Details on the error and remedial action are displayed on the screen.

Each screen has touch switches to change the display language from one to the other. When the manual data transmission is operating, the content of error and remedial action are shown with selected language. When the automatic transmission is operating, it is displayed in Japanese.

- The continuous buzzer sounds.
- The RUN Indicator flashes.

If a protect setting error occurs when executing manual transmission, it is possible to return to the Memory Unit manual transmission screen by pressing the OK touch switch, but in the case of other errors, the status described above remains in effect until the NT20 power is turned OFF or reset.

When an error occurs, take remedial action by referring to the table below.

Error	Probable Cause	Remedial Action
Mode setting error	DIP Switch pins SW1-1 to SW1-3 are all OFF, or more than one is ON.	Turn the NT20 power OFF, set the Memory Unit DIP switches correctly, then turn the NT20 power back ON.
Protect setting error (automatic transmission)	Writing to the data write destination has been prohibited by the setting of SW2-1 or SW2-2.	Turn the NT20 power OFF, set the Memory Unit DIP switches correctly, then turn the NT20 power back ON.
Protect setting error (manual transmission)	Writing to the data write destination has been prohibited by the setting of SW2-1 or SW2-2.	Perform either of the following procedures. <ul style="list-style-type: none"> <li>• Press the OK touch switch to return to the Memory Unit manual transmission screen, make the correct settings, then try again.</li> <li>• Turn the NT20 power OFF, correct the DIP switches settings of the Memory Unit, then turn the power back ON.</li> </ul>
Flash memory error	An error occurred during initialization of the NT20 or Memory Unit flash memory, or during write processing.	Turn the NT20 power OFF, then back ON. If the error recurs, the flash memory at the write destination may be faulty. In this case, replace the Unit.

<b>Error</b>	<b>Probable Cause</b>	<b>Remedial Action</b>
Verify error	An error occurred during verification processing at the flash memory of the NT20 or the Memory Unit.	Turn the NT20 power OFF, then back ON. If the error recurs, the flash memory at the write destination may be faulty. In this case, replace the Unit.
Transmitting data error (The automatic transmission only)	An attempt is made to transmit data other than a system program or the system program of a different PT model into the NT20 as the system program. An attempt is made to write a system program into the NT20 as screen data.	Perform either of the following procedures. <ul style="list-style-type: none"><li>• Turn the NT20 power OFF, correct the DIP switch settings of the Memory Unit, and then turn the power back ON.</li><li>• Turn the NT20 power OFF, set the DIP switch settings to the manual transmission, and then check the data inside the Memory Unit.</li></ul>



## 2-6 Connecting to the RS-232C Port at the Host

The method for connecting directly between the RS-232C port of the PT and the RS-232C port of the host is as follows.

The following discussion is focused on the connection method to OMRON PLCs.

### Direct Connection between RS-232C Ports with RS-232C Cable

This is the easiest connection method. Depending on the host to which the connection is to be made, it may be possible to use OMRON cables with connectors.

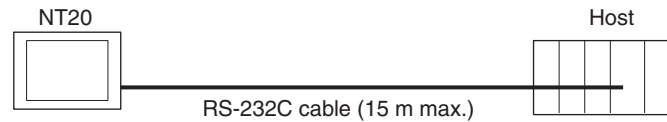

**Note** The CS/CJ-series CPU Unit cannot be connected with the 1:1 NT link method. Use the 1:N NT link method instead of making a 1:1 connection. For details, refer to *Using the 1:N NT Link* on page 60 or *Using the High-speed 1:N NT Links* on page 65.

### 2-6-1 Host Types and Settings

The types of host that can be connected to a PT by using the RS-232C ports of both devices, and the settings to be made at the host, are described here.

#### Using the Host Link Method

##### Compatible Hosts

Some models and series of OMRON PLCs have the Host Link function built in.

In the CS-series (including the CS1-H PLCs), CJ-series, and CQM1H PLCs, the Host Link method can be used by installing a Serial Communications Board or Unit. In addition, some C200HX/HG/HE(-Z)E have an integral CPU Unit that can be connected in the Host Link method by installing a Communications Board.

Check the model and series of the PLC, the type of installed Serial Communications Board, Serial Communications Unit, or Host Link Unit before making a connection.

The hosts that can be connected to the NT20 by the Host Link method using the RS-232C ports of both Units are indicated in the table below.

PLC Series	Units with Built-in Host Link Function	CPU Units Connectable with Host Link Units or Expansion Communications Board	Host Link Unit/ Communications Board	Connectable to
CS Series	CS1G-CPU42/43/44/45-EV1	CS1G-CPU42/43/44/45-EV1	CS1W-SCU21	CS1G
	CS1H-CPU63/64/65/66/67-EV1	CS1H-CPU63/64/65/66/67-EV1	CS1W-SCB21	CS1H
	CS1G-CPU42H/43H/44H/45H	CS1G-CPU42H/43H/44H/45H	CS1W-SCB41	CS1G-H
	CS1H-CPU63H/64H/65H/66H/67H	CS1H-CPU63H/64H/65H/66H/67H		CS1H-H
CJ Series	CJ1G-CPU44/45	CJ1G-CPU44/45	CJ1W-SCU41	CJ1G

PLC Series	Units with Built-in Host Link Function	CPU Units Connectable with Host Link Units or Expansion Communications Board	Host Link Unit/ Communications Board	Connectable to	
C Series	---	C200HS-CPU01/03/21/23/31/33-E C200HE-CPU11/32/42-E C200HE-CPU11/32/42-ZE C200HG-CPU33/43/53/63-E C200HG-CPU33/43/53/63-ZE C200HX-CPU34/44/54/64-E C200HX-CPU34/44/54/64/65/85-ZE	C200H-LK201-EV1	C200HS C200HE C200HE-Z C200HG C200HG-Z C200HX C200HX-Z	
	C200HS-CPU21/23/31/33-E	---	---	C200HS	
	C200HE-CPU42-E C200HE-CPU42-ZE	C200HE-CPU32/42-E C200HE-CPU32/42-ZE	C200HW-COM02/04/05/06-EV1	C200HE C200HE-Z	
	C200HG-CPU43/63-E C200HG-CPU43/63-ZE	C200HG-CPU33/43/53/63-E C200HG-CPU33/43/53/63-ZE		C200HG C200HG-Z	
	C200HX-CPU44/64-E C200HX-CPU44/64/65/85-ZE	C200HX-CPU34/44/54/64-E C200HX-CPU34/44/54/64/65/85-ZE		C200HX C200HX-Z	
	CPM1-10/20/30CDR-□ +CPM1-CIF01	---		---	CPM1
	CPM1A-10/20/30/40CD□-□ +CPM1-CIF01	---	---		
	CPM2A-30/40/60CD□□-□ +CPM1-CIF01 (Peripheral port connection)	---	---	---	CPM2A
	CPM2C-10/20□□□□□□-□ (See note 1.)	---	---	---	CPM2C
	CQM1-CPU21-E CQM1-CPU41/42/43/44-EV1	---	---	---	CQM1
CQM1H-CPU11/21/51/61 (See note 2.)	CQM1H-CPU51/61	CQM1H-SCB41	CQM1H		
CVM1 Series (See note 3.)	CVM1-CPU01-EV2 CVM1-CPU11-EV2 CVM1-CPU21-EV2	CVM1-CPU01-EV2 CVM1-CPU11-EV2 CVM1-CPU21-EV2	CV500-LK201	CVM1	
Compo-Bus/S Master Unit	SRM1-C02-V1	---	---	SRM1	

- Note**
- (1) Use a CPM2C-CN111 or CS1W-CN114/118 Connecting Cable, CPM1-CIF01 RS-232C Adapter, or CPM1-CIF11 RS-422A Adapter to connect.
  - (2) The CQM1H-CPU11 does not have a built-in RS-232C port, so connect to the PT at the peripheral port with a CS1W-CN118 Connecting Cable.
  - (3) CPU Units of CVM1/CV-series PLCs without the suffix -EV□ cannot be connected.

**Settings at the Host**

When using the Host Link method, the settings shown below must be made at the host (depending on the Unit, some of these settings may not be necessary, or settings not shown here may be necessary).

Item	Switch Setting
I/O port	RS-232C
Baud rate	Set the same baud rate as for the NT20. (See note 1.)
Transfer code	ASCII, 7 data bits, 2 stop bits
Parity	Even
1-to-1/1-to-N	1-to-N (See note 2.)
Command level	Level 1, 2, 3
Unit #	00

- Note**
- (1) Set the Host Link baud rate up to 115,200 bps with the memory switch at the NT20.
  - (2) The 1-to-N setting enables BCC (Block Check Character). It is not actually possible to connect more than one NT20 in a single Host Link.

The setting methods for each Unit are described below.

**Connecting to a C-series Host Link Unit**

**C200H, C200HS, and C200HE/HG/HX (-Z)E Rack-mounted Unit:  
C200H-LK201-V1**

**Setting the Front Switches**

Set each switch with a flat blade screwdriver so that the values or symbols in the setting value window agree with the following.

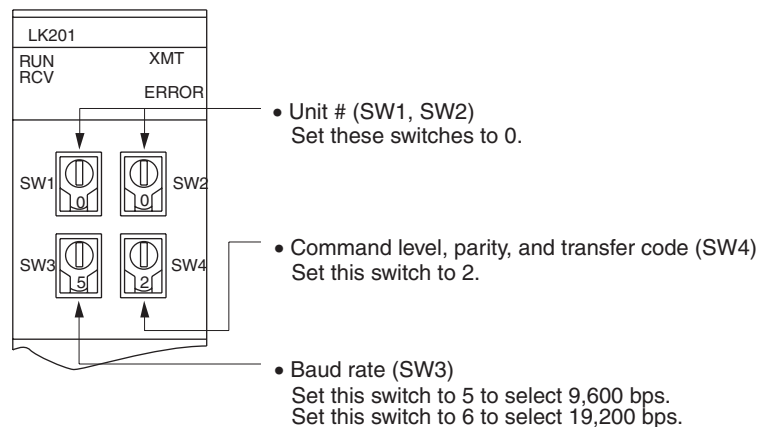

**Setting the Rear Switches**

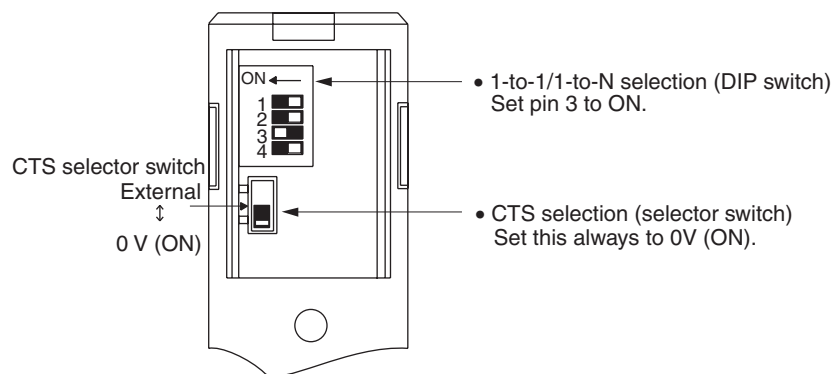

**Connecting to a CVM1/CV-series Host Link Unit**

**CVM1/CV-series Rack-mounted Unit: CV500-LK201**

A CVM1/CV-series Host Link Unit (CV500-LK201) has two connectors (communications ports 1 and 2). Either of these ports can be used for connection to an NT20 by the RS-232C method. However, since the connectors at these ports are of different types, a cable that matches the connector must be prepared.

- Communications Port 1  
Communications port 1 is a 25-pin connector for RS-232C use only.
- Communications Port 2  
Communications port 2 is a 9-pin connector that allows selection of the RS-232C or RS-422A method. When this port is used with the RS-232C method, the I/O port selector switch on the front of the Unit must be set to RS-232C (the upper position).

**CPU Bus Unit Settings**

When connecting to a CVM1/CV-series Host Link Unit, set the following communications conditions for the CPU Bus Unit settings.

Item	Setting at Host
Baud rate	Set the same baud rate as set at the NT20 (See note 1.)
Transfer code	ASCII, 7 data bits, 2 stop bits
Parity	Even
1-to-1, 1-to-N	1-to-N (See note 2.)
Command level	Level 1, 2, 3

- Note**
- (1) Set the Host Link baud rate at 9,600 bps or 19,200 bps with the memory switch at the NT20.
  - (2) The 1-to-N setting enables BCC (Block Check Character). It is not actually possible to connect more than one NT20 in a single Host Link.

Set the CPU Bus Unit settings directly from a Programming Device (e.g., SYSMAC Support Software).

For details on the CPU Bus Unit settings, refer to the *SYSMAC CVM1/CV-series Host Link Unit Operation Manual (W205-E1-□)*.

**Setting the Front Switches**

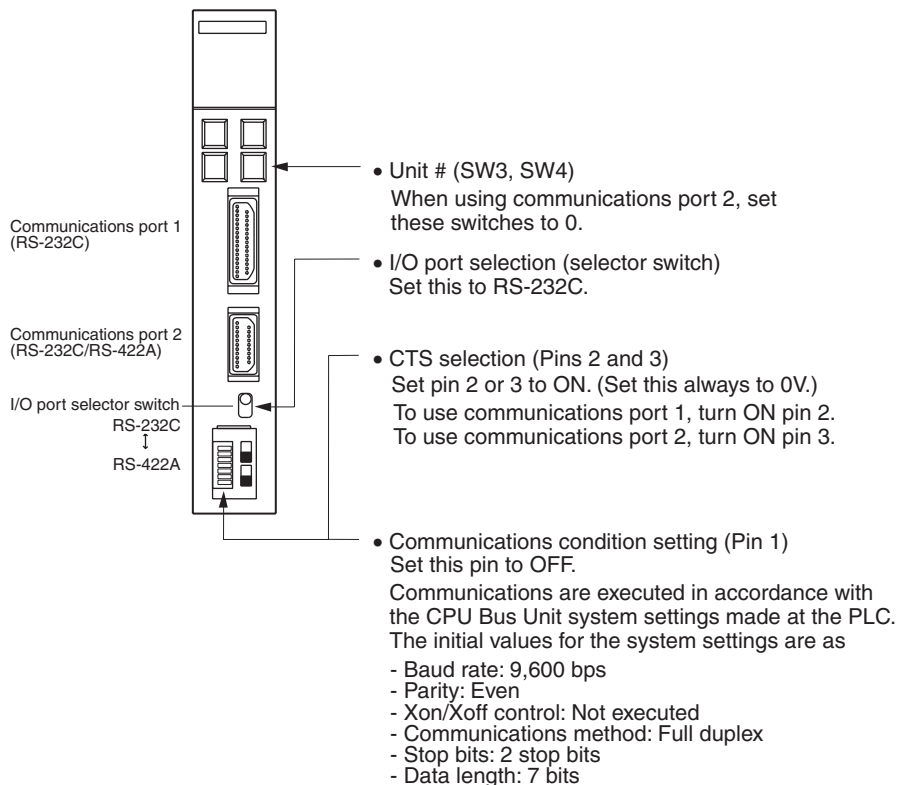

**Connecting to a CS/CJ-series Serial Communications Unit**

**CS/CJ-series Rack-mounted Unit: CS1W-SCU21CJ-series: CJ1W-SCU41 (Port 2 is an RS-232C Port.)**

**Setting the Front Switches**

Set the unit number of the Serial Communications Unit by using the rotary switch located on the front panel. Set each switch with a flat blade screwdriver so that the values or symbols in the setting value window agree with the following.

CS1W-SCU21

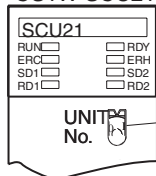

Set the unit number to 0 through F so that it will not duplicate the numbers used in other Units.

CJ1W-SCU41

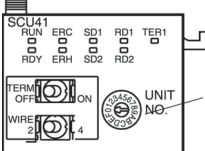

Set the unit number to 0 through F so that it will not duplicate the numbers used in other Units.

**Allocation DM Area Settings for CPU Unit**

Settings are written from the Programming Device (a Programming Console or CX-Programmer) directly into the allocated DM Area (PLC Setup) of the CPU Unit. After the settings are written, they become effective by turning the power ON, restarting the Unit, restarting the communications port, or execution of the STUP instruction.

The following table shows the words allocated in the DM Area and the settings.

$$m = DM30000 + 100 \times \text{unit number}$$

Allocated DM word		Value	Settings
Port 1	Port 2		
m	m+10	8000	Host Link mode, 2 stop bits, even parity, data length 7 bits
m+1	m+11	0000	Baud rate: 9,600 bps.
		0007	Baud rate: 19,200 bps.
		0008	Baud rate: 38,400 bps.
		0009	Baud rate: 57,600 bps.
		000A	Baud rate: 115,200 bps.
m+2	m+12	0000	Transmit delay time 0 ms.
m+3	m+13	0000	No CTS control Unit No.0 for Host Link

**Connecting to a CPU Unit**

**CV-series and CVM1/CV-series (-EV□) CPU Units**

CVM1-CPU01-EV2/CVM1-CPU11-EV2/CVM1-CPU21-EV2

**PLC Setup**

When connecting to a CVM1/CV-series CPU Unit, set the following communications conditions for the PLC Setup.

Item	Setting at Host
Baud rate	Set the same baud rate as set at the NT20 (See note.)
Stop bits	2 stop bits
Parity	Even
Data length	ASCII 7 bits
Unit #	00

**Note** Set the Host Link baud rate at 9,600 bps or 19,200 bps with the memory switch at the NT20.

Either set PLC Setup directly from a Programming Device (e.g., SYSMAC Support Software), or transmit the PLC Setup made at a Programming Device to the CPU Unit.

For details on the PLC Setup, refer to the *SYSMAC CVM1/CV500/1000/2000 Operation Manual: Ladder Diagrams (W202-E1-□)*.

**Setting the Front Switches**

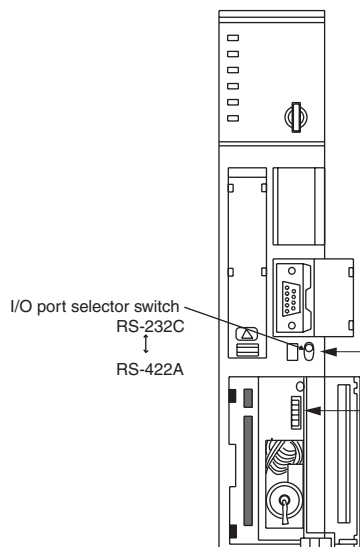

- Host Link Communications method (selector switch)  
Set this to RS-232C.
- System setting (Pin 4)  
To effect the existing DIP switch settings, set SW4 to ON.  
To effect the existing PLC Setup, set pin 4 to OFF.

**Note**

For CPU Units manufactured before or during June 1995 (lot No. jj65), the existing DIP switch settings differ from the existing PLC Setup as follows.

- DIP switch settings:  
2,400 bps, 1 stop bit, even parity, 7 bit data length
- PLC Setup:  
9,600 bps, 2 stop bits, even parity, 7 bit data length

For CPU Units manufactured from July 1995 onward (lot No. □□75), the stipulated values in the DIP switch settings also are 9,600 bps and 2 stop bits.

**C-series C200HS, C200HX/HG/HE(-Z)E, CPM1, CPM2A, CPM2C, CQM1, CQM1H CPU Units and SRM1**

The connection method depends upon the model of PLC being used, as shown in the following table.

PLC model	Connection method
C200HS, CQM1	Connect to the CPU Unit's built-in RS-232C port.
C200HX/HG/HE(-Z)E	<ul style="list-style-type: none"> <li>• Connect to the CPU Unit's built-in RS-232C port.</li> <li>• Connect to one of the RS-232C ports (port A or port B) on a Serial Communications Board.</li> </ul>
CQM1H	<ul style="list-style-type: none"> <li>• Connect to the CPU Unit's built-in RS-232C port.</li> <li>• Connect to the peripheral port through a CS1W-CN118 Connecting Cable.</li> <li>• Connect to the RS-232C port (port 1) on a Serial Communications Board.</li> </ul>
CPM1	Connect to the peripheral port through a CPM1-CIF01 RS-232C Adapter.
CPM2A, SRM1	<ul style="list-style-type: none"> <li>• Connect to the CPU Unit's built-in RS-232C port.</li> <li>• Connect to the peripheral port through a CPM1-CIF01 RS-232C Adapter.</li> </ul>
CPM2C	<p>Connect to the CPU Unit's RS-232C port or the peripheral port through a Connecting Cable (CPM2C-CN111, CS1W-CN118, or CS1W-CN114).</p> <p>(The CPM2C-CN111 splits the Unit's Communications Port into a RS-232C port and a peripheral port. A CPM1-CIF01 RS-232C Adapter is also required to connect to this peripheral port.)</p>

**PLC Setup Settings**

When connecting to a C200HS, C200HX/HG/HE(-Z)E, CPM1, CPM2A, CPM2C, CQM1, or CQM1H CPU Unit, or SRM1, set the following communications conditions for the PLC Setup.

Item	Setting at Host
Communications mode	Host Link mode
Baud rate	Set the same speed as set at the NT20 (See note.)
Stop bits	2 stop bits
Parity	Even
Data length	ASCII 7 bits
Unit #	00

**Note** Set the Host Link baud rate at 9,600 bps or 19,200 bps with the memory switch at the NT20.

Set the PLC Setup settings directly from a Programming Device (e.g., the CX-Programmer Support Software).

For details on operations relating to the PLC Setup, refer to the manual for the PLC which is used.

The PLC Setup area word addresses and settings to be made depending on the Unit and port to which the connection is made are shown below.

CPM2A, CPM2C, CQM1H, or SRM1: Peripheral Port Connection

Word	Writing Value	Settings
DM6650	0001	Host Link mode, no CTS control Communications conditions set by the contents of DM
DM6651	0303	Data length 7 bits, 2 stop bits, even parity, baud rate: 9,600 bps
	0304	Data length 7 bits, 2 stop bits, even parity, baud rate: 19,200 bps
DM6653	0000	Unit # 00

C200HS, C200HX/HG/HE(-Z)E, CPM2A, CPM2C, CQM1, CQM1H (other than the CPU11), or SRM1: Built-in RS-232C Port Connection

Word	Writing Value	Settings
DM6645	0001	Host Link mode, no CTS control Communications conditions set by the contents of DM
DM6646	0303	Data length 7 bits, 2 stop bits, even parity, baud rate: 9,600 bps
	0304	Data length 7 bits, 2 stop bits, even parity, baud rate: 19,200 bps
DM6648	0000	Unit # 00

C200HX/HG/HE(-Z)E: Serial Communications Board Port A

CQM1H: Serial Communications Board Port 1

Word	Writing Value	Settings
DM6555	0001	Host Link mode, no CTS control Communications conditions set by the contents of DM
DM6556	0303	Data length 7 bits, 2 stop bits, even parity, baud rate: 9,600 bps
	0304	Data length 7 bits, 2 stop bits, even parity, baud rate: 19,200 bps
DM6558	0000	Unit # 00



C200HX/HG/HE(-Z)E: Serial Communications Board Port B

Word	Writing Value	Settings
DM6550	0001	Host Link mode, no CTS control Communications conditions set by the contents of DM
DM6551	0303	Data length 7 bits, 2 stop bits, even parity, baud rate: 9,600 bps
	0304	Data length 7 bits, 2 stop bits, even parity, baud rate: 19,200 bps
DM6553	0000	Unit # 00

CPM1: Peripheral Port Connection through a CPM1-CIF01 RS-232C Adapter

Word	Writing Value	Settings
DM6650	0001	Host Link mode Communications conditions set by the contents of DM
DM6651	0303	Data length 7 bits, 2 stop bits, even parity, baud rate: 9,600 bps
	0304	Data length 7 bits, 2 stop bits, even parity, baud rate: 19,200 bps
DM6653	0000	Unit # 00

**Connecting to a CPM2C**

The CPM2C PLCs do not have the same kind of port connectors found on CS1-series PLCs. The CPM2C's communications port handles both RS-232C and peripheral port connections, which are divided internally. Therefore, when using the CPM2C, it is necessary to select RS-232C or peripheral port connections, according to the kind of cable and port (on the cable) used, as shown in the following table. Refer to the *CPM2C Operation Manual* for more details.

Port connecting to PT	PLC Setup
RS-232C port (D-Sub 9-pin) of CPM2C-CN111	Built-in RS-232C port settings
Peripheral port of CPM2C-CN111	Peripheral port settings
RS-232C port (D-Sub 9-pin) of CS1W-CN118	Built-in RS-232C port settings
Peripheral port of CS1W-CN114	Peripheral port settings

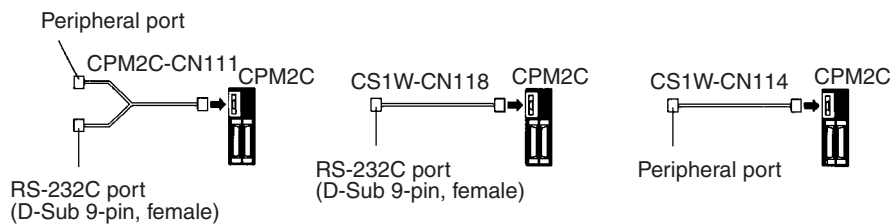

**Setting the DIP Switches of a C200HX/HG/HE(-Z)E, CQM1, or CQM1H**

When using a C200HX/HG/HE(-Z)E, CQM1, or CQM1H, the DIP switches on the front panel must be set as shown below in order to make the settings in the PLC Setup (in the DM Area) effective.

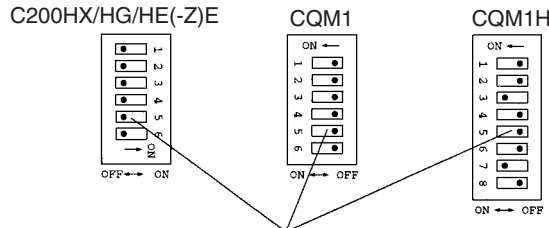

RS-232C port communications condition setting  
Set pin 5 to OFF to make the settings made in PLC Setup effective.

When using the CQM1H's built-in peripheral port, turn ON SW7.

**Setting the Switches of a CPM2A**

When using a CPM2A, the switches on the front panel must be set as shown below in order to make the PLC Setup settings effective.

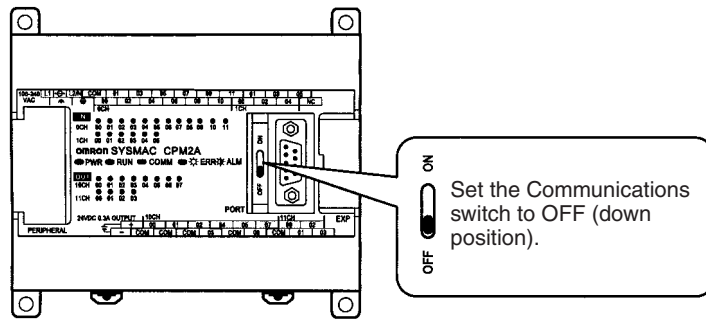

**Setting the Switches of a CPM2C**

When using a CPM2C, the switches on the front panel must be set as shown below in order to make the PLC Setup settings effective.

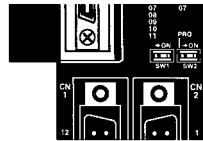

The settings for SW1 and SW2 depend upon the usage of the peripheral port and RS-232C port.

- Connecting PT to peripheral port
- Connecting PT to built-in RS-232C port  
(A device that requires non-standard communications settings is connected to the peripheral port.)

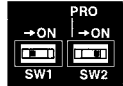

SW1: OFF  
SW2: ON

- Connecting PT to built-in RS-232C port  
(A Programming Console is connected to the peripheral port.)

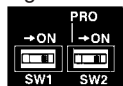

SW1: OFF  
SW2: OFF

**Setting the Switches on an RS-232C Adapter**

When using a CPM1-CIF01 RS-232C Adapter, set the mode switch as shown in the following diagram.



**CS/CJ-series CPU Units:**      **CS1G/H-CPU□□-E (-V1)**  
    **CS1G/H-CPU□□H**  
    **CJ1G-CPU□□**

Connect to the built-in RS-232C port of the CPU Unit, or the RS-232C port of the Communications Board. Note that the connection to a peripheral port must be made via an RS-232C Adapter (CS1W-CN118) specially designed for connecting to a peripheral port.

**PLC Setup**

When connecting to a CS/CJ-series CPU Unit, set the following communications conditions for the PLC Setup. Since the settings shown below are the PLC default settings for the CPU Unit, no change to the PLC Setup is necessary as long as the baud rate is maintained at 9,600 bps.

Item	Setting at Host
Baud rate	Set the same speed as set at the NT20 (See note.)
Stop bits	2 stop bits
Parity	Even
Data length	ASCII 7 bits
Unit No. for the Host Link	00

**Note** Set the Host Link baud rate up to 115,200 bps with the memory switch at the NT20. When the baud rate is set to 19,200 bps, the PLC Setup of the CPU Unit need to be changed.

Either set the PLC Setup directly from a Programming Device (Programming Console), or transmit the PLC Setup made at a Programming Device (CX-Programmer) to the CPU Unit.

For details on PLC Setup, refer to the *SYSMAC CS Series Operation Manual* (W339-E1-□) or *SYSMAC CJ Series Operation Manual* (W393-E1-□).

When using the built-in RS-232C port of a CS1G/H, CS1G/H-H, or CJ1G

Word address	Writing Value	Settings
CIO 160	8000	Host Link mode, data length 7 bits, 2 stop bits, even parity
CIO 161	0000	Baud rate: 9,600 bps.
	0007	Baud rate: 19,200 bps.
	0008	Baud rate: 38,400 bps.
	0009	Baud rate: 57,600 bps.
	000A	Baud rate: 115,200 bps.
CIO 166	0000	Unit #00

When using the peripheral port of a CS1G/H, CS1G/H-H, or CJ1G

Word address	Writing Value	Settings
CIO 144	8000	Host Link mode, data length 7 bits, 2 stop bits, even parity
CIO 145	0000	Baud rate: 9,600 bps.
	0007	Baud rate: 19,200 bps.
	0008	Baud rate 38,400 bps.
	0009	Baud rate 57,600 bps.
	000A	Baud rate 115,200 bps.
CIO 150	0000	Unit #00

**Setting the Front Switches**

Set pins 4 and 5 of the CPU Unit DIP switch according to the port that the NT20 is connected to.

CS1G/H, CS1G/H-H

Peripheral port

This is used mainly for connection to the Programming Device. (This also supports the RS-232C Unit connection.)

RS-232C port

This is used mainly for connection to the RS-232C Unit. (This also supports a CX-Programmer connection.)

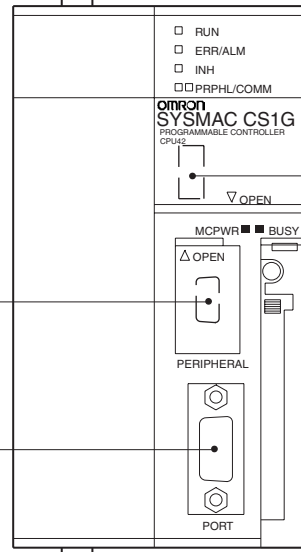

DIP switches (inside the battery storage)

- Set pin 4 to ON (establishing communications in accordance with PLC Setup) when connecting the NT20 to the peripheral port.
- Set pin 5 to OFF (establishing communications in accordance with PLC Setup) when connecting the NT20 to the RS-232C port.

CJ1G

Peripheral port

This is used mainly for connection to the Programming Device. (This also supports the RS-232C Unit connection.)

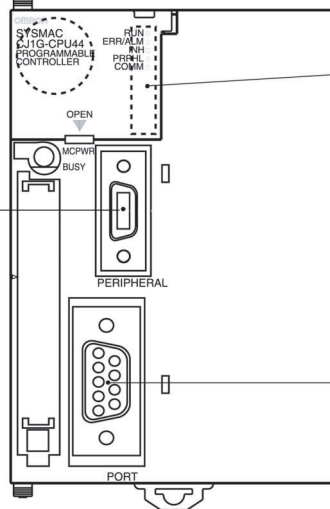

DIP switches (inside the battery storage)

- Set pin 4 to ON (establishing communications in accordance with PLC Setup) when connecting the NT20 to the peripheral port.
- Set pin 5 to OFF (establishing communications in accordance with PLC Setup) when connecting the NT20 to the RS-232C port.

RS-232 port

This is used mainly for connection to the RS-232C Unit. (This also supports a CX-Programmer connection.)

**Connecting to CS-series Serial Communications Board**

Serial Communications Board equipped with a RS-232C port for CS-series CPU Units: CS1W-SCB41/21

**Allocation DM Area Settings for CPU Unit**

Settings are written from the Programming Device (a Programming Console or CX-Programmer) directly into the allocated DM Area (PLC Setup) of the CPU Unit. After the settings are written, they become effective by turning the power ON, restarting the Unit, restarting the communications port, or execution of the STUP instruction.

The following table shows the words allocated in the DM Area and the settings.

Allocated DM word		Value	Settings
Port 1	Port 2		
DM32000	DM32010	8000	Host Link mode, 2 stop bits, even parity, data length 7 bits
DM32001	DM32011	0000	Baud rate 9,600 bps.
		0007	Baud rate 19,200 bps.
		0008	Baud rate 38,400 bps.
		0009	Baud rate 57,600 bps.
		000A	Baud rate 115,200 bps.
DM32002	DM32012	0000	Transmit delay time 0 ms.
DM32003	DM32013	0000	No CTS control Unit No.0 for Host Link

### Using the 1:1 NT Link

#### Compatible Host Units

Some models and series of OMRON PLCs have the 1:1 NT Link function built in. With CQM1H PLCs, a Serial Communications Board can be added to provide 1:1 NT Link communications. Some C200HX/HG/HE(-Z)E CPU Units can be connected by the 1:1 NT Link by installing a Communications Board.

Check the model and series of the PLC against the model of CPU Unit before making the connections.

The hosts that can be connected to the NT20 by the 1:1 NT Link using the RS-232C ports of both Units are indicated in the table below.

PLC Series	CPU Units with Built-in NT Link Function	CPU Units Connectable with Expansion Communications Board (See note 1.)	Connectable to
C Series	C200HS-CPU21-E, -EC C200HS-CPU23-E C200HS-CPU31-E C200HS-CPU33-E	---	C200HS
	C200HE-CPU42-(Z)E	C200HE-CPU32-(Z)E C200HE-CPU42-(Z)E	C200HE (-Z)E
	C200HG-CPU43-(Z)E C200HG-CPU63-(Z)E	C200HG-CPU33-(Z)E C200HG-CPU43-(Z)E C200HG-CPU53-(Z)E C200HG-CPU63-(Z)E	C200HG (-Z)E
	C200HX-CPU44-(Z)E C200HX-CPU64-(Z)E C200HX-CPU65-ZE C200HX-CPU85-ZE	C200HX-CPU34-(Z)E C200HX-CPU44-(Z)E C200HX-CPU54-(Z)E C200HX-CPU64-(Z)E C200HX-CPU65-ZE C200HX-CPU85-ZE	C200HX (-Z)E
	CPM1-10CDR-□ (See note 2.) CPM1-20CDR-□ (See note 2.) CPM1-30CDR-□ (See note 2.) CPM1A-10CD□-□ (See note 2.) CPM1A-20CD□-□ (See note 2.) CPM1A-30CD□-□ (See note 2.) CPM1A-40CD□-□ (See note 2.)	---	CPM1
	CPM2A-30CD□□-□ CPM2A-40CD□□-□ CPM2A-60CD□□-□	---	CPM2A
	CPM2C-10□□□□□□-□ (See note 3.) CPM2C-20□□□□□□-□ (See note 3.)	---	CPM2C
	CQM1-CPU41-EV1 CQM1-CPU42-EV1 CQM1-CPU43-EV1 CQM1-CPU44-EV1 CQM1-CPU45-EV1	---	CQM1
	CQM1H-CPU21-E CQM1H-CPU51-E CQM1H-CPU61-E	CQM1H-CPU51 (See note 4.) CQM1H-CPU61 (See note 4.)	CQM1H
	CVM1 Series (See note 5.)	CVM1-CPU01-EV2 CVM1-CPU11-EV2 CVM1-CPU21-EV2	---
CompoBus/S Master Unit	SRM1-C02-V2	---	SRM1

- Note**
- (1) One of the following Communications Boards is required: C200HW-COM02/COM04/COM05/COM06-EV1.
  - (2) A CPM1-CIF01 adapter is required.
  - (3) Use a CPM2C-CN111 or CS1W-CN114/118 Connecting Cable, CPM1-CIF01 RS-232C Adapter, or CPM1-CIF11 RS-422A Adapter to connect.
  - (4) A CQM1H-SCB41 Serial Communications Board is required.
  - (5) CPU Units of CVM1/CV-series PLCs without the suffix -EV□ cannot be connected.

**Note** CS/CJ-series CPU Unit cannot be connected with the 1:1 connection NT link method. Use the 1:N connection NT link method (standard or high-speed) instead of making the 1:1 connection. For details, refer to *Using the 1:N NT Link* (page 60) or *Using the High-speed 1:N NT Links* (page 65).

**Settings at the Host**

The setting methods for each Unit are as follows:

Connecting to a C-series C200HS, C200HX/HG/HE(-Z)E, CPM1, CPM2A, CPM2C, CQM1, CQM1H, or SRM1

**PLC Setup Settings**

Write the PLC Setup (in the DM Area) settings directly from a Programming Device (e.g., SYSMAC Support Software) according to the host model and port.

Host Model	Word	Writing Value	Setting
RS-232C port of C200HS, C200HX/HG/HE(-Z)E, CPM2A, CPM2C, CQM1, CQM1H, SRM1	DM6645	4000	Use 1:1 NT Link
Port A of C200HX/HG/HE(-Z)E (See note 1.)	DM6555		
Port 1 of CQM1H (See note 2.)			
Port B of C200HX/HG/HE(-Z)E (See note 1.)	DM6550		
CPM1	DM6650		

- Note**
- (1) RS-232C port of the Communications Board
  - (2) RS-232C port of the Serial Communications Board

For details on operations relating to the PLC Setup, refer to the manual for the PLC that is used.

**Connecting to a CPM2C**

The CPM2C PLCs do not have the same kind of port connectors found on CS/CJ-series PLCs. The CPM2C's communications port handles both RS-232C and peripheral port connections, which are divided internally. Therefore, when using the CPM2C, it is necessary to select RS-232C or peripheral port connections, according to the kind of cable and port (on the cable) used, as shown in the following table. Refer to the *CPM2C Operation Manual* for more details.

Port connecting to PT	PLC Setup
RS-232C port (D-Sub 9-pin) of CPM2C-CN111	Built-in RS-232C port settings
Peripheral port of CPM2C-CN111	Peripheral port settings
RS-232C port (D-Sub 9-pin) of CS1W-CN118	Built-in RS-232C port settings
Peripheral port of CS1W-CN114	Peripheral port settings

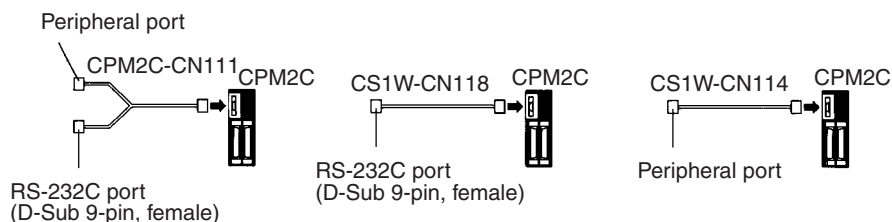

**Setting the DIP Switches on the Front of a C200HX/HG/HE(-Z)E, CQM1, CQM1H**

When using a C200HX/HG/HE(-Z)E, CQM1, or CQM1H, the DIP switches on the front panel must be set as shown below in order to make the settings in the PLC Setup (data memory) effective.

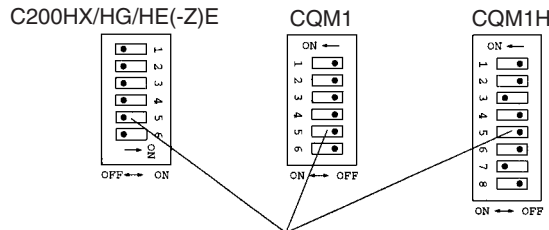

RS-232C port communications condition setting  
Set pin 5 to OFF to make the settings made in PLC Setup effective.

**Setting the Switches of a CPM2A**

When using a CPM2A, the switches on the front panel must be set as shown below in order to make the PLC Setup settings effective.

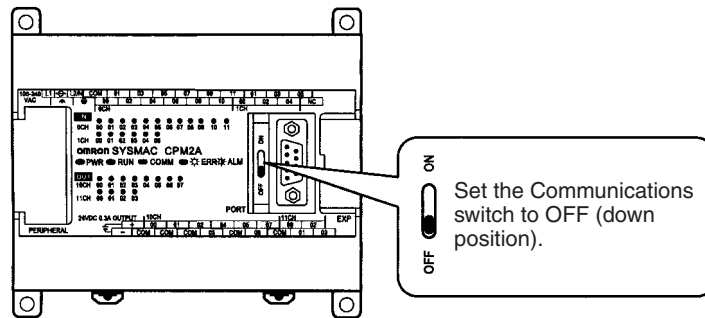

**Setting the Switches of a CPM2C**

When using a CPM2C, the switches on the front panel must be set as shown below in order to make the PLC Setup settings effective.

The settings for SW1 and SW2 depend upon the usage of the peripheral port and RS-232C port.

- Connecting PT to peripheral port
- Connecting PT to built-in RS-232C port  
(A device that requires non-standard communications settings is connected to the peripheral port.)

SW1: OFF  
SW2: ON

- Connecting PT to built-in RS-232C port  
(A Programming Console is connected to the peripheral port.)

SW1: OFF  
SW2: OFF

**Setting the Switches on an RS-232C Adapter**

When using a CPM1-CIF01 RS-232C Adapter, set the mode switch as shown in the following diagram.

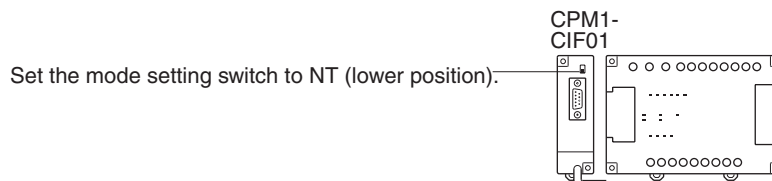



**Connecting to a CVM1/CV (-EV□)**

Set the DIP switch on the front panel as follows:

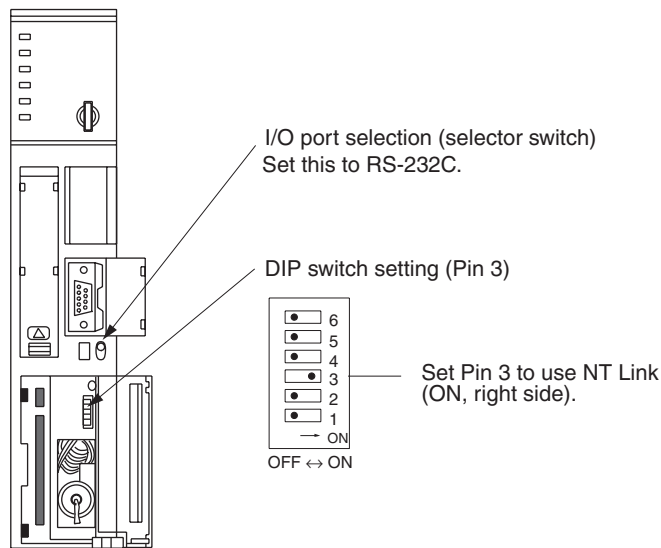

When using a CVM1/CV-series PLC, CPU Unit execution processing (execution control 2) in the PLC Setup must be set to Simultaneous processing.

**Using the 1:N NT Link**

**Compatible Host Units**

The OMRON PLCs that can be connected using the 1:N NT Link are the CS-series (CS1G/H or CS1G/H-H), CJ-series CJ1G, C-series C200HX/HG/HE(-Z)E, CQM1H, and SRM1 only. With the CS/CJ-series PLCs, it is possible to connect a 1:N NT Link using a CS1W-SCU21 or CJ1W-SCU41 Serial Communications Unit.

Check the model and series of the PLC as well as the model of Serial Communications Board or Unit being used before making the connections.

The hosts that can be connected to the NT20 by the 1:N NT Link using the RS-232C ports of both Units are indicated in the table below.

PLC Series	CPU Units with Built-in NT Link Function	CPU Units Connectable with Communications Board or Unit (See note 1.)	Connectable to
CS Series	CS1G-CPU42/43/44/45-EV1 CS1H-CPU63/64/65/66/67-EV1 CS1G-CPU42H/43H/44H/45H CS1H-CPU63H/64H/65H/66H/67H	CS1G-CPU42/43/44/45-EV1 CS1H-CPU63/64/65/66/67-EV1 CS1G-CPU42H/43H/44H/45H (See note 1.) CS1H-CPU63H/64H/65H/66H/67H (See note 1.)	CS1G CS1H CS1G-H CS1H-H
CJ Series	CJ1G-CPU44/45	CJ1G-CPU44/45 (See note 2.)	CJ1G

PLC Series	CPU Units with Built-in NT Link Function	CPU Units Connectable with Communications Board or Unit (See note 1.)	Connectable to
C Series	C200HE-CPU42-(Z)E	C200HE-CPU32-(Z)E (See note 3.) C200HE-CPU42-(Z)E (See note 3.)	C200HE (-Z)E
	C200HG-CPU43-(Z)E C200HG-CPU63-(Z)E	C200HG-CPU33-(Z)E (See note 3.) C200HG-CPU43-(Z)E (See note 3.) C200HG-CPU53-(Z)E (See note 3.) C200HG-CPU63-(Z)E (See note 3.)	C200HG (-Z)E
	C200HX-CPU44-(Z)E C200HX-CPU64-(Z)E C200HX-CPU65-ZE C200HX-CPU85-ZE	C200HX-CPU34-(Z)E (See note 3.) C200HX-CPU44-(Z)E (See note 3.) C200HX-CPU54-(Z)E (See note 3.) C200HX-CPU64-(Z)E (See note 3.) C200HX-CPU65-ZE (See note 3.) C200HX-CPU85-ZE (See note 3.)	C200HX (-Z)E
	---	CQM1H-CPU51 (See note 4.) CQM1H-CPU61 (See note 4.)	CQM1H
CompoBus/S Master Control Unit	SRM1-C02-V2	---	SRM1

- Note**
- (1) A CS1W-SCB21 or CS1W-SCB41 Serial Communications Board or CS1W-SCU21 Serial Communications Unit is required.
  - (2) A CJ1W-SCU41 Serial Communications Unit is required.
  - (3) One of the following Communications Boards is required:  
C200HW-COM02/COM04/COM05/COM06 (-EV1)
  - (4) A CQM1H-SCB41 Serial Communications Board is required.
  - (5) The -V1 versions of CS-series PLCs and CJ-series PLCs support the high-speed 1:N NT Link as well as the standard 1:N NT Link. Furthermore, the high-speed 1:N NT Link can be used in earlier versions of CS-series PLCs by installing a new version of Serial Communications Board or Unit. For details, refer to *Using the High-speed 1:N NT Links* (page 65).

**Settings at the Host**

The Settings required for each Unit are described below.

**Connecting a C200HX/HG/HE(-Z)E, CQM1H, or SRM1**

**PLC Setup Settings**

Write the PLC Setup (in the DM Area) settings directly from a Programming Device (e.g., SYSMAC Support Software) according to the host model and port.

Connection to	Word	Writing Value	Setting
C200HX/HG/HE(-Z)E, SRM1 Built-in RS-232C port	DM6645	5□00	Use 1:N NT Link □ = largest unit number of the connected PTs (1 to 7) (See note 3.)
C200HX/HG/HE(-Z)E Communications Board port A (See note 1.) CQM1H port 1 (See note 2.)	DM6555		
C200HX/HG/HE(-Z)E Communications Board port B (See note 1.)	DM6550		

- Note**
- (1) RS-232C port on the Communications Board
  - (2) RS-232C port on the Serial Communications Board

(3) When using a C200HE (-Z)E, the maximum PT unit number is 3.

Refer to the PLC's operation manual for details on changing PLC Setup settings.

**Setting the DIP Switches of a C200HX/HG/HE(-Z)E**

When using a C200HX/HG/HE(-Z)E, the DIP switches on the front panel must be set as shown below in order to make the settings in the PLC Setup (in the DM Area) effective.

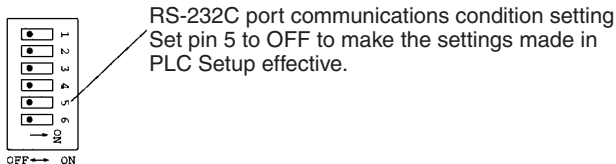

**Connecting to CS/CJ-series CPU Units**

CS-series CPU Unit: CS1G/H-CPU□□-E(V1), CS1G/H-CPU□□H

CJ-series CPU Unit: CJ1G-CPU□□

**PLC Setup**

When connecting to a CS/CJ-series CPU Unit, set the following communications conditions for the PLC Setup, according to the communications port to be used.

When using the built-in RS-232C port of a CS1G/H, CS1G/H-H, or CJ1G

Word	Value	Settings
CIO 160	8200	1:N NT Link mode
CIO 161	0000 to 0009 (See note.)	Communications baud rate (standard)
CIO 166	000□	□ = The largest model number of the connected PT (0 – 7)

**Note** Set any value between 0000 and 0009 Hex for the communications baud rate. The same baud rate will be used regardless of the value as long as it is between 0000 and 0009 Hex.

When using the peripheral port of a CS1G/H, CS1G/H-H, or CJ1G

Word	Value	Settings
CIO 144	8200	1:N NT Link mode
CIO 145	0000 to 0009 (See note.)	Communications baud rate (standard)
CIO 150	000□	□ = The largest model number of the connected PT (0 – 7)

**Note** Set any value between 0000 and 0009 Hex for the communications baud rate. The same baud rate will be used regardless of the value as long as it is between 0000 and 0009 Hex.

When connecting PTs with model numbers 0 and 2 to 5 to the built-in RS-232C port, for example, set CIO 160 to 8200 Hex, CIO 161 to 0000 Hex and set CIO166 to 0005 Hex.

Either set PLC Setup directly from a Programming Device (Programming Console), or transmit the PLC Setup made at a Programming Device (CX-Programmer) to the CPU Unit. For details on PLC Setup, refer to the *SYSMAC CS Series Operation Manual (W339-E1-□)* or *SYSMAC CJ Series Operation Manual (W393-E1-□)*.

**Setting the Front Switches**

Set pins 4 and 5 of the CPU Unit DIP switch according to the port that the NT20 is connected to.

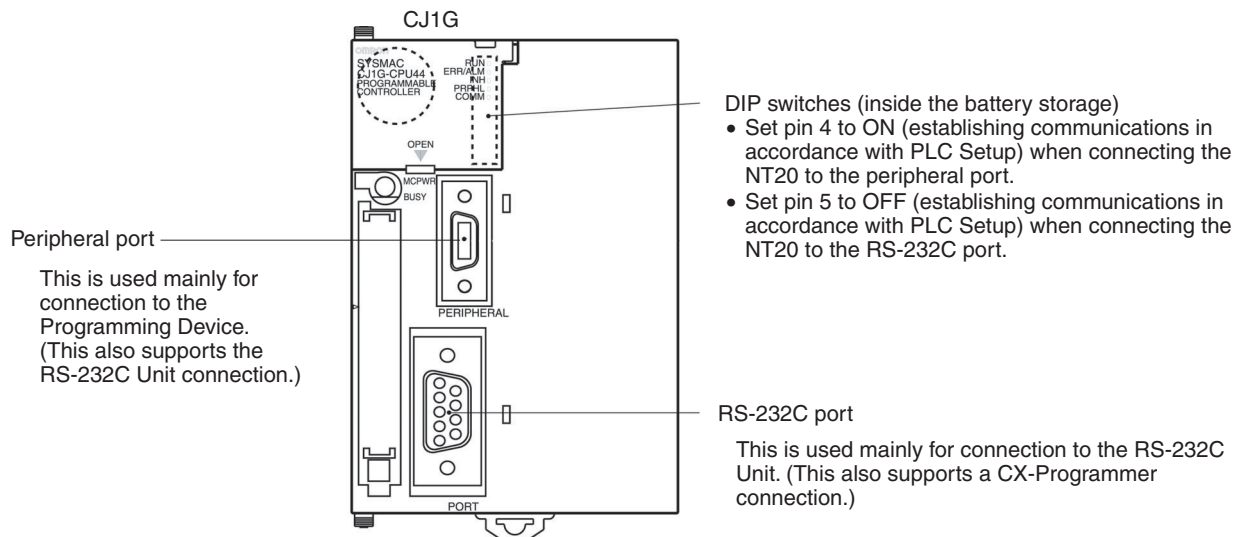
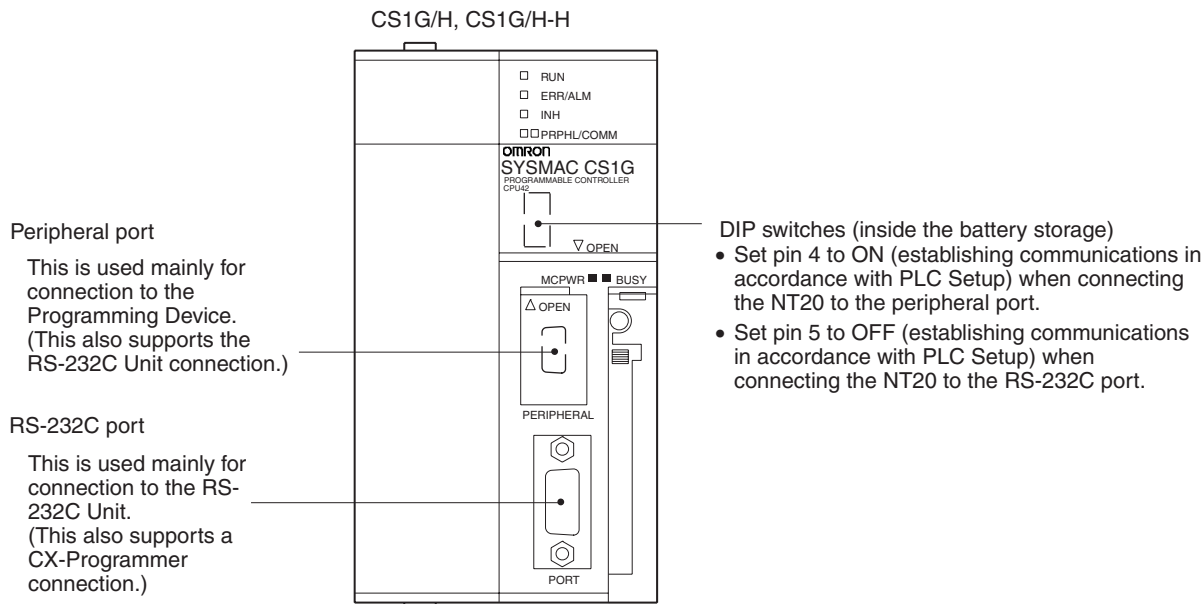

**Connecting to CS-series Serial Communications Board**

Serial Communications Board equipped with a RS-232C port for CS-series CPU Units: CS1W-SCB41/21

**CPU Unit Allocation DM Area Settings**

Setting is written from the Programming Device (a Programming Console or CX-Programmer) directly into the allocated DM Area (PLC Setup) of the CPU Unit. After the setting is written, it becomes effective by turning the power ON, restarting the Unit, restarting the communications port, or execution of the STUP instruction.

The following table shows the words allocated in the DM Area and the settings.

Allocated DM word		Value	Settings
Port 1	Port 2		
DM32000	DM32010	8200	1:N NT Link mode
DM32001	DM32011	0000 to 0009 (See note.)	Communications baud rate (standard)
DM32006	DM32016	000□	□ = The largest model number of the connected PT (0 - 7)

**Note** Set any value between 0000 and 0009 Hex for the communications baud rate. The same baud rate will be used regardless of the value as long as it is between 0000 and 0009 Hex.

For example, when connecting PTs with model numbers 3, 4, 5, and 6 to port 1, set DM 32000 to 8200 Hex, DM 32001 to 0000 Hex, and DM 32006 to 0006 Hex.

**Connecting to CS/CJ-series Serial Communications Unit**

A CS-series Rack-mounted Unit: CS1W-SCU21  
 CJ-series: CJ1W-SCU41 (Port 2 is an RS-232C port.)

**Setting the Front Switches**

Set the unit number of the Serial Communications Unit by using the rotary switch located on the front panel. Set each switch with a flat blade screwdriver so that the values or symbols in the setting value window agree with the following.

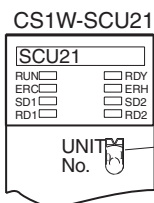

Set the unit number to 0 through F so that it will not duplicate the numbers used in other Units.

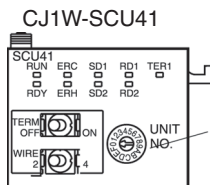

Set the unit number to 0 through F so that it will not duplicate the numbers used in other Units.

**Allocation DM Area Settings for CPU Unit**

Setting is written from the Programming Device (a Programming Console or CX-Programmer) directly into the allocated DM Area (PLC Setup) of the CPU Unit. After the setting is written, it becomes effective by turning the power ON, restarting the Unit, restarting the communications port, or execution of the STUP instruction.

The following table shows the words allocated in the DM Area and the settings.

$$m = DM30000 + (100 \times \text{unit number})$$

Allocated DM word		Value	Settings
Port 1	Port 2		
m	m+10	8200	1:N NT Link mode
m+1	m+11	0000 to 0009 (See note.)	Communications baud rate (standard)
m+6	m+16	000□	□ = The largest model number of the connected PT (0 - 7)

**Note** Set any value between 0000 and 0009 Hex for the communications baud rate. The same baud rate will be used regardless of the value as long as it is between 0000 and 0009 Hex.

**Using the High-speed 1:N NT Links**

**Compatible Host Units**

Only the -V1 versions of the CS1-series CS1G/H, CS1-H-series CS1G/H-H, and CJ-series CJ1G PLCs support the high-speed 1:N NT Links directly. Other CS/CJ-series PLCs can use the high-speed 1:N NT Links indirectly through a CS1W-SCU21 or CJ1W-SCU41 Serial Communications Unit. (If a Serial Communications Unit is used, even CS1-series Units without the “-V1” suffix can be connected via high-speed 1:N NT Links.)

Be sure to check the model number of the PLC and Serial Communications Board/Unit before trying to establish the high-speed 1:N NT Links.

The following table shows which CS1-series PLCs can be connected to an NT20 with the high-speed 1:N NT Links.

PLC model	CPU Units with Built-in NT Link Function	CPU Units Connectable only through a Serial Communications Board or Unit	Connectable models
CS Series	CS1G-CPU42/43/44/45-EV1 (See note 1.) CS1H-CPU63/64/65/66/67-EV1 (See note 1.)  CS1G-CPU42H/43H/44H/45H (See note 1.) CS1H-CPU63H/64H/65H/66H/67H (See note 1.)	CS1G-CPU42/43/44/45-E(V1) (See note 2.) CS1H-CPU63/64/65/66/67-E(V1) (See note 2.) CS1G-CPU42H/43H/44H/45H (See note 2.) CS1H-CPU63H/64H/65H/66H/67H (See note 2.)	CS1G CS1H CS1G-H CS1H-H
CJ Series	CJ1G-CPU44/45	CJ1G-CPU44/45 (See note 3.)	CJ1G

- Note**
- (1) The direct high-speed 1:N NT Link connection is not supported by CS1-series CPU Units without the -V1 suffix.
  - (2) A CS1W-SCB21 or CS1W-SCB41 Serial Communications Board or CS1W-SCU21 Serial Communications Unit is required.
  - (3) A CJ1W-SCU41 Serial Communications Unit is required.

**Settings at the Host**

The Settings required for each Unit are described below.

**Connecting CS/CJ-series CPU Units**

CS-series CPU Unit model: CS1G/H-CPU□□-EV1, CS1G/H-CPU□□H

CJ-series CPU Unit model: CJ1G-CPU□□

**PLC Setup**

When connecting to a CS/CJ-series CPU Unit, set the following communications conditions for the PLC Setup, according to the communications port to be used.

When using the built-in RS-232C port of a CS1G/H, CS1G/H-H, or CJ1G

Word	Value	Settings
160	8200	1:N NT Link mode
161	000A	Communications baud rate (high-speed)
166	000□	□ = The largest model number of the connected PT (0 - 7)

When using the peripheral port of a CS1G/H, CS1G/H-H, or CJ1G

Word	Value	Settings
144	8200	1:N NT Link mode
145	000A	Communications baud rate (high-speed)
150	000□	□ = The largest model number of the connected PT (0 - 7)

When connecting PTs with model numbers 0, 2, 3, 4, and 5 to the built-in RS-232C port, for example, set CIO 160 to 8200 Hex, CIO 161 to 000A Hex, and CIO166 to 0005 Hex.

Either set PLC Setup directly from a Programming Device (Programming Console), or transmit the PLC Setup made at a Programming Device (CX-Programmer) to the CPU Unit.

For details on PLC Setup, refer to the *SYSMAC CS Series Operation Manual* (W339-E1-□) or *SYSMAC CJ Series Operation Manual* (W393-E1-□).

**Note** When using the CX-Programmer to set the high-speed 1:N NT Link, set the communications baud rate to 115,200 bps.

**Setting the Front Switches**

Set pins 4 and 5 of the CPU Unit DIP switch according to the port that the NT20 is connected to.

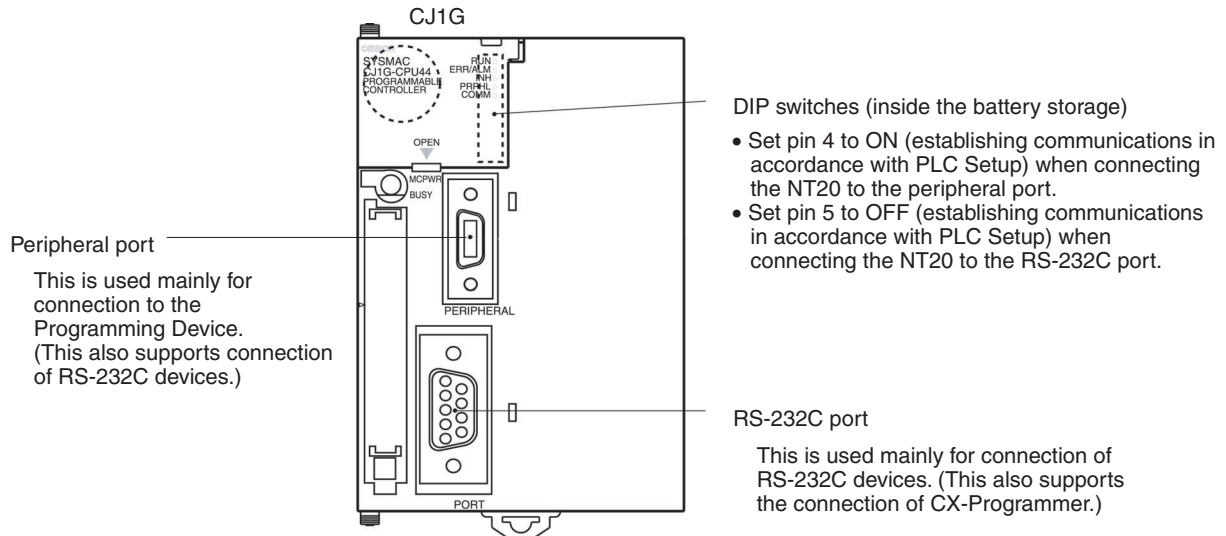
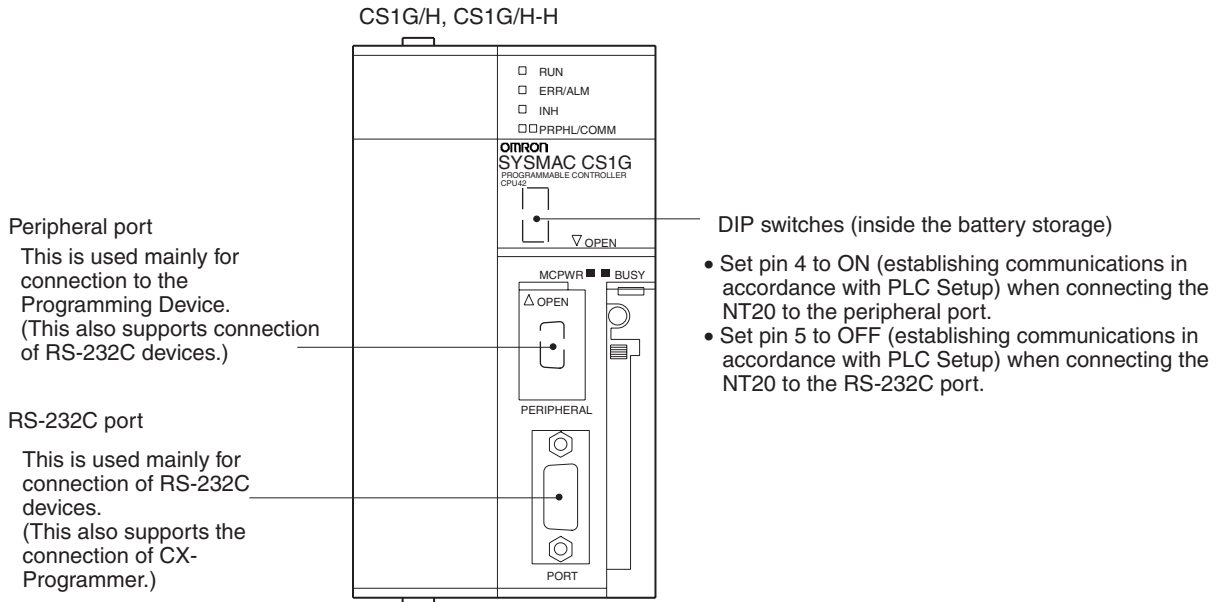

**Connecting to a CS-series Serial Communications Board**

Serial Communications Board equipped with a RS-232C port for CS-series CPU Units: CS1W-SCB41/21

**Note** Serial Communications Boards and Serial Communications Units with lot number 991220 (12/20/99) and later support the high-speed 1:N NT Link. Boards and Units with earlier lot numbers **cannot** be used.

**CPU Unit Allocation DM Area Settings**

Setting is written from the Programming Device (a Programming Console or CX-Programmer) directly into the allocated DM Area (PLC Setup) of the CPU Unit. After the setting is written, it becomes effective by turning the power ON, restarting the Unit, restarting the communications port, or execution of the STUP instruction.



The following table shows the words allocated in the DM Area and the settings.

Allocated DM word		Value	Settings
Port 1	Port 2		
DM32000	DM32010	8200	1:N NT Link mode
DM32001	DM32011	000A	Communications baud rate (high-speed)
DM32006	DM32016	000□	□ = The largest model number of the connected PT (0 - 7)

For example, when connecting PTs with model numbers 3, 4, 5, and 6 to port 1, set DM 32000 to 8200 Hex, DM 32001 to 000A Hex, and DM 32006 to 0006 Hex.

**Connecting to a CS/CJ-series Serial Communications Unit**

A CS-series Rack-mounted Unit: CS1W-SCU21

CJ-series: CJ1W-SCU41 (Port 2 is an RS-232C port.)

**Note** Serial Communications Boards and Serial Communications Units with lot number 991220 (12/20/99) and later support the high-speed 1:N NT Link. Boards and Units with earlier lot numbers **cannot** be used.

**Setting the Front Switches**

Set the unit number of the Serial Communications Unit by using the rotary switch located on the front panel. Set each switch with a flat blade screwdriver so that the values or symbols in the setting value window agree with the following.

CS1W-SCU21

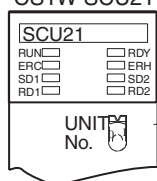

Set the unit number to 0 through F so that it will not duplicate the numbers used in other Units.

CJ1W-SCU41

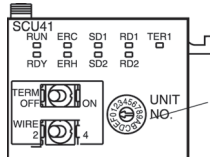

Set the unit number to 0 through F so that it will not duplicate the numbers used in other Units.

**Allocation DM Area Settings for CPU Unit**

Setting is written from the Programming Device (a Programming Console or CX-Programmer) directly into the allocated DM Area (PLC Setup) of the CPU Unit. After the setting is written, it becomes effective by turning the power ON, restarting the Unit, restarting the communications port, or execution of the STUP instruction.

The following table shows the words allocated in the DM Area and the settings.

Word m = DM30000 + 100 × unit number

Allocated DM word		Value	Settings
Port 1	Port 2		
m	m+10	8200	1:N NT Link mode

Allocated DM word		Value	Settings
Port 1	Port 2		
m+1	m+11	000A	Communications baud rate (high-speed)
m+6	m+16	000□	□ = The largest model number of the connected PT (0 - 7)

## 2-6-2 Connecting Directly between RS-232C Ports

The method for connection between the RS-232C ports of the NT20 and the host is described here.

### **Recommended Connector Cable**

When making the connector cable, as far as possible use the recommended connectors, connector hoods, and cables indicated in the table below. Some Units come supplied with one connector and one connector hood.

Check the required components and prepare them in advance.

Name	Model	Remarks	Delivered with
Connector	XM2A-0901	9-pin Made by OMRON	CS-series CS1G/CS1H, CS1G-H/CS1H-H CJ-series CJ1G C-series CQM1, C200HS, C200HX/HG/HE(-Z)E, CVM1/CV-series CPU Units CV500-LK201
	XM24-2501	25-pin Made by OMRON	CV500-LK201 C200H-LK201-EV1
Connector hood	XM2S-0911	9-pin Made by OMRON	C-series CQM1, C200HS, C200HX/HG/HE(-Z)E, CVM1/CV-series CPU Units CV500-LK201
	XM2S-0913	9-pin Made by OMRON	---
	XM2S-0911-E	9-pin Made by OMRON	CS-series CS1G/CS1H, CS1G-H/CS1H-H CJ-series CJ1G
	XM2S-2511	25-pin Made by OMRON	CV500-LK201 C200H-LK201-EV1
Cable	AWG28×5P IFVV-SB	Multi-core shielded cable Made by Fujikura, Ltd.	---
	CO-MA-VV-SB 5P×28AWG	Multi-core shielded cable Made by Hitachi Cable, Ltd.	---

**Note** After connecting a communications cable, always secure it with the screws. Otherwise the cable may disconnect, causing operation to fail.

**OMRON Cables with Connectors**

The OMRON cables listed below can be used when connecting with a method other than the RS-232C communications method.

Model	Cable Length	Connector Specification
XW2Z-200S	2 m	9-pin ↔ 25 pin
XW2Z-500S	5 m	
XW2Z-200T	2 m	9-pin ↔ 9-pin
XW2Z-500T	5 m	

The OMRON cable listed below can be used when connecting to a personal computer using RS-232C communications.

Model	Cable Length	Connector Specification
XW2Z-S002	2 m	9-pin ↔ 9 pin

**Note** The cable's tensile load is 30 N. Do not subject it to loads greater than this. Otherwise a discontinuity may occur, causing operation to fail.

**Wiring for a Host Link Unit (25-pin) Connection**

Applicable Units: C200H-LK201-EV1  
CV500-LK201 (communications port 1)

Compatible cables with attached connectors:  
XW2Z-200S (9-pin ↔ 25-pin, 2 m)  
XW2Z-500S (9-pin ↔ 25-pin, 5 m)

CVM1/CV-series Host Link Units (CV500-LK201) have two types of connector; a 25-pin connector (communications port 1), and a 9-pin connector (communications port 2). When using communications port 2, refer to *Wiring for Other Connections (Other Than the Memory Link Method)* below.

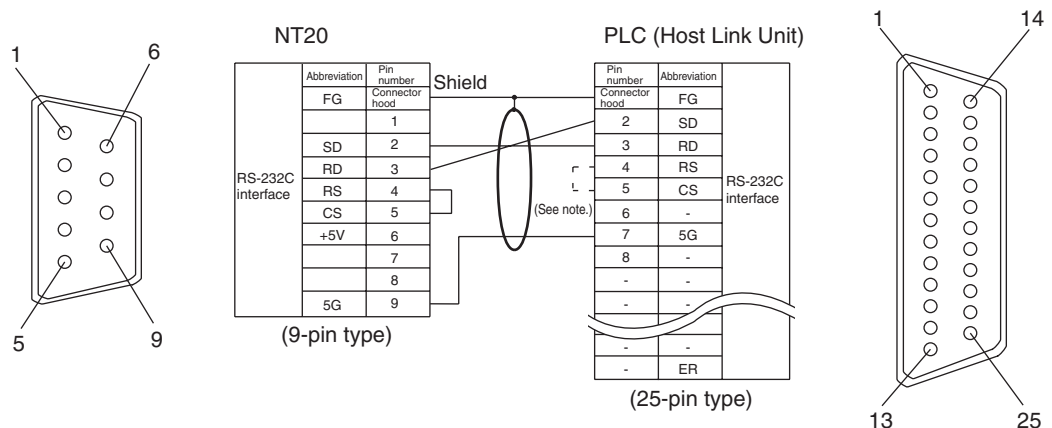

**Note** For Units that have a CTS setting selector switch, RS and CS do not have to be shorted if this switch is set to 0 V.

**Wiring for Other Connections**

Applicable Units:  
CV500-LK201 (communications port 2)  
CS1W-SCU21                      CJ1W-SCU41  
CPM1-10CDR-□                  CPM1-20CDR-□  
CPM1-30CDR-□  
CPM1A-10CD□-□                CPM1A-20CD□-□  
CPM1A-30CD□-□                CPM1A-40CD□-□  
CPM2A-30CD□-□                CPM2A-40CD□-□  
CPM2A-60CD□-□  
CPM2C-10□□□□□□-□        CPM2C-20□□□□□□-□

- CQM1-CPU21-E
- CQM1-CPU41-EV1
- CQM1-CPU43-EV1
- CQM1H-CPU11
- CQM1H-CPU51
- CS1G-CPU42-E(V1)
- CS1G-CPU44-E(V1)
- CS1H-CPU63-E(V1)
- CS1H-CPU65-E(V1)
- CS1H-CPU67-E(V1)
- CS1G-CPU42H
- CS1G-CPU44H
- CS1H-CPU63H
- CS1H-CPU65H
- CS1H-CPU67H
- CJ1G-CPU44
- C200HS-CPU21-E, -EC
- C200HS-CPU31-E
- C200HE-CPU32-(Z)E
- C200HG-CPU33-(Z)E
- C200HG-CPU53-(Z)E
- C200HX-CPU34-(Z)E
- C200HX-CPU54-(Z)E
- C200HX-CPU65-ZE
- CVM1-CPU01-EV2
- CVM1-CPU21-EV2
- SRM1-C02-V2
- CQM1-CPU42-EV1
- CQM1-CPU44-EV1
- CQM1H-CPU21
- CQM1H-CPU61
- CS1G-CPU43-E(V1)
- CS1G-CPU45-E(V1)
- CS1H-CPU64-E(V1)
- CS1H-CPU66-E(V1)
- CS1G-CPU43H
- CS1G-CPU45H
- CS1H-CPU64H
- CS1H-CPU66H
- CJ1G-CPU45
- C200HS-CPU23-E
- C200HS-CPU33-E
- C200HE-CPU42-(Z)E
- C200HG-CPU43-(Z)E
- C200HG-CPU63-(Z)E
- C200HX-CPU44-(Z)E
- C200HX-CPU64-(Z)E
- C200HX-CPU85-ZE
- CVM1-CPU11-EV2

Compatible cables with attached connectors:

- XW2Z-200T (9-pin ⇔ 9-pin, 2 m)
- XW2Z-500T (9-pin ⇔ 9-pin, 5 m)

CPU Units of CVM1/CV-series PLCs without the suffix -EV□ cannot be connected by any connection method.

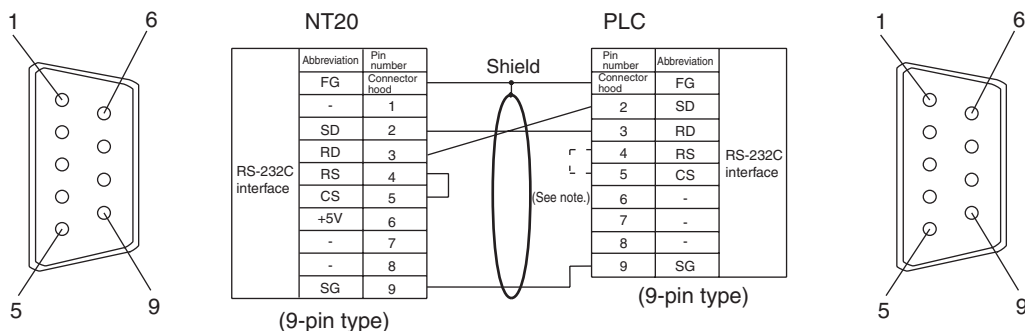

**Note** For Units that have a CTS setting selector switch, RS and CS do not have to be shorted if this switch is set to 0 V.

**Wiring for a RS-232C Connection**

Compatible cables with attached connectors:  
 XW2Z-S002 (9-pin⇔9-pin, 2 m)  
 Prepare the adapter cable while referring to the following diagram.

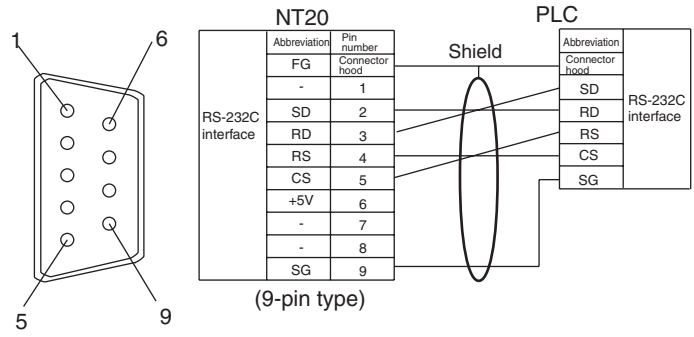

## 2-7 Communicating with the PLC Using C200H Direct Communications

Connect an NT20-ST121-E and PLC made by OMRON with an I/O cable.

### 2-7-1 Applicable PLC Units

Before making the connection, check the series and model of the PLC to which the connection is to be made. A list of the PLCs that can be connected to an NT20 using C200H direct communications is presented below.

CPU Unit	Model Name
C20H/C28HC40H/C60H	C□□H
C200H-CPU01-E	C200H
C200H-CPU03-E	
C200H-CPU11-E	
C200H-CPU21-E	
C200H-CPU23-E	
C200H-CPU31-E	
C200HS-CPU01-E	
C200HS-CPU03-E	
C200HS-CPU21-E	
C200HS-CPU23-E	
C200HS-CPU31-E	
C200HS-CPU33-E	
C200HE-CPU11-E	C200HE
C200HE-CPU32-E	
C200HE-CPU42-E	
C200HG-CPU33-E	C200HG
C200HG-CPU43-E	
C200HG-CPU53-E	
C200HG-CPU63-E	
C200HX-CPU34-E	C200HX
C200HX-CPU44-E	
C200HX-CPU54-E	
C200HX-CPU64-E	

 **Caution** With systems in which the user program operates according to the PLC cycle time, since there is some fluctuation in the PLC cycle time, the system operation may not be consistent, and this should be born in mind when designing the system.

### 2-7-2 Connection Method

The NT20 PT is connected to the PLC using the NT20-IF001 and NT600M-LB122-V1.

The connection conditions are different for C200H/HS, C200HX/HG/HE and C□□H.

**Mounting the NT20-IF001**

1. As shown in the following diagram, connect the NT20 connector on the back of the NT20-IF001 to the expansion interface connector on the NT20 PT.

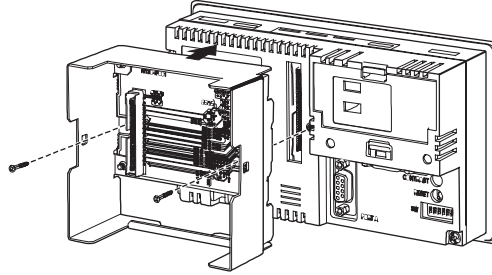

2. After connecting the connector, secure the NT20-IF001 with the two screws. The tightening torque is 0.6 N•m.
3. As shown in the following diagram, hold the Interface Unit with the notch on the left and press the Interface Unit into the NT20-IF001 until it clicks into place.

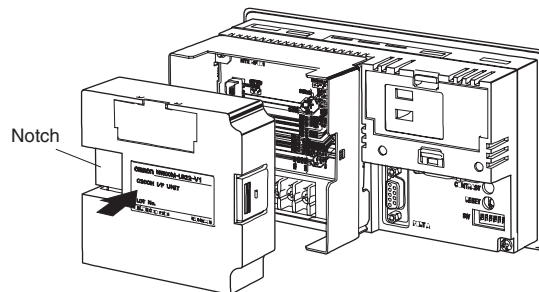

4. Connect the ground screw on the NT20-IF001 to the NT20 using a short wire (100 mm max.), and connect the ground through the NC terminal.

**Reference:**

The NC terminal on the NT20 also serves as a functional ground. Do not connect this terminal when using only the NT20 (grounding is not required).

- ⚠ **Caution** Always turn off the power at the PLC and PT before connecting the C200H interface cable. Otherwise the system may operate unpredictably.
- ⚠ **Caution** Make sure that the power supply to the PT is OFF before connecting or disconnecting the Interface Unit. After mounting an NT20-IF001, be sure to tighten its two screws. Do not touch the PCB (printed circuit board) with bare hands.
- ⚠ **Caution** After connecting the communications cable, always secure it with the screws. Otherwise the cable may disconnect, causing operation to fail.

**I/O Connecting Cable**

Use the following models of I/O Connecting Cable.

	Model	Cable Length (L)
For connecting C200H/HS/HE/HG/HX	C200H-CN311	30 cm
	NT20M-CNP711 C200H-CN711	70 cm
	NT20M-CNP221 C200H-CN221	2 m
	NT20M-CNP521 C200H-CN521	5 m
	NT20M-CNP131 C200H-CN131	10 m
	For connecting C□□H	C20H-CN312
NT20M-CNP712 C20H-CN712		70 cm
NT20M-CNP222 C20H-CN222		2 m

**Note** The C200H interface connector of NT20M-CNP□□□ has been downsized.

**⚠ Caution** Keep the total length of I/O cables used within 12 m (6 m for C□□H).

**⚠ Caution** The cable's tensile load is 30 N. Do not subject it to loads greater than this. Otherwise a discontinuity may occur, causing operation to fail.

**Reference:**

If a C200H-CN□□□ or C20H-CN□□□ is used as the I/O Connecting Cable, the connector will project beyond the bottom face of the NT20.

If the I/O cable is passed through a hole or other opening, the diameter of the hole or opening must be at least 53 mmφ. Removing the top cover reduces this requirement to 33 mmφ or larger. During installation, this cover must be replaced before securing the PT.

**Connection to C200H/  
C200HS and C200HX/HG/  
HE**

Connect the CPU Rack or Expansion I/O Rack with an I/O cable. The following restrictions apply when making this connection.

- A maximum of one CPU Rack and one Expansion I/O Rack can be connected. Connection to two Expansion I/O Racks is not possible.
- Connection to a Remote Rack is not possible.



- There is only one C200H interface unit interface connector. This means that it is not possible to connect an NT20 between a CPU Rack and an Expansion I/O Rack. It must be the final connection in the system.

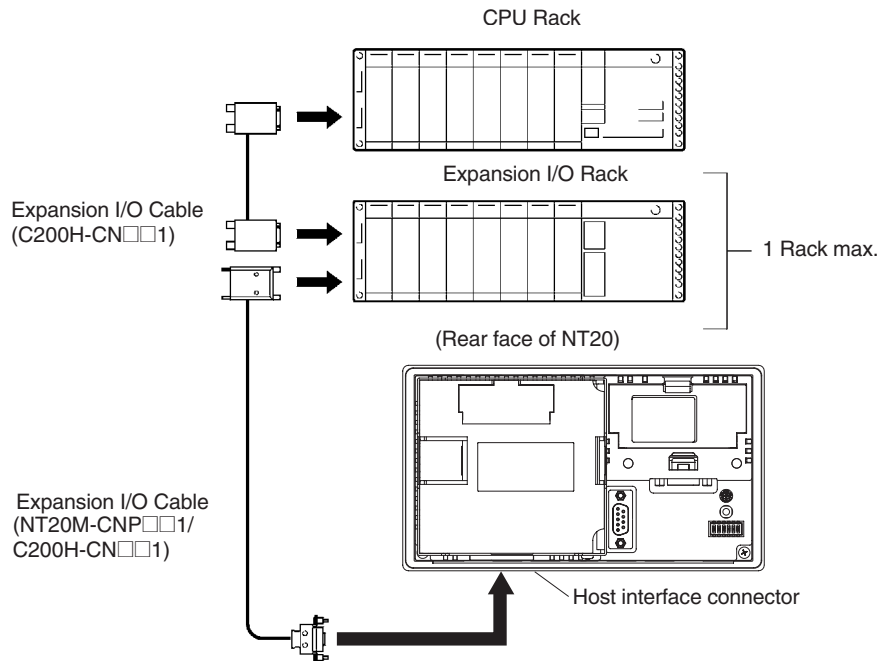

**Connection to C□□H**

Connect the CPU Unit with an I/O Connecting Cable. The following restrictions apply when making this connection.

- A maximum of one CPU Unit can be connected.
- Up to two I/O Units can be connected for the one CPU unit, but Expansion I/O Units cannot be connected.

- It is not possible to connect a C□□H I/O Unit after the NT20. It must be the final connection in the system.

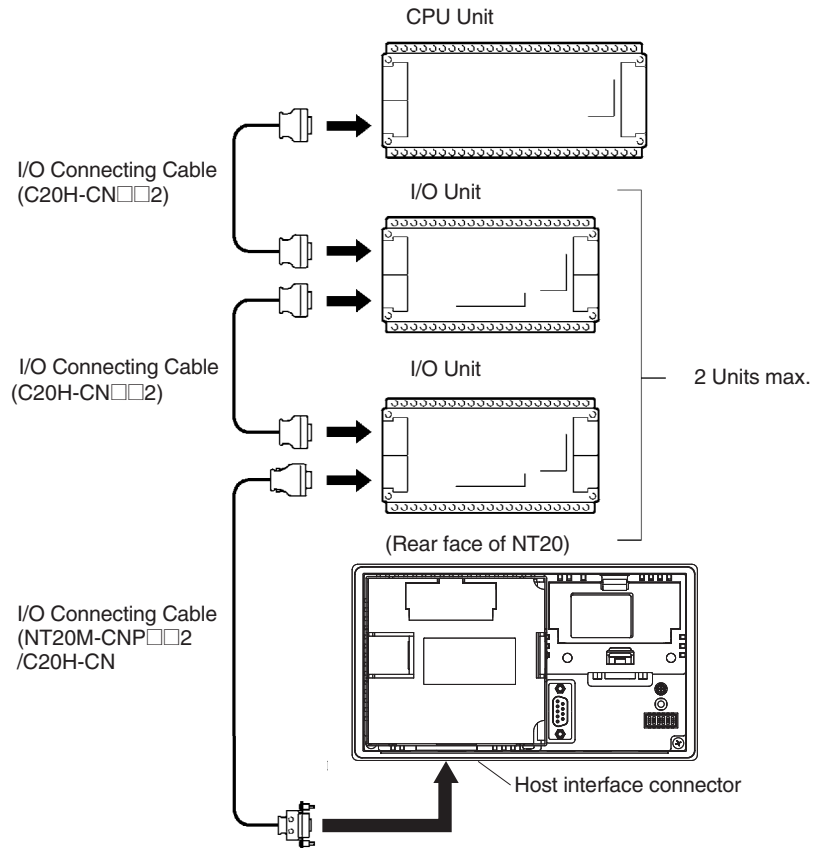

**Note** When connecting a C□□H, always install a noise filter.

1. Insert the noise filter in the power supply line of the C□□H.
2. Make the distance between the noise filter and the C□□H as short as possible and separate it from the power supply line.
3. Install the noise filter case on the FG face.
4. Use a ZGB2202-01U (manufactured by TDK) or equivalent as the noise filter.

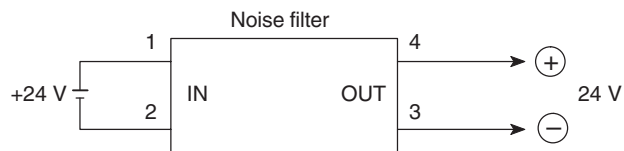

### 2-7-3 Turning the Power ON/OFF When Using C200H Direct Communications

The NT20-ST121-E functions as an expansion I/O unit of the PLC. Use the following procedure to turn the power ON and OFF.

**Caution** Depending on the method used to turn the power ON and OFF, the entire system may stop. Follow the procedure described below to turn the power ON and OFF.

#### Power ON

Turn the power ON as follows:  
 Turn ON the power to the NT20.  
 “Connecting to Host” is displayed on the NT20 screen.

↓

Turn ON the power to the PLC.

After “Connecting to Host” has been displayed for approximately 1 second, normal operation starts.

- Note**
- (1) If the power to the PLC is turned ON first, the CPU Unit of the PLC is subjected to a system reset, making operations such as programming console impossible. Then, when the power to the NT20 is turned ON, “Connecting to Host” is displayed on the NT20 screen for approximately 1 second, after which normal operation starts.
  - (2) If the I/O Connecting Cable is disconnected during system operation, an I/O bus error occurs at the PLC and operation stops. If this happens, connect the I/O Connecting Cable and cancel the error.

#### Power OFF

Turn the power OFF as follows:

Turn OFF the power supplies to the PLC and NT20 simultaneously.

The next time the power is turned ON, the NT20 displays the screen that was displayed when the power was turned OFF.

- Note**
- If the power to the NT20 is turned OFF first, the CPU Unit of the PLC is subjected to a system reset, making operations such as programming console impossible.

Turn OFF the system temporarily before replacing the NT20 (when a fault occurs, for example). If the power to the NT20 only is turned OFF, the system stops immediately and this could cause an accident or damage machinery.

## 2-8 Host Connections by RS-232C (NT20-ST128)

Connect the NT20-ST128 with an RS-232C Interface Unit installed to the host computer with an RS-232C cable.

An RS-232C connection allows a single NT20 to be connected to the host.

A computer or other control device with a built-in RS-232C interface is a suitable host for connection to the NT20.

### 2-8-1 Host Computer Communications Settings

Set the host communications conditions according to the following table.

Item	Setting
Baud rate	Set to the same baud rate as the NT20: 2400, 4800, 9600, 19200
Data bits	7 bits/8 bits
Stop bits	1 bit/2 bits
Parity	Even, Odd, None
Flow control	RS/CS control XON/XOFF control None

**Note** Set the same communications conditions at the NT20 and Host.

Refer to the appropriate instruction manuals for the method of setting the Host communications conditions.

Set to the maximum baud rate supported by both the NT20 and Host.

The communications condition settings of the NT20-ST128 are set with the RS-232C communications conditions memory switches.

### 2-8-2 Connector Pin Arrangement

The RS-232C connection between the NT20 and Host is described below.

#### NT20 Interface Unit

The connector specifications are described below.

Electrical characteristics: Conforms to EIA RS-232C specifications.

Signal direction: Signal input and output are relative to the host computer.

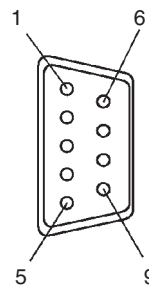

Connector pin #	Signal name	Abbreviation	Signal direction
			NT20 ← → Host
2	Send data	SD (TXD)	→
3	Receive data	RD (RXD)	←
4	Request to send	RS (RTS)	→
5	Clear to send	CS (CTS)	←

Connector pin #	Signal name	Abbreviation	Signal direction
			NT20 ← → Host
6	+5 V output, 150 mA max.	+5 V	→
9	Signal ground	SG (GND)	---

**Note** Unlisted pins are not used.

**Note** For cable parts and the wiring method, refer to *Appendix C Transporting and Storing PTs* on page 263.

**Connecting to the Host Computer**

Use a cable that is compatible with the RS-232C connector of the host to connect the NT20 and the host (see the example in the figure below).

In the example shown here, the cable connects the 9-pin connector of the NT20 and 25-pin connector of the host. If the host has a 9-pin RS-232C connector, use an RS-232C cable with 9-pin connectors at both ends.

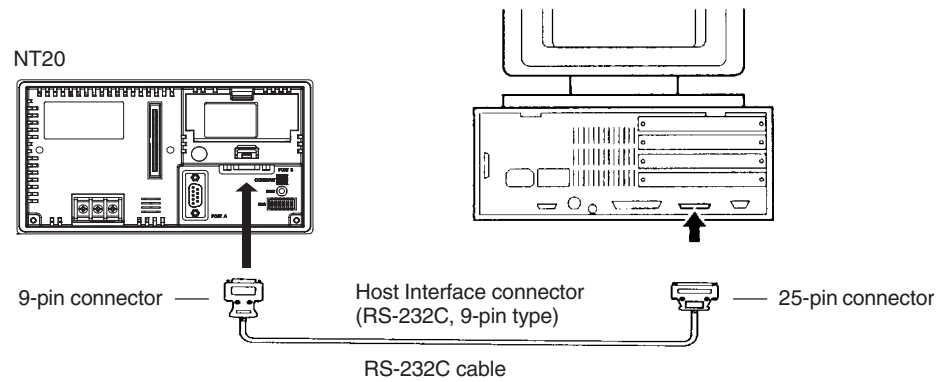

**Caution** When making the connection, turn OFF the power to the NT20 and PLC before disconnecting or connecting any connector.

**Caution** After connecting the communications cable, always secure it with the screws. Otherwise the cable may disconnect, causing operation to fail.

**Note** If using the +5 V supply of pin No.6, check first that the equipment that is to receive the supply has a current capacity no greater than 150 mA. The +5 V output of the NT20 is +5 V DC ±5%, 150 mA max.

Do not use both port's +5 V output at the same time.

# SECTION 3

## System Menu Operation

This section describes the operation of the System Menu focusing on the procedure to start up the NT20. Functions which will be convenient to use the NT20 and those which are useful for the system maintenance are also explained here.

3-1	Operation Flow by the System Menu . . . . .	82
3-2	Starting the NT20 . . . . .	83
3-2-1	Changing the System Settings or Screen Data . . . . .	83
3-3	Operation Modes and the System Menu . . . . .	84
3-3-1	System Menu and the Operation Modes. . . . .	84
3-3-2	Menu Tree. . . . .	84
3-3-3	Operations with the System Menu . . . . .	86
3-4	Initializing Memory . . . . .	88
3-4-1	Initialization by Using the System Menu . . . . .	88
3-4-2	Initialization by Using the DIP Switch (Forced Initialization). . . . .	90
3-5	Setting the Conditions of Communications with the Host by Using the Memory Switches . . . . .	91
3-5-1	Selecting the Host Communications Method . . . . .	93
3-5-2	Selecting the Host Communications Port. . . . .	94
3-5-3	Selecting the Host Link Communications Speed . . . . .	95
3-5-4	Selecting the NT Link (1:N) Communications Speed . . . . .	96
3-5-5	Selecting Unit Numbers . . . . .	97
3-5-6	Selecting the Automatic Reset Function. . . . .	98
3-5-7	Setting RS-232C Communications Conditions (NT20-ST128). . . . .	99
3-6	Registering the Screen Data . . . . .	102
3-7	Starting the Operation . . . . .	105
3-8	Various System Settings . . . . .	106
3-8-1	Setting the Key Press Sound. . . . .	106
3-8-2	Using the Buzzer. . . . .	107
3-8-3	Backlight OFF Function. . . . .	109
3-8-4	Language Function . . . . .	110
3-8-5	Support Tool Mode Setting (NT20-ST121-E) . . . . .	111
3-8-6	Lamp Bit Control (NT20-ST128). . . . .	112
3-9	System Maintenance . . . . .	115
3-9-1	I/O Check . . . . .	115
3-9-2	Checking the PT Setting. . . . .	122
3-9-3	Checking the NT20 DIP Switch Settings . . . . .	124
3-10	Transferring the System Program . . . . .	126
3-11	Transferring the Resource Data. . . . .	129

## 3-1 Operation Flow by the System Menu

Follow the procedure below when using the NT20 for the first time or when changing the system.

### Create the Screen Data

Create the screen data to be displayed on the NT20 by using the Support Tool.

For the screen data creation, refer to the "NT Support Tool for Windows Operation Manual" (V061-E1-□).

### Start Up the NT20 (Display the System Menu.) (page 84)

Turn ON the power to the NT20.

When no screen data has been registered, the "SYSTEM MENU" will be displayed. If the NT20 enters the RUN mode, press appropriate touch switches to display the System Menu.

### Initializing Memory (page 88)

Select a System Menu and initialize the NT20 unit memory.

### Memory Switch Settings (page 91)

Select the System Menu and make settings such as the communications conditions for communications with the Host by setting the memory switches.

### Registering the Screen Data (page 102)

Connect the Support Tool to the NT20 and transfer the screen data from the Support Tool to the NT20.

For the connection of the Support Tool, refer to *2-4 Connecting the NT Support Tool* on page 35.

### Starting the Operation (page 105)

Connect to the PLC/Host and start the operation.

### System Maintenance (page 115)

If an error has occurred during operation, check the I/Os, settings, etc. referring to this guide.

## 3-2 Starting the NT20

When the NT20 is started, it will enter the RUN mode if system settings and screen data registration have been completed. If no screen data has been registered or the screen data are destroyed, the System Menu will be displayed.

Before turning ON the power, check the following DIP switch settings on the NT20.

- SW2-3 “Switch to the System Menu enabled/disabled” is set to OFF (enabled).
- SW2-1 “Screen data forced initialize Yes/No” is set to No (ineffective).

For the DIP switch settings of the unit, refer to the *2-1-2 Operation Status DIP Switch Settings* (page 19).

### 3-2-1 Changing the System Settings or Screen Data

Follow the procedure below to change the system settings or screen data contents.

- Note**
- (1) Turn ON the power to the NT20.  
The NT20 will enter the RUN mode and the start-up screen will be displayed. The start-up screen varies according to registered screen data.
  - (2) Press appropriate touch switches to display the System Menu, and change system settings. For the method for calling the System Menu, refer to the *3-3-3 Operations with the System Menu* on page 86.
  - (3) If the NT20 has failed to start up normally; an error message is displayed or no screen is displayed, memory needs to be initialized.  
For the memory initializing procedure, refer to *3-4 Initializing Memory* on page 88.



### 3-3 Operation Modes and the System Menu

The NT20 operates in either “RUN”, “Transmit”, or “Maintenance” mode. The operation modes can be changed by using the System Menu.

#### 3-3-1 System Menu and the Operation Modes

Select an operation mode by pressing the corresponding touch switch in the System Menu. The operation modes with respect to the System Menu are related to each other as shown below.

For the operations with the System Menu, refer to the *3-3-3 Operations with the System Menu* (page 86).

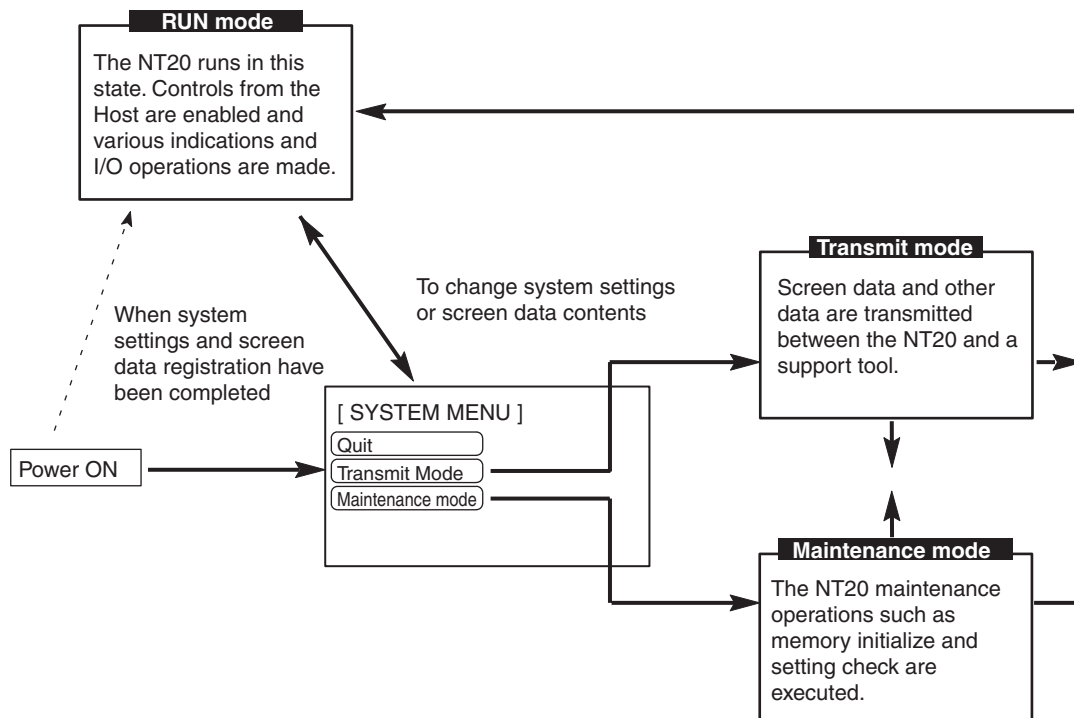

#### 3-3-2 Menu Tree

The System Menu allows to effect various NT20 functions by using the touch switches. The NT20’s functions with respect to the System Menu are related as shown below.

For the operations with the System Menu, refer to the *3-3-3 Operations with the System Menu* (page 86).

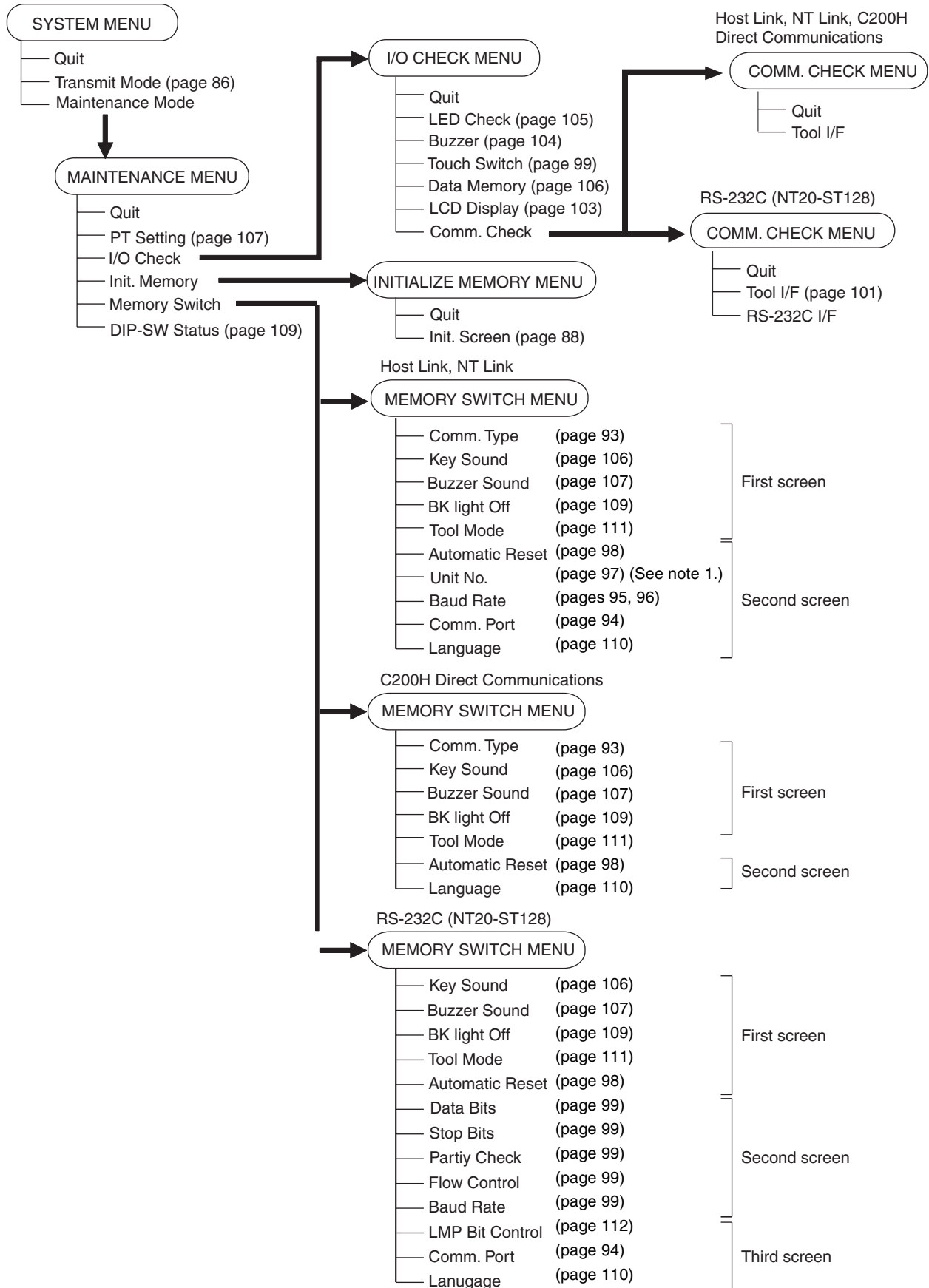

**Note** The unit number must be set only for 1:N NT Link communications.

### 3-3-3 Operations with the System Menu

The following gives the procedure to call the System Menu, select the menu items, and other operations with the System Menu.

Make sure that DIP SW2-3 “Switch to the System Menu enabled/disabled” is set to OFF (enabled). If the setting is ON (disabled), the System Menu will not be displayed by following the procedure given below.

#### Displaying the System Menu

Press appropriate touch switches to display the System Menu as described below. The “RUN” LED goes off when the System Menu is displayed.

The NT20 display screen has four touch switches to display the System Menu in the four corners (about 9 mm x 9 mm size). Press any two of these switches at the same time to call the System Menu screen.

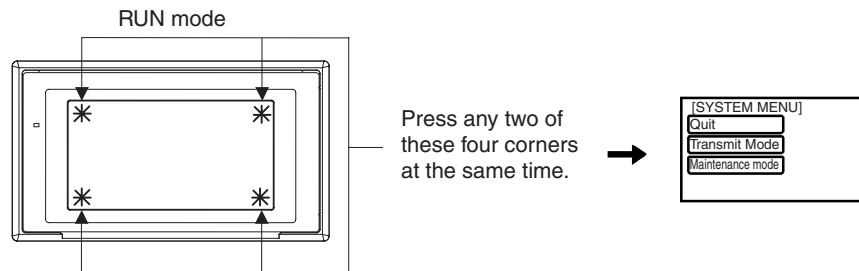

Note that the touch switches used to call the System Menu are not displayed on the screen. If a touch switch displayed in a corner is pressed first, the touch switch will function and the System Menu will not be displayed. To successfully call the System Menu, first press a corner where no touch key is displayed, and then, press any other corner regardless of the presence of a touch key.

If a screen has the touch switches registered at all of the four corners, it is impossible to call the System Menu from the screen.

A “system key” function can be assigned to a touch switch. Pressing the touch switch so assigned on the screen can easily display the System Menu. For the relationship between the system key and the touch switch, refer to the 4-7-3 *System Key Functions* (page 154).

**Selecting the Menu Items**

Press (touch) a menu item on the screen to select the item.

Menu items allow to make the ON/OFF selection or to call subsequent menu or screen.

**Example 1**

To call the “Maintenance mode menu” by pressing the “Maintenance Mode” on the System Menu screen:

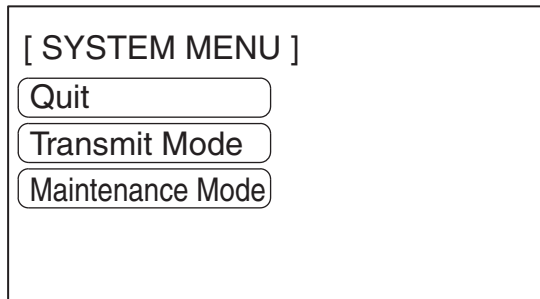

Select “Maintenance Mode”.

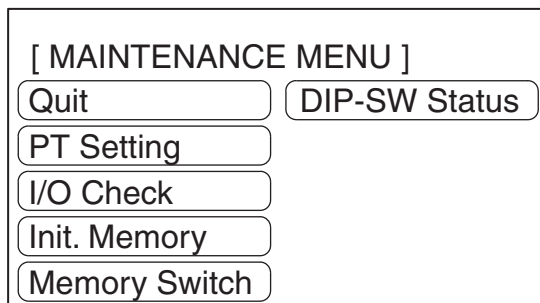

**System Menu Items**

The System Menu items and the functions are as given below.

Menu Item	Function
Quit	The System Menu screen is cleared and the NT20 will return to the RUN mode.
Transmit Mode	The Transmit Mode screen will be displayed to allow the transmission of the screen data between the NT20 and the Support Tool. For the transmission of the screen data, refer to 3-6 Registering the Screen Data (page 102).
Maintenance Mode	The MAINTENANCE MENU will be displayed to allow the maintenance of the NT20 system.

**Switching from the System Menu to the RUN Mode**

The NT20 will exit the System Menu and switch to the RUN mode in the cases described below.

- Selecting “Quit” in the System Menu.
- The screen (touch switches) is not pressed for over 10 seconds.

### 3-4 Initializing Memory

If the NT20 is used for the first time or if the screen data is ruined and the NT20 cannot be normally started, the memory needs to be initialized.

The memory initialization is required in the cases described below.

- When the NT20 is used for the first time or when an error message indicating that the screen data is ruined etc. when the NT20 is started.
  - ➔ Use the “Maintenance Mode” – “Init. Memory” in the System Menu.
- When the NT20 has made a buzzer sound and the screen has disappeared during the start-up or operation.
  - ➔ Use the NT20 DIP SW2-1 “Screen data forced initialize Yes/No”.

When an error has occurred, the error messages such as “Screen data corrupted” will be displayed. For the error messages displayed on the screen, refer to 7-2 *Responding to Displayed Error Messages*.

**Note** Initializing the screen data memory will erase entire screen data registered in the NT20. Make sure that there are backup copies of the screen data on floppy disks before starting the initialization.

- Data of the NT20 to Be Initialized
  - Screen data
  - System memory
  - Memory tables
  - Mark data
  - Direct information

#### 3-4-1 Initialization by Using the System Menu

Initialize the screen data memory by following the procedure given below.

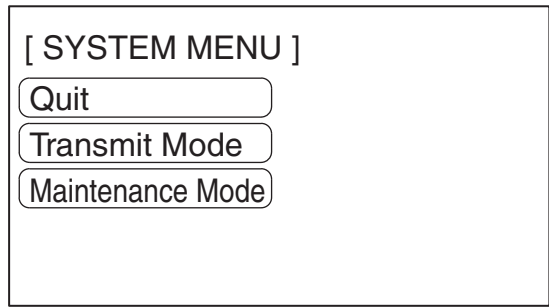

Select “Maintenance Mode”.

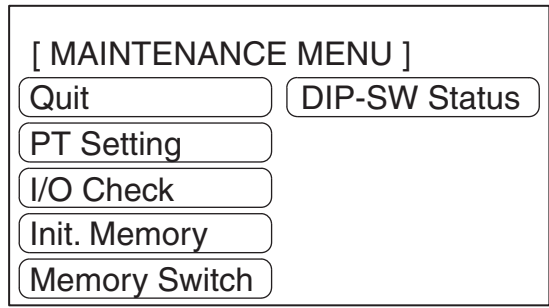

Select “Init. Memory”.



[ INITIALIZE MEMORY MENU ]

Quit

Init. Screen

Select "Init. Screen".



Initialize Screen Memory?

Yes

No

Select "Yes".  
The screen data memory is initialized. During the initialization, the "Initializing" message will be displayed. If "No" is selected, the memory initialization will be canceled and the NT20 returns to the "operation mode".



No direct information is set!

Use the Support Tool  
to set the PT Control Area  
and PT Notify Area

Example:  
Direct information is also initialized. Set the direct information with the Support Tool.

After initialization of the screen data memory, the system enters the operation mode. At this point, nothing is displayed on the screen of the NT20. Return to the System Menu, select the Transmit Mode, and transmit the screen data from the Support Tool.

If the screen data cannot be initialized for any reason, the message "An Error Occur Initializing Memory" is displayed.

### 3-4-2 Initialization by Using the DIP Switch (Forced Initialization)

**Note** Be sure to turn the power OFF before setting the NT20 DIP switch.  
Set the DIP switch as follows to initialize the screen data memory.

- 1,2,3...** 1. Set DIP SW2-1 on the NT20 to ON and turn the power ON or reset the NT20.

Initialize Screen Memory?

Select "Yes".  
The screen data memory is initialized. During the initialization, the "Initializing" message will be displayed.



Initialized the  
 Screen Data Memory.

Turn OFF the DIP Switch 2-1  
 and push the Reset Switch,  
 then return to RUN mode.

2. Turn the NT20 power to OFF.  
3. Set NT20 DIP SW2-1 to OFF and turn the power ON.

**Note** (1) Selecting "No" will cancel the memory initialization. In either case, when changing the system settings or registering screen data, display the system menu after setting DIP switch SW2-1 to the OFF position while the NT20 power is OFF, then switching the power back ON.  
(2) The NT20 DIP SW2-1 is used to set "Screen data forced initialize Yes/No". Setting this to Yes selects "effective", and No "ineffective".

### 3-5 Setting the Conditions of Communications with the Host by Using the Memory Switches

The communications between the NT20 and a PLC/Host are called the host communications.

The NT20 PTs can be connected to the host using the following communications methods.

NT20-ST121-E: Host Link or NT Link (both direct connections)

NT20-ST121-E + NT20-IF001 + NT600M-LB122-V1:  
C200H direct communications (direct connection)

NT20-ST128: RS-232C communications (command control)

With the NT20-ST121-E, the Host Link, 1:1 NT Link, or 1:N NT Link communications method is set using a memory switch. Other settings, such as the band rate and automatic resetting of communications, are also set with memory switches. This section describes the communications condition settings using the memory switches.

#### Memory Switches

The NT20 has the memory areas used to store the PLC connection method, communications conditions, system settings, etc. which can be used as the switches and called the “memory switches”. Since the memory switches use the flash memory, the stored data can be held even when the power supply is turned OFF.

If the memory switch memory is corrupted for any reason, a message will be displayed when the operating mode is changed. Press the Write touch switch and initialize the memory.

#### Setting Functions and the Memory Switch Menu

The memory switches can be set easily by using the memory switch menu in the System Menu.

The following settings can be made with the memory switches. Refer to the subsequent pages and 3-8 *Various System Settings* for details on each setting and function.

- Host Link Method

[ MEMORY SW MENU ] (1/2)		Quit
Comm. Type	Host Link	Page ↓
Key Sound	OFF	
Buzzer Sound	OFF	
Bk light Off	None	
Tool Mode	NT20	
		WRT& EXIT

[ MEMORY SW MENU ] (2/2)		Quit
Automatic Reset	No	Page ↑
Baud Rate	9600bps	
Comm. Port	Port B	
Language	English	
		WRT& EXIT

- NT Link (1:1) Method

[ MEMORY SW MENU ] (1/2)		Quit
Comm. Type	NT Link	Page ↓
Key Sound	OFF	
Buzzer Sound	OFF	
Bk light Off	None	
Tool Mode	NT20	
		WRT& EXIT

[ MEMORY SW MENU ] (2/2)		Quit
Automatic Reset	No	Page ↑
Comm. Port	Port B	
Language	English	
		WRT& EXIT



• NT Link (1:N) Method

[ MEMORY SW MENU ] (1/2)		Quit
Comm. Type	NT Link 1: N	
Key Sound	OFF	Page
Buzzer Sound	OFF	↓
Bk light Off	None	WRT& EXIT
Tool Mode	NT20	

[ MEMORY SW MENU ] (2/2)		Quit
Automatic Reset	No	
Unit No.	7	Page
Comm. Speed	Standard	↑
Comm. Port	Port B	WRT& EXIT
Language	English	

• C200H Direct Communications

[ MEMORY SW MENU ] (1/2)		Quit
Comm. Type	C200H	
Key Sound	OFF	Page
Buzzer Sound	OFF	↓
Bk light Off	None	WRT& EXIT
Tool Mode	NT20S	

[ MEMORY SW MENU ] (2/2)		Quit
Automatic Reset	No	
Language	English	Page
		↑
		WRT& EXIT

• RS-232C (NT20-ST128)

[ MEMORY SW MENU ] (1/3)		Quit
Key Sound	ON	
Buzzer Sound	ON	Page
Bk light Off	10 min	↓
Tool Mode	NT20S	WRT& EXIT
Automatic Reset	Yes	

[ MEMORY SW MENU ] (2/3)		Quit
Data Bits	8 bits	
Stop Bits	1bit	Page
Parity Check	Even	↓
Flow Control	RS/CS	WRT& EXIT
Baud Rate	9600 bps	

[ MEMORY SW MENU ] (3/3)		Quit
LMP Bit Control	Enable	
Comm. Port	Port B	Page
Language	English	↓
		WRT& EXIT

### 3-5-1 Selecting the Host Communications Method

The NT20 can be connected to a PLC by the Host Link, the NT link, or the C200H Direct communications. Either link can be selected by setting the “Comm. Type” memory switch. The factory setting has been made to the “Host link”.

Select the host communications method by the menu operation from the System Menu as described below.

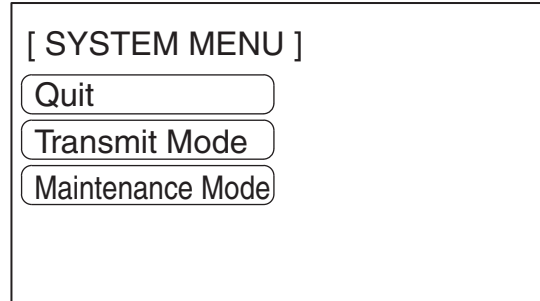

Select “Maintenance Mode”.

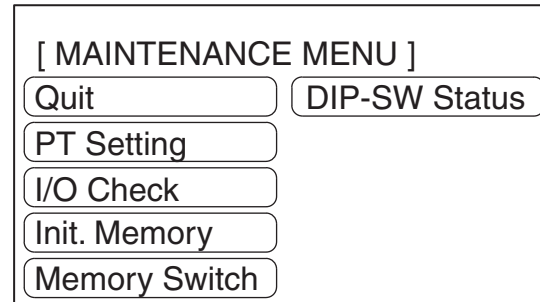

Select “Memory Switch”.

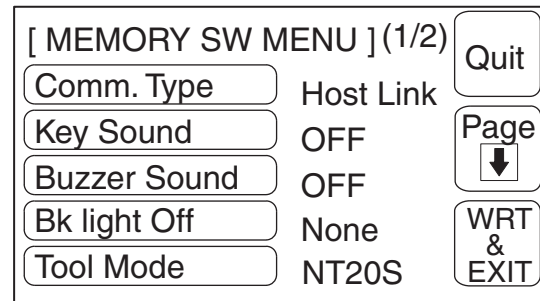

Repeatedly pressing the “Comm. Type” touch switch causes the setting to cycle through the options “Host link”, “NT link”, “NT Link 1:N”, and “C200H” in that order.

To set and quit the menu, press the [WRT&EXIT] touch switch. To quit without setting, press [Quit].

**Note** The communications method must be selected according to the method that the connecting PLC supports.

### 3-5-2 Selecting the Host Communications Port

There are two communications ports in NT20. Either of them can be set for communications. But Port A can be set to communications with either the host (Host link, NT link 1:1, NT link 1:N, RS-232C) or Support Tool and Port B can only be set to communications with the host (Host link, NT link 1:1, NT link 1:N, RS-232C).

**Note** The NT20 can not communicate with both two ports at one time. The factory setting has been made at "Port B". Select the host communications port by the menu operation from the System Menu as described below. (e.g., Host Link)

[ SYSTEM MENU ]	
Quit	
Transmit Mode	
Maintenance Mode	

Select "Maintenance Mode".



[ MAINTENANCE MENU ]	
Quit	DIP-SW Status
PT Setting	
I/O Check	
Init. Memory	
Memory Switch	

Select "Memory Switch".



[ MEMORY SW MENU ] (1/2)		Quit
Comm. Type	Host Link	Page
Key Sound	OFF	↓
Buzzer Sound	OFF	WRT & EXIT
Bk light Off	None	
Tool Mode	NT20S	

Select "Page".



[ MEMORY SW MENU ] (2/2)		Quit
Automatic Reset	No	Page
Baud Rate	9600bps	↑
Comm. Port	Port B	WRT & EXIT
Language	English	

Each time the "Comm. Port" touch switch is pressed, the setting option alternates between "Port A" and "Port B".

To set and quit the menu, press the [WRT&EXIT] touch switch. To quit without setting, press [Quit].

### 3-5-3 Selecting the Host Link Communications Speed

When using the NT20 with the host link, the baud rate of the communications with the PLC can be set. Use the “Baud Rate” switch and select 9600 bps, 19200 bps, 38400 bps, 57600 bps, or 115200 bps.

The factory setting has been made at 9600 bps.

Select the baud rate of the communications with the PLC by the menu operation from the System Menu as described below.

[ SYSTEM MENU ]	
Quit	
Transmit Mode	
Maintenance Mode	

Select “Maintenance Mode”.



[ MAINTENANCE MENU ]	
Quit	DIP-SW Status
PT Setting	
I/O Check	
Init. Memory	
Memory Switch	

Select “Memory Switch”.



[ MEMORY SW MENU ] (1/2)		Quit
Comm. Type	Host Link	Page
Key Sound	OFF	↓
Buzzer Sound	OFF	WRT & EXIT
Bk light Off	None	
Tool Mode	NT20S	

Select “Page”.  
If the host link is not selected, press the “Comm. Type” touch switch and select “Host link”.



[ MEMORY SW MENU ] (2/2)		Quit
Automatic Reset	No	Page
Baud Rate	9600bps	↑
Comm. Port	Port B	WRT & EXIT
Language	English	

Each time “Baud Rate” is pressed, the setting that is displayed will change.

To set and quit the menu, press the [WRT&EXIT] touch switch. To quit without setting, press [Quit].

### 3-5-4 Selecting the NT Link (1:N) Communications Speed

When using the NT20 with the NT Link (1:N), the baud rate of the communications with the PLC can be set. Use the “Comm. Speed” switch and select High or Standard.

Select the speed of the communications with the PLC by the menu operation from the System Menu as described below.

[ SYSTEM MENU ]	
Quit	
Transmit Mode	
Maintenance Mode	

Select “Maintenance Mode”.



[ MAINTENANCE MENU ]	
Quit	DIP-SW Status
PT Setting	
I/O Check	
Init. Memory	
Memory Switch	

Select “Memory Switch”.



[ MEMORY SW MENU ](1/2)		Quit
Comm. Type	NT Link 1:N	Page
Key Sound	OFF	↓
Buzzer Sound	OFF	WRT & EXIT
Bk light Off	None	
Tool Mode	NT20	

Select “Page”.

If the NT Link 1:N is not selected, press the “Comm. Type” touch switch and select “NT Link 1:N”.



[ MEMORY SW MENU ](2/2)		Quit
Automatic Reset	No	Page
Unit No.	7	↑
Comm. Speed	Standard	WRT & EXIT
Comm. Port	Port B	
Language	English	

Each time the “Comm. Speed” touch switch is pressed, the setting option alternates between “High” and “Standard”.

To set and quit the menu, press the [WRT&EXIT] touch switch. To quit without setting, press [Quit].

### 3-5-5 Selecting Unit Numbers

When using NT20 with the NT link (1:N) communications method, set unit numbers.

When using NT link (1:N), unit numbers are used to identify each of the multiple PTs connected to a single PLC port. Set a different unit number for each of the PTs connected to the port.

The unit numbers that can be set differ according to the type of host PLC as follows.

C200HE: Unit Nos. 0 to 3

C200HG, C200HX: Unit Nos. 0 to 7

Set the unit numbers by following the menu operation from the System Menu described below.

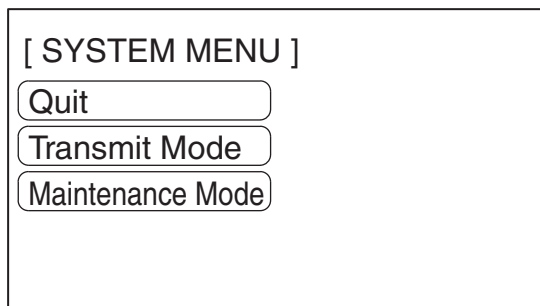

Select "Maintenance Mode".

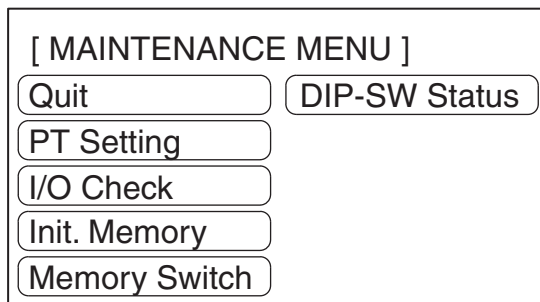

Select "Memory Switch".

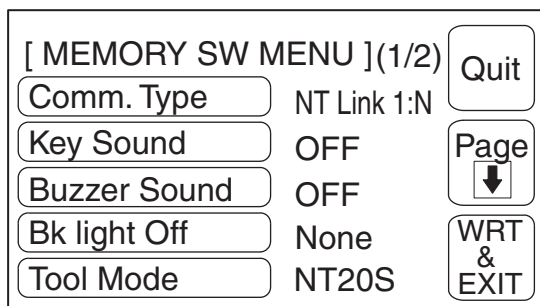

Press the "Comm Type" touch switch to select "NT link (1:N)".

Select "Page".



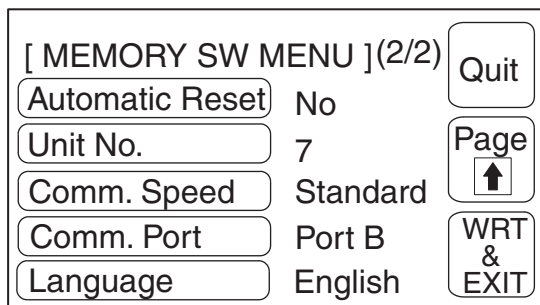

Repeatedly pressing the “Unit No.” touch switch cycles through the numbers that can be set.

To set and quit the menu, press the [WRT & EXIT] touch switch. To quit without setting, press [Quit]. The run mode will be established.

### 3-5-6 Selecting the Automatic Reset Function

The “Automatic Reset” memory switch is used to set whether or not the communications are automatically reset after the occurrence of a communications error.

The factory setting has been made at “No”.

Select the baud rate of the communications with the PLC by the menu operation from the System Menu as described below.

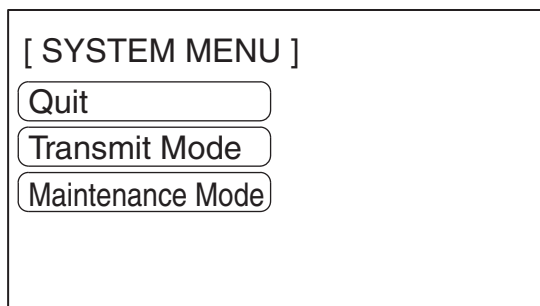

Select “Maintenance Mode”.

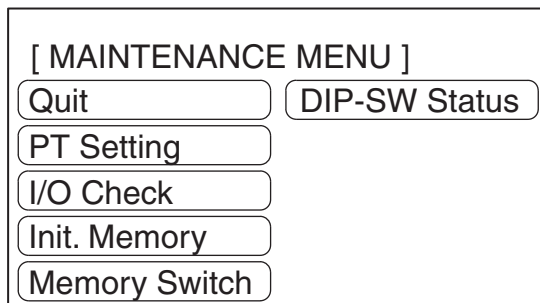

Select “Memory Switch”.

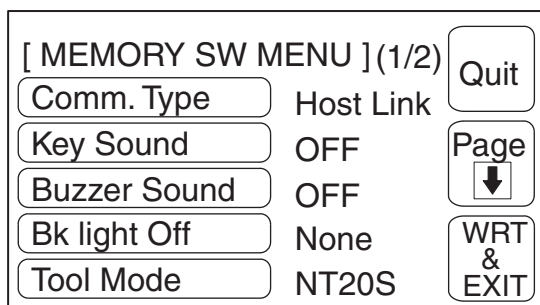

Select “Page”.

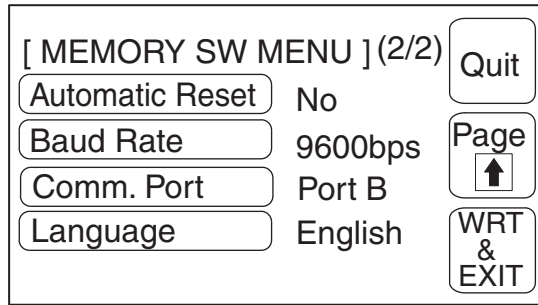

Each time the “Automatic Reset” touch switch is pressed, the setting option “Yes” alternates with “No”.

To set and quit the menu, press the [WRT&EXIT] touch switch. To quit without setting, press [Quit].

- “No”: If a communications error has occurred, corresponding error message is displayed and the operation stops.
- “Yes”: If a communications error has occurred, corresponding error message will not be displayed and the operation will be automatically reset.

### 3-5-7 Setting RS-232C Communications Conditions (NT20-ST128)

When using an NT20-ST128 (using the RS-232C interface for communications with the host), set the following communications conditions.

- Data Bits
- Stop Bits
- Parity Check
- Flow Control
- Baud Rate

Set the same communications conditions at the host and the NT20. You are recommended to set the highest baud rate that can be used by the host and NT20.

The factory settings are as follows:

- Data Bits 8 bits
- Stop Bits 2 bits
- Parity Check Even
- Flow Control None
- Baud Rate 9600 bps

Set the conditions of the communications with the Host by the menu operation from the System Menu as described below.

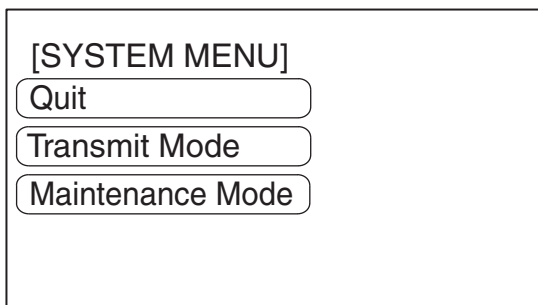

Select “Maintenance Mode”.





[MAINTENANCE MENU]	
Quit	DIP-SW Status
PT Setting	
I/O Check	
Init. Memory	
Memory Switch	

Select "Memory Switch".



[MEMORY SW MENU] (1/3)		Quit
Key Sound	ON	Page
Buzzer Sound	ON	↓
Bk light Off	10 min	WRT & EXIT
Tool Mode	NT20S	
Automatic Reset	Yes	



[MEMORY SW MENU] (2/3)		Quit
Data Bits	8 bits	Page
Stop Bits	1 bit	↓
Parity Check	Even	WRT & EXIT
Flow Control	RS/CS	
Baud Rate	19200 bps	



[MEMORY SW MENU] (3/3)		Quit
LMP Bit Control	Enable	Page
Comm. Port	Port B	↓
Language	English	WRT & EXIT

The selected option displayed when the corresponding touch switch is pressed: the options for each switch are indicated below:

- Data Bits: 7 bits/8 bits
- Stop Bits: 1 bit/2 bits
- Parity Check: None/Even/Odd

- Flow Control: None/RS/CS/XON/XOFF
- Baud Rate: 2400 bps/4800 bps/9600 bps/19200 bps
- LMP Bit Control: Enable/Disable

**Note** Use the same condition settings as set for the host. It is recommended that the highest baud rate possible is selected for both the host and the NT20.

For details on lamp bit control, refer to *3-8 Various System Settings* on page page 106.

### 3-6 Registering the Screen Data

The screen data is created by using the Support Tool and registered to the NT20 screen data memory. This section describes the procedure to register the screen data to the NT20. For the screen data creation and the Support Tool operation, refer to the *NT-series Support Tool Operation Manual* (Cat. No. V061).

**Note** The screen data transmission speed can be increased by setting “Hi speed” for “Communications Mode” on the Tool Settings screen of the Support Tool.

#### Unit of Screen Transmission – Transmission in File Units

The NT20 uses several screens which are switched on its display. The screen data of one NT20 unit corresponds to the files created by using the Support Tool. Select a file which contains the screen data to be transmitted when selecting the screen data to be transmitted to the NT20 so that the required screen data can be transmitted to the NT20.

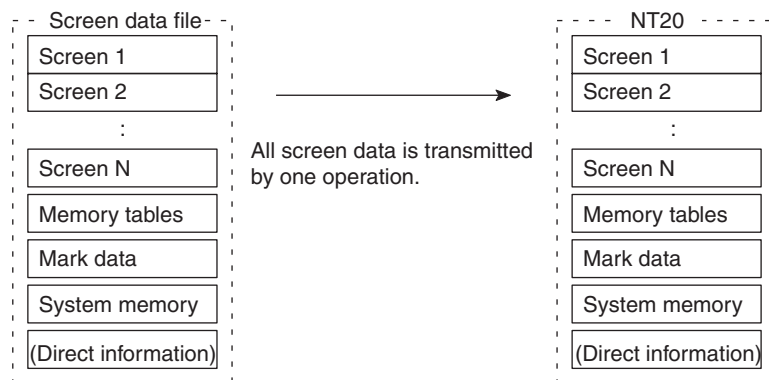

When the screen data is transmitted from the Support Tool to the NT20, the screen data already existing in the NT20 will be erased.

If an error message and the System Menu are displayed immediately after the NT20 has been started, the screen data memory needs to be initialized.

#### Data Transmission in Screen Units

The NT20 allows the transmission of data for specified screens. By selecting the screen number of the screen to be transmitted using the Support Tool, it is possible to transmit the required screen only to the NT20 (it is also possible to transmit multiple screens in a batch).

When changes have also been made to the memory table entries or direct connection information, transmit the changed data to the NT20 too, for example by using transmission in screen units.

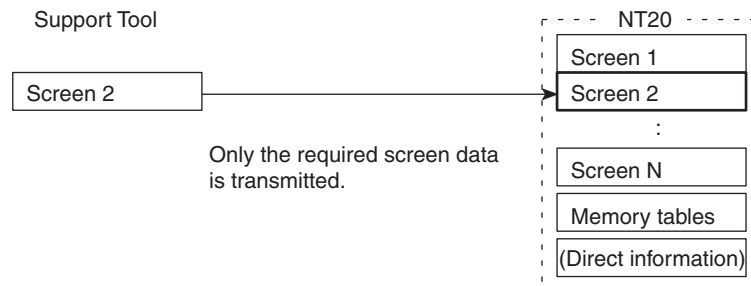

**Caution** When screen data transmission is in screen units, if there is data other than screen data, for example memory table or direct access changes, transmit this data also.

**Note** When screen data is transmitted to an NT20, it is written into a free area of the memory without overwriting the existing data. This means that if data transmission in screen units is performed frequently, there will come a time when there is no more free area in the memory and further transmission is impossible. If this happens, transmit the data in file units to reorganize the contents of the NT20 memory.

**Transmitting the Screen Data from the Support Tool**

To transmit the screen data from the Support Tool to the NT20, connect the NT20 to the computer on which the Support Tool is being used, and follow the procedure below.

**Note** When the screen data transmission is attempted, the screen data memory in the NT20 is automatically initialized before new screen data is transmitted. It is not necessary to initialize the screen data memory by using the menu before the screen data transmission.

The NT20-ST121-E/ST128 uses the same connector for screen data transmission and connection to the Host. If this connector is currently connected to the host, disconnect the cable from it and connect it to the Support Tool (personal computer) before attempting screen data transmission.

- 1,2,3...**
1. Connect the NT20 to a PLC in which the Support Tool has been installed and turn on the power to the NT20.
  2. Turn ON the computer and start up the Support Tool.
  3. Enter the "Transmit Mode" by operating the menu of the NT20 as described below.

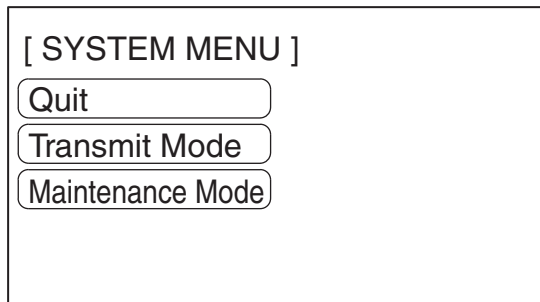

Select "Transmit Mode".

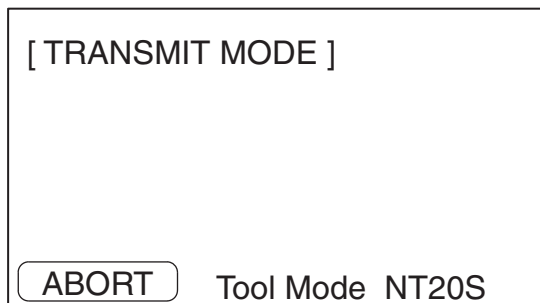

The transmit mode is established. When using an NT20, the "Support Tool mode" setting will be displayed on the bottom line of the screen, as shown in the figure to the left.

4. Select a screen data to be transmitted to the NT20 in the File Selection screen of the Support Tool, and press the Send key.
5. The NT20 will display the following screen when the screen data is being transmitted.

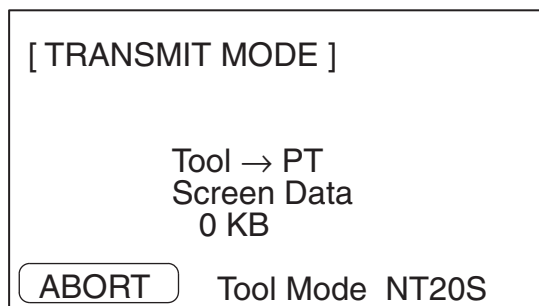

6. When the screen data transmission is completed, the Support Tool will display the following screen.

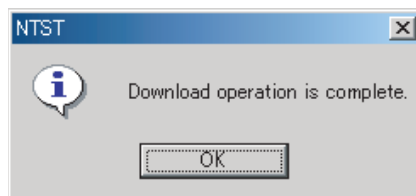

7. Press any key on the Support Tool to return to the File Selection screen.  
 8. Pressing the ABORT touch switch in the Transmit Mode screen of the NT20 will exit the Transmit Mode and enter the RUN Mode.

**Note** Press the “Abort” touch switch on the NT20 when the screen data transmission is completed. Unless this touch switch is pressed, the screen data will not be correctly registered. If the “Abort” touch switch is pressed during transmission, the screen data will not be correctly registered.

If screen data cannot be transmitted from the Support Tool, confirm normal communications between the NT20 and the Support Tool (Personal computer). Use the tool communications check function in the Maintenance Mode of the NT20 to check communications with the Support Tool. Refer to *Checking the Communications with the Support Tool* on page 116.

### Precautions to Be Observed during Screen Data Transmission

When any of the following or a system error occurs during the screen data transmission, the transmitted screen data will not be registered correctly to the NT20. If an error message is displayed in the System Menu and the RUN Mode cannot be selected, the screen data memory needs to be initialized.

- The power to the NT20 is interrupted or reset.
- The power to the computer on which the Support Tool is running is interrupted or reset.
- The cable connecting the NT20 to the computer on which the Support Tool is running is interrupted or reset.
- The “Abort” touch switch on the NT20 screen is pressed to end the transmission.
- The ESC key on the Support Tool is pressed to end the transmission.

When the power to the NT20 is turned ON or reset, the screen data is checked. However, if any of the above occurs during the screen data transmission, the screen may disappear and other unexpected problems may occur.

In the case of such problems, set DIP SW2-1 to ON to initialize the memory.

For the memory initialization by using the DIP switch, refer to the *3-4-2 Initialization by Using the DIP Switch (Forced Initialization)* on page 90.

## 3-7 Starting the Operation

After completing the screen data transmission and setting the communications conditions, connect the NT20 to the Host and start operation.

### Switching to RUN Mode

Press the Quit touch switch in the System Menu. The start-up screen in the RUN mode will be displayed.

If the NT20 has failed to start correctly; e.g., the start-up screen is not displayed, an error message is displayed, or the screen is not displayed at all, refer to *7-2 Responding to Displayed Error Messages* and take appropriate action.

**Note** When using Host Link, NT Link, or C200H Direct communications, the screen displayed on startup is the one specified in the screen switch setting of the PT status control area.

When using an NT20-ST128, the startup screen is specified with the Support Tool when creating the screen data. If no startup screen is specified, screen No.1 becomes the startup screen. If no screen data is registered for the startup screen, the error message "Screen not registered" is displayed. For details on screen numbers, see *4-3 Screen Display* on page 140.

### Confirming the Communications between the NT20 and the PLC/Host

When using the NT20-ST128, use the RS-232C communications check function in Maintenance Mode to confirm normal communications between the NT20 and the host. Refer to *Checking the Communications with the Host (NT20-ST128)* on page 117.

When using the NT20, run the Host program and check that the following operations are executed normally.

- Confirm that the NT20 screens switch according to the Host program execution.

If the screens do not switch correctly, check the connection between the NT20 and the Host and also check the settings.

Refer to *SECTION 2 Hardware Settings and Connections*.

- Confirm that the information selected by the NT20 touch switches has been correctly sent to the PLC by displaying the information of bits and words by using a Programming Device (e.g., CX-Programmer). If the information sent from the NT20 has not been correctly received by the PLC, check the screen data settings (specifically the switch settings).

For details on the screen data creation, refer to the *NT Support Tool for Windows Operation Manual* (Cat. No. V061).

### 3-8 Various System Settings

The NT20 can set a variety of functions to the memory switches which are convenient during the operation. This section describes the memory switch settings related to the operation environment.

#### 3-8-1 Setting the Key Press Sound

Whether or not the key press sound is given when the NT20 touch switch is pressed can be set with the memory switch.

The factory setting has been set to give the key press sound when the touch key is pressed.

Set the key press sound by the menu operation from the System Menu as described below.

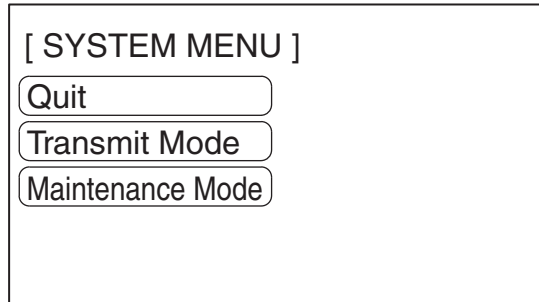

Select "Maintenance Mode".

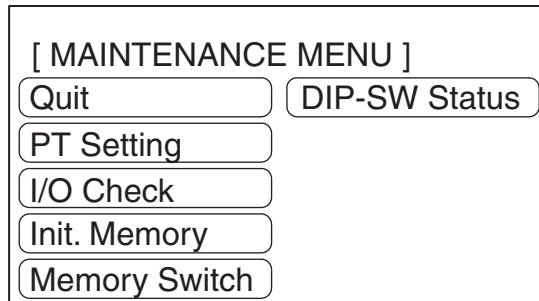

Select "Memory Switch".

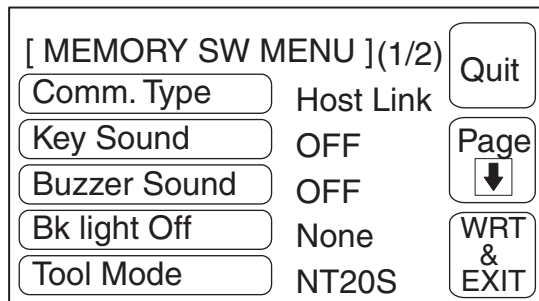

Each time the "Key Sound" touch switch is pressed, the setting option "ON" alternates with "OFF".

To set and quit the menu, press the [WRT & EXIT] touch switch. To quit without setting, press [Quit].

- ON: The key press sound will be given for 0.2 second when a touch switch is pressed.
- OFF: The key press sound will not be given when a touch key is pressed.

## 3-8-2 Using the Buzzer

The NT20 can set a buzzer to indicate the occurrence of an emergency or an NT20 error.

### Setting the Buzzer

Except when the buzzer has been set so as not to sound at all, the buzzer will sound when an error occurs. To set the buzzer to sound in other cases, the following two procedures can be used.

- Controlled by the Host

It is possible to control the NT20 from the Host to sound the buzzer during the operation.

Refer to *5-4 NT20 Status Control* on page 203.

- Set the buzzer as a screen data attribute by using the Support Tool.

When creating the screen data by using the Support Tool, set the buzzer as a screen attribute so that the buzzer will sound. When the screen in which this attribute has been set is displayed, the NT20 will give the buzzer sound.

**Note** If the control by the Host and the display of the screen in which the buzzer attribute has been set are executed simultaneously, the priority is given to the control by the Host. Refer to the NT Support Tool for Windows Operation Manual (Cat . No.V061-E1-□).

### Stopping the Buzzer

The buzzer sound can be stopped by the following operation.

- Control by the Host
- Switch the screen to a screen which does not have a buzzer attribute.
- Press the touch switch to which the buzzer stop attribute has been set.

**Note** If a buzzer stop attribute has been set to a touch switch created on the screen in which the buzzer attribute has been set, such touch switch can be used to stop the buzzer sound. For details on setting buzzer attributes for touch switches, see *Allocation of System Key Functions* on page 154.



**Types of Buzzer Sounds**

The following buzzer sounds can be set.

- Continuous sound: The buzzer continues to sound.
- Intermittent sound: The buzzer sounds intermittently at constant intervals.

**Note** If both the continuous buzzer and the intermittent buzzer are instructed by the Host, the continuous buzzer will sound.

**Setting the Buzzer**

Use the memory switches to set whether or not the buzzer sounds when the buzzer sound has been instructed by the Host or with a screen attribute or when an error has occurred.

The factory setting is “ON”, which means that the buzzer will sound when a command is received from the host, when a screen for which the buzzer attribute is set is displayed, and when errors occur.

Set the buzzer sound by the menu operation from the System Menu as described below.

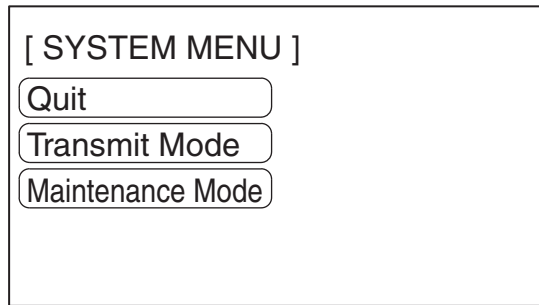

Select “Maintenance Mode”.

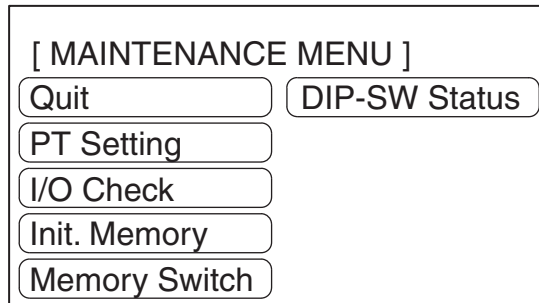

Select “Memory Switch”.

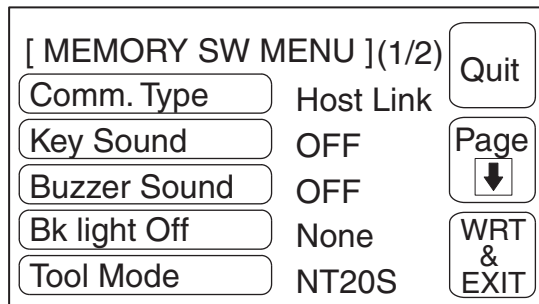

Repeatedly pressing the “Buzzer Sound” touch switch cycles through the setting options “ON”, “ERR ON”, and “OFF”, in that order.

To set and quit the menu, press the [WRT&EXIT] touch switch. To quit without setting, press [Quit].

- OFF: The buzzer will not sound at all during the operation.
- When “ON” is set, the buzzer will sound when a command is received from the host, when a screen for which the buzzer attribute is set is displayed, and when errors occur.
- When “ERR ON” has been set, the buzzer will sound only when an error has occurred.

**Note** The buzzer will sound when “Buzzer check” is selected in the Maintenance Mode regardless of the buzzer setting.

### 3-8-3 Backlight OFF Function

The NT20 has a function that turns off the backlight of the LCD panel to maximize its service life if no operation is performed for a certain period of time.

#### Turning ON the Backlight

When a touch switch on the NT20 is pressed or a screen is switched or redisplayed by the PLC when the backlight is off by the backlight off function, the backlight will turn on. Any changes of numeric values or characters displayed on the screen will not effect the backlight to turn on again.

#### Setting the Backlight OFF Function

Use the memory switches to set whether or not the backlight off function is used and the length of time to turn off the backlight.

The factory setting has been made so as to turn off the backlight if no operation has been performed for 10 minutes.

Set the backlight off function by the menu operation from the System Menu as described below.

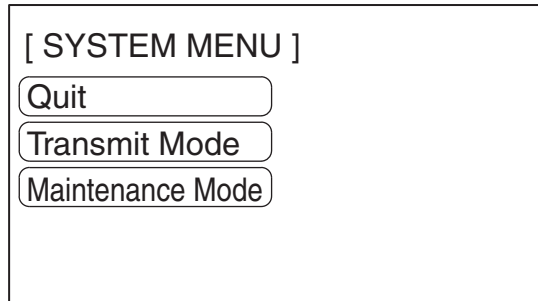

Select “Maintenance Mode”.

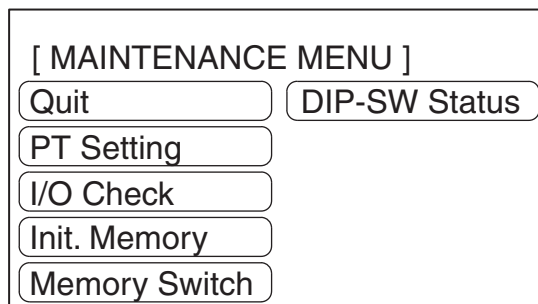

Select “Memory Switch”.

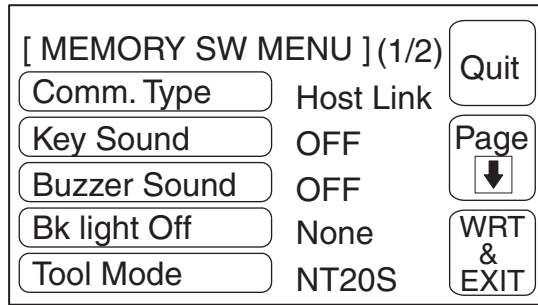

Repeatedly pressing the “BK light Off” touch switch cycles through the setting options “10 min”, 1 hour, and None, in that order.

To set and quit the menu, press the [WRT&EXIT] touch switch. To quit without setting, press [Quit].

- None: The backlight off function is not used. As long as no operation is performed, the same screen remains to be displayed.
- 10 minutes: The backlight will be turned off when no operation has been performed for 10 minutes.
- 1 hour: The backlight will be turned off when no operation has been performed for 1 hour.

**Caution** Do not press touch switches carelessly while the backlight is off or while nothing is displayed on the screen. Otherwise the system may operate unpredictably. Only press touch switches after confirming system safety.

**Note** Continuous display of the same pattern for an extended time (as a guide, about 1 hour) will lead to the formation of an afterimage. In order to prevent this, either use the screen saver function or periodically switch screens.

### 3-8-4 Language Function

The language selection items will be different according to the DIP-SW2-2. When DIP-SW2-2 is pushed to ON, the language is fixed to English. That is, user can't choose other language but English. When DIP-SW2-2 is pushed to OFF, the languages can be switched in this language item in Memory SW Menu. Both Japanese and English are available.

DIP-SW2-2 is ON.

(Host link)

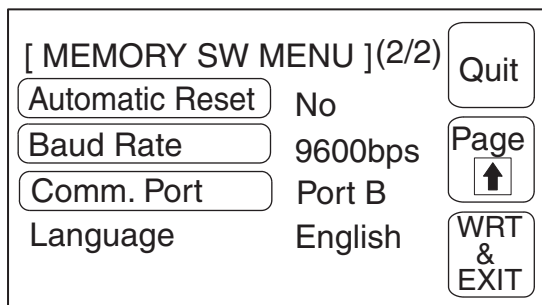

(NT Link (1:1))

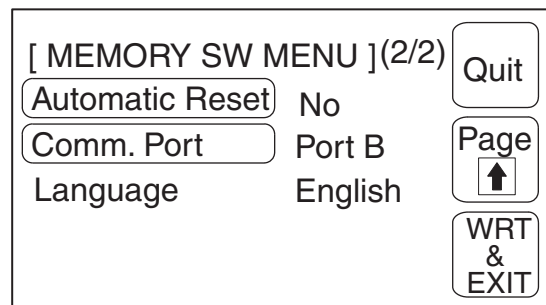

(NT Link (1:N))

[ MEMORY SW MENU ](2/2)		Quit
Automatic Reset	No	Page ↑
Unit No.	7	
Comm. Speed	Standard	WRT & EXIT
Comm. Port	Port B	
Language	English	

DIP-SW2-2 is OFF.

(Host link)

[ MEMORY SW MENU ](2/2)		Quit
Automatic Reset	No	Page ↑
Baud Rate	9600bps	
Comm. Port	Port B	WRT & EXIT
Language	English	

(NT Link (1:1))

[ MEMORY SW MENU ](2/2)		Quit
Automatic Reset	No	Page ↑
Comm. Port	Port B	
Language	English	WRT & EXIT

(NT Link (1:N))

[ MEMORY SW MENU ](2/2)		Quit
Automatic Reset	No	Page ↑
Unit No.	7	
Comm. Speed	Standard	WRT & EXIT
Comm. Port	Port B	
Language	English	

### 3-8-5 Support Tool Mode Setting (NT20-ST121-E)

By setting “Tool Mode” to “NT20M”, the NT20 can be used in the same way as the conventional NT20M/NT20S, and it becomes possible to use the NT Series Support Tool (version 2.□).

However, the following restrictions apply when “NT20M” is set:

- Version 5 of the direct connection function cannot be used.
- The PT type setting must be “NT20M”.
- High-speed data transfer with the Support Tool is not possible.
- It is not possible to transfer the direct information alone.
- When screen data transmission is in screen units, simultaneous transmission of multiple screens is not possible. An attempt to transmit multiple screens may destroy the screen data.
- When screen data transmission is in screen units, transmission with verification set is not possible.
- The image data memory must be initialized before starting transfer in file units.
- Screen data for RS-232C communications cannot be used.

Set the Support Tool mode by the menu operation from the system menu shown below.

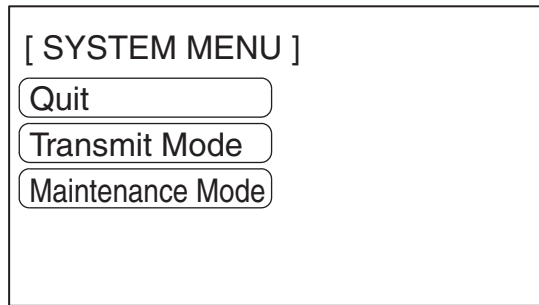

Select "Maintenance Mode".

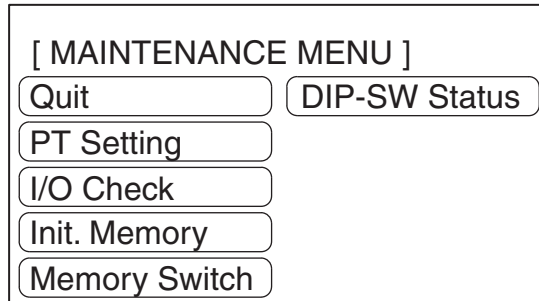

Select "Memory Switch".

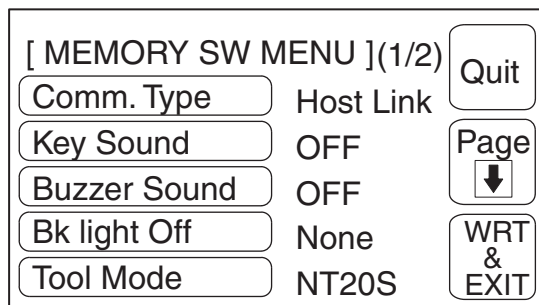

Each time the "Tool Mode" touch switch is pressed, the setting option alternates between "NT20", "NT20S", and "NT20M". (The figure to the left shows the NT20-ST121□-E screen.)

To quit after setting the selected item, press the WRT & EXIT touch switch. To quit without setting, press the Quit touch switch. The NT20 will enter the RUN mode.

- When "NT20M" or "NT20S" is set, the NT20M/NT20S compatible mode is established and the terminal can be used as an NT20M/NT20S.
- When "NT20" is set, the terminal can be used as an NT20.

**Note** Before uploading screen data from the NT20 to the Support Tool, confirm that the model information for the screen data in the NT20 and the Tool's transfer mode match. If they do not match, the upload may fail or data may change, preventing correct operation.

### 3-8-6 Lamp Bit Control (NT20-ST128)

When using the NT20-ST128 (using the RS-232C interface for communications with the host), you can select whether lamp status is controlled by bit designation or not.

The factory setting for this function is "Enable" (lamps numbered 0 to 31 controlled by bits).

Set the lamp bit control function by the menu operation from the System Menu as described below.

[ SYSTEM MENU ]

Quit
Transmit Mode
Maintenance Mode

Select "Maintenance Mode".



[ MAINTENANCE MENU ]

Quit	DIP-SW Status
PT Setting	
I/O Check	
Init. Memory	
Memory Switch	

Select "Memory Switch".



[MEMORY SW MENU] (1/3)

Key Sound	ON	Quit
Buzzer Sound	ON	Page
Bk light Off	10 min	↓
Tool Mode	NT20S	WRT & EXIT
Automatic Reset	Yes	

Select "Page down".



[MEMORY SW MENU] (2/3)

Data Bits	8 bits	Quit
Stop Bits	1 bit	Page
Parity Check	Even	↓
Flow Control	RS/CS	WRT & EXIT
Baud Rate	19200 ps	

Select "Page down".



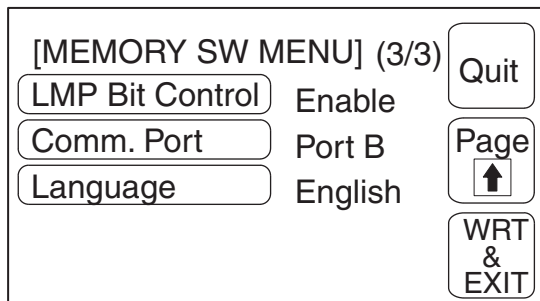

Each time the “LMP Bit Control” touch switch is pressed, the setting option “Enable” alternates with “Disable”.

To set and quit the menu, press the [WRT&EXIT] touch switch. To quit without setting, press [Quit].

- When “Disable” is set, the control of lamp display status by bits is not possible. The lamps numbered 0 to 31 can be controlled only by specifying lamp numbers.
- When “Enable” is set, lamp control by bits is possible. This means that the lamps numbered 0 to 31 can be controlled by specifying either lamp numbers or bits. However, it is not possible to make “lit”/“flashing” status selections by specifying lamp numbers: the selection made when the screen data was created remains effective.

### 3-9 System Maintenance

The NT20 has the self maintenance functions such as I/O check and setting status check.

#### 3-9-1 I/O Check

The I/O operations for the following items of the NT20 are checked by the I/O check function.

- Touch Switch
- Communications with the Support Tool
- Communications with the Host (NT20-ST128 RS-232C only)
- LCD
- LED Check
- The Screen Data Memory
- Buzzer

#### Checking the Touch Switches

Execute a touch switch check by the menu operation from the System Menu as described below.

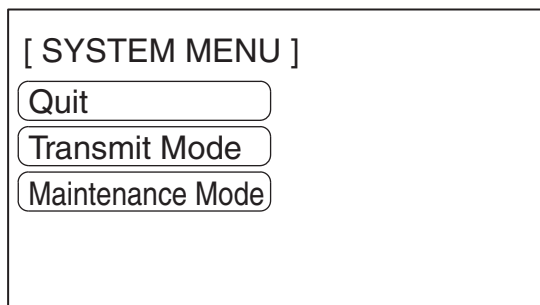

Select "Maintenance Mode".

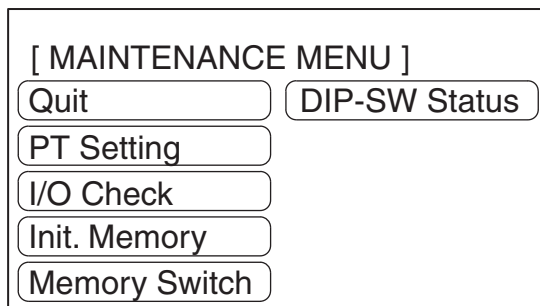

Select "I/O Check".

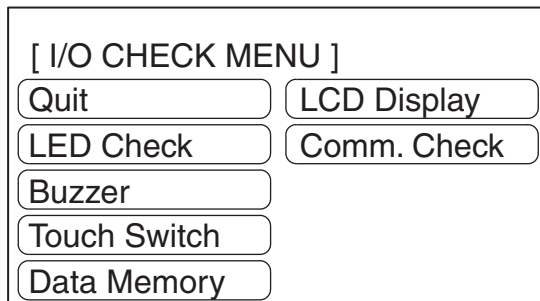

Select "Touch Switch".



A panel of 6-row x 12-column touch switches, each switch sized 1 x 1 cm, will be displayed.

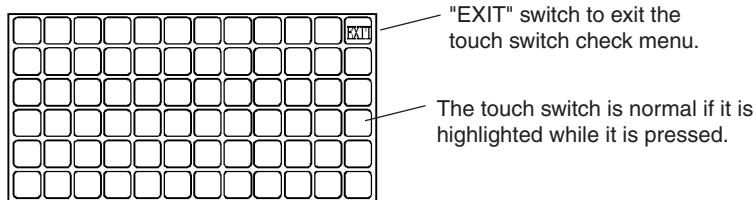

- Press a touch switch on the screen. If the touch switch is highlighted while it is pressed, the touch switch is normally functioning.
- When the check is finished, press the EXIT touch switch. The I/O check menu will be redisplayed.

**Note** If memory switch setting for the key press sound has been made for ON, the key press sound will be made when a touch switch is pressed. The status of touch switches pressed during an I/O check is not sent to the host.

**Checking the Communications with the Support Tool**

Execute a NT20-to-Support Tool communications check by the menu operation from the System Menu as described below.

The NT20-ST121-E/ST128 uses the same connector (Port A) for connection to the Support Tool and connection to the Host. If this connector is currently connected to the host, disconnect the cable from it and connect it to the Support Tool (personal computer) before attempting screen data transmission.

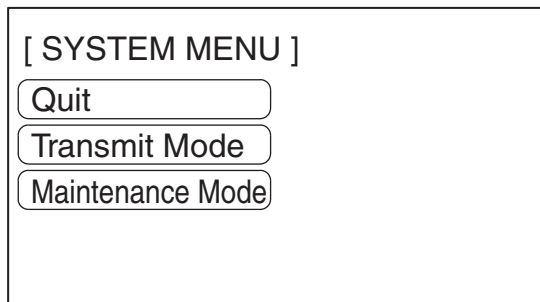

Select "Maintenance Mode".

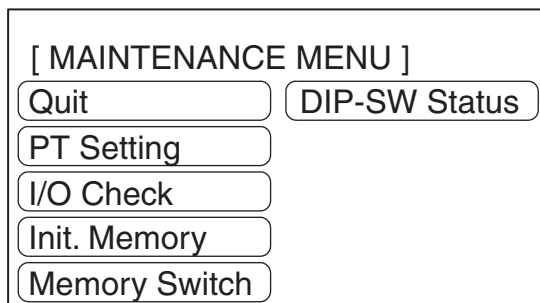

Select "I/O Check".

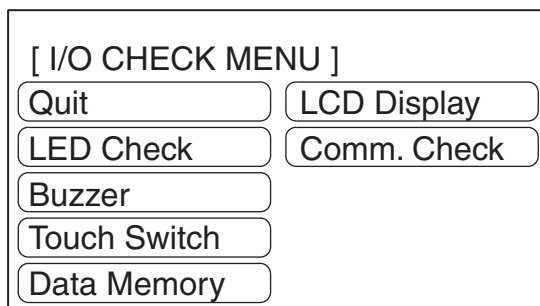

Select "Comm. Check".

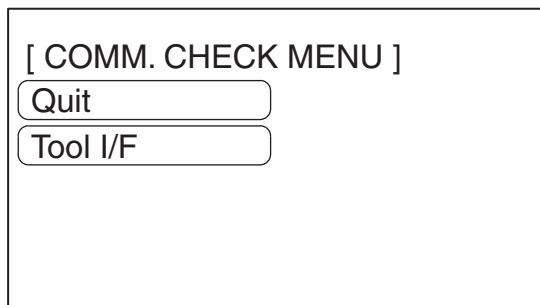

Select "Tool I/F".

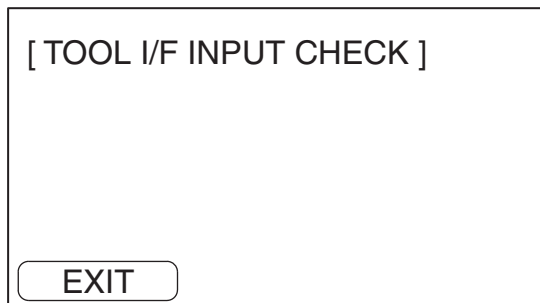

The data received from the connected Support Tool are displayed in hexadecimal numbers.

When the check is finished, press the Exit touch switch. The NT20 will enter the I/O CHECK MENU.

**Checking the Communications with the Host (NT20-ST128)**

Execute a NT20-to-Host communications check by the menu operation from the System Menu as described below.

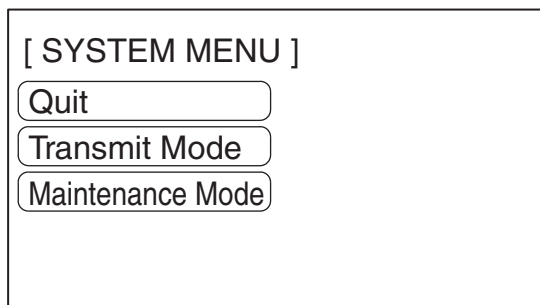

Select "Maintenance Mode".



[ MAINTENANCE MENU ]

Quit	DIP-SW Status
PT Setting	
I/O Check	
Init. Memory	
Memory Switch	

Select "I/O Check".



[ I/O CHECK MENU ]

Quit	LCD Display
LED Check	Comm. Check
Buzzer	
Touch Switch	
Data Memory	

Select "Comm.Check."



[ COMM. CHECK MENU ]

Quit
Tool I/F
RS-232C I/F



[ RS-232C I/F INPUT MENU ]

Exit
------

When the check is finished, press the EXIT touch switch. The NT20 will enter the RUN mode.

**Checking the LCD**

Check the NT20 LCD by using the menu operation from the System Menu as described below.

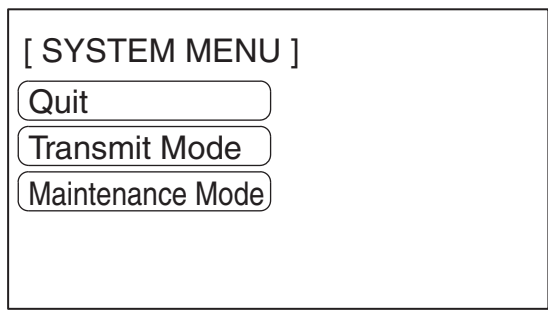

Select "Maintenance Mode".

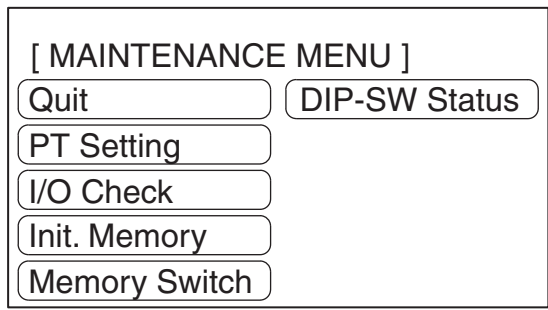

Select "I/O Check".

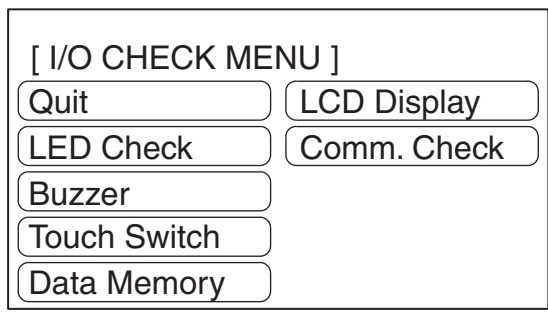

Select "LCD Display".

Select "RS-232C I/F".

- The LCD displays dots (segments of the screen) line by line beginning with the top left corner. If all the dots are displayed normally, the NT20 will enter the I/O CHECK MENU after all the dots have been turned off.
- To cancel the LCD indication check, press any touch switch (anywhere) on the screen. The I/O Check Menu will be redisplayed.

**Checking the Buzzer**

Check the NT20 buzzer by using the menu operation from the System Menu as described below.

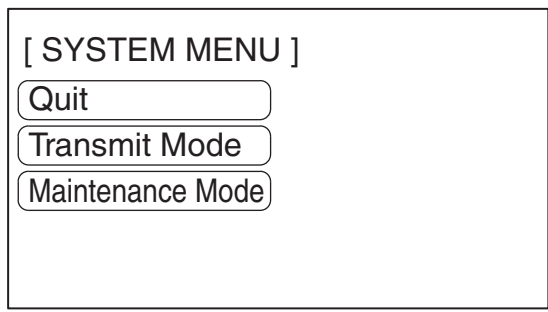

Select "Maintenance Mode".



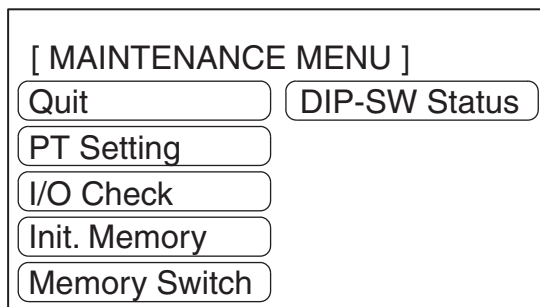

Select "I/O Check".

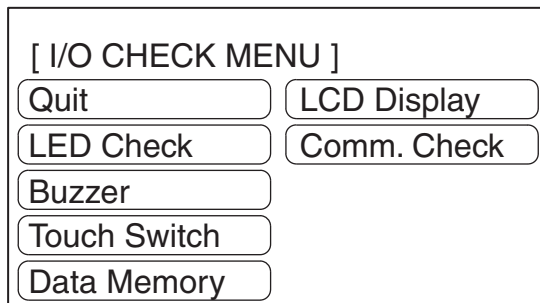

Select "Buzzer".

- If the buzzer function is normal, the continuous buzzer sound will be made.
- To stop the buzzer, press "EXIT" touch switch in the buzzer check screen. The NT20 will enter the I/O CHECK MENU.

**Note** Though memory switch setting for the buzzer has been made for OFF, the buzzer will sound when the buzzer check is executed.

**Checking the LED**

Check the LED by using the menu operation from the System Menu as described below.

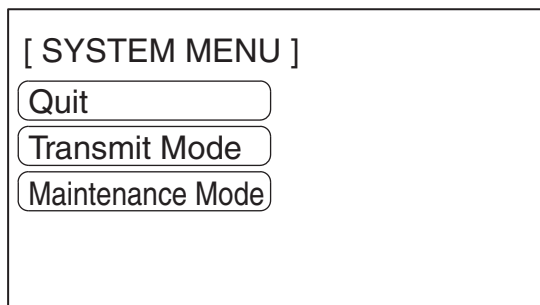

Select "Maintenance Mode".

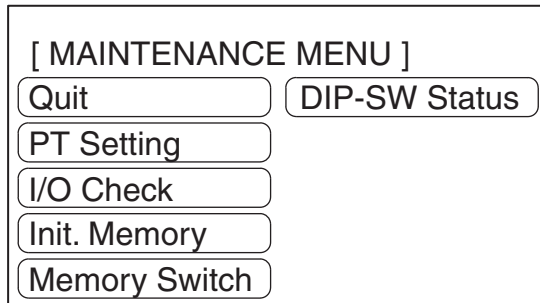

Select "I/O Check".

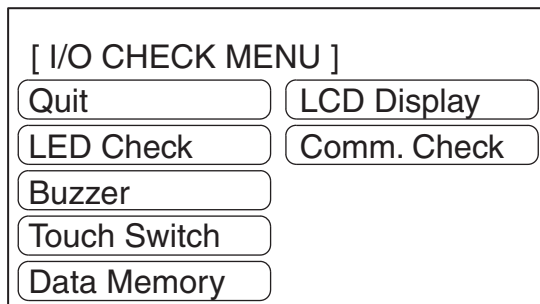

Select "LED Check".

The "RUN" LED on the front face of the NT20 will flash. Flashing cycle is about 1 s (500 ms ON and 500 ms OFF).

- To quit the LED check, press the "EXIT" touch switch. The NT20 will enter the I/O CHECK MENU.

### Checking the Screen Memory

Check the screen memory by using the menu operation from the System Menu as described below.

**Note** When the screen data memory is checked, the memory is initialized and all the screen data is lost. Check that the screen data has been backed up using the Support Tool before executing a screen data memory check.

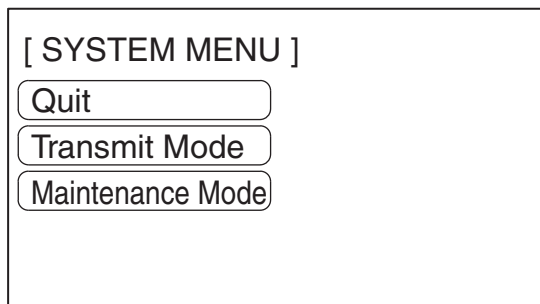

Select "Maintenance Mode".

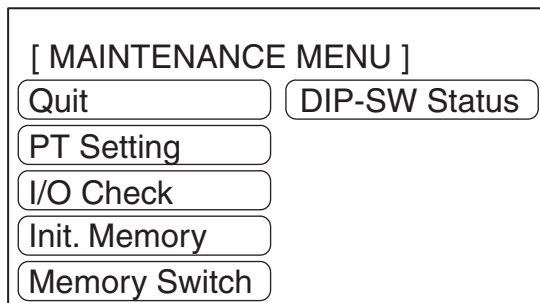

Select "I/O Check".



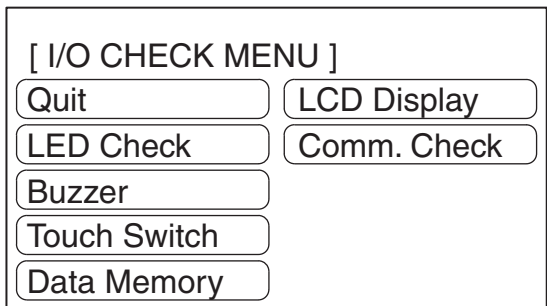

Select "Data Memory".

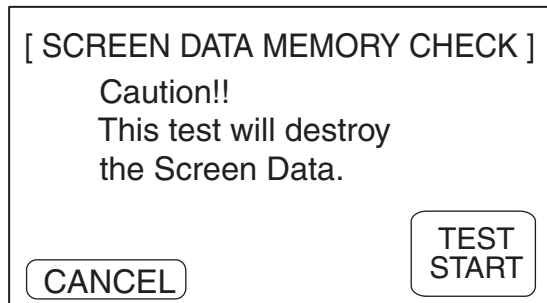

Press "TEST START".  
Pressing "Cancel" will  
cancel the memory  
check.

The screen memory check will start.

While the screen memory is checked, the "Memory checking..." message will be displayed.

- If the memory check has been normally completed, the "Memory is OK" message will be displayed.
- To quit the memory check, press the "Cancel" touch switch. The NT20 will enter the I/O CHECK MENU.
- If the "Memory error!" message is displayed, the screen data memory may have been used up to its service life or there may be a hardware fault. In that case, initialize the screen data memory and check the memory again. If the same error message is displayed again, consult the OMRON Service Center.

### 3-9-2 Checking the PT Setting

Display the NT20 settings by using the menu operation from the System Menu as described below.

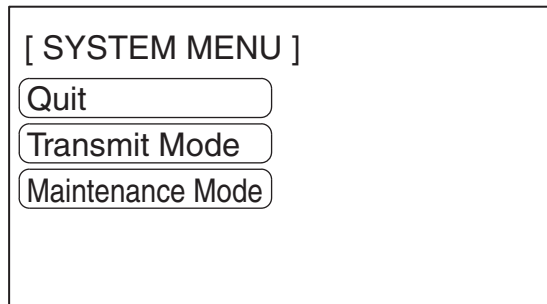

Select "Maintenance Mode".



[ MAINTENANCE MENU ]

Quit      DIP-SW Status

PT Setting

I/O Check

Init. Memory

Memory Switch

Select "PT Setting".



(Host link)

[ PT SETTING ]

PT Control Area    DM0000

PT Notify Area    DM0010

Comm. Type        Host Link

Baud Rate         9600bps

EXIT

(NT Link (1:1))

[ PT SETTING ]

PT Control Area    DM0000

PT Notify Area    DM0010

Comm. Type        NT Link

EXIT

(NT Link (1:N))

[ PT SETTING ]

PT Control Area    DM0000

PT Notify Area    DM0010

Comm. Type        NT Link 1:N

Unit No.            7

EXIT

(C200H)

[ PT SETTING ]

PT Control Area    DM0000

PT Notify Area    DM0010

Comm. Type        C200H

Unit No.            0

EXIT

(RS-232C) (NT20-ST128)

[ PT SETTING ]

Data Bits            8 bits

Stop Bits            1 bit

Parity Check        Even

Flow Control        RS/CS

Baud Rate            19200 bps

EXIT

- The current PT settings will be displayed.
- Pressing the "EXIT" touch switch will exit the PT settings display, and the NT20 will return to the RUN Mode.



### 3-9-3 Checking the NT20 DIP Switch Settings

Display the NT20 DIP switch settings by using the menu operation from the System Menu as described below.

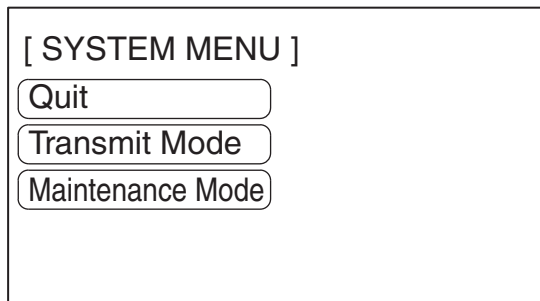

Select "Maintenance Mode".

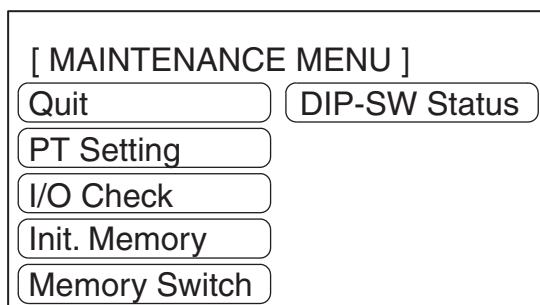

Select "DIP-SW Status".

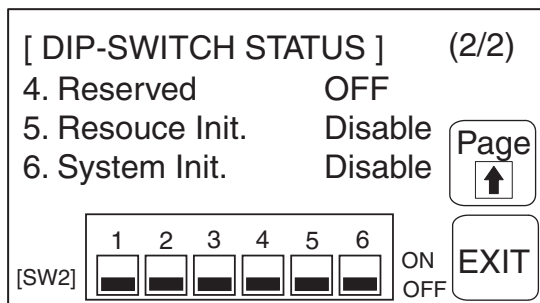
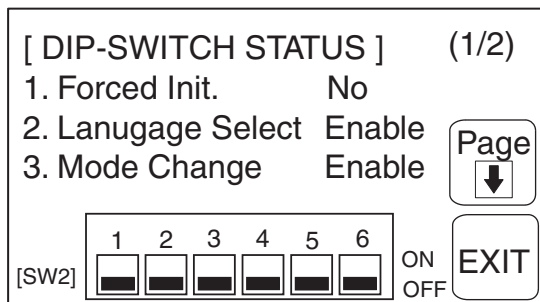

- The NT20 DIP switch status is displayed.
- Pressing the EXIT touch switch clears the DIP switch status display from the screen and causes the NT20 to enter the RUN mode.

**Note** If the DIP switch settings have been changed when the NT20 is powered, reset the power to the NT20. The changes with the DIP switches become effective only after the power supply is reset.

### 3-10 Transferring the System Program

The system program of the NT20 can be changed by the System Transfer Tool.

The system transfer tool is automatically installed in the personal computer when the NT20 support tool is installed.

For details on how to start up the System Transfer Tool, and the system transfer tool operation, refer to the *NT-series Support Tool Operation Manual* (V061-E1-□).

**Note** An NT20 which has no system program registered in it will be able to execute only the installation function.

For details on System Transfer Tool operations, refer to the *NT-series Support Tool Operation Manual* (V061-E1-□).

#### Transferring the System Program from the System Transfer Tool

In order to transfer the system program from the System Transfer Tool, first connect the NT20 to a personal computer running the System Transfer Tool using the appropriate cable, then proceed as follows.

**Reference** The NT20 uses the same connector (Port A) for connection to the Support Tool and connection to the host. If this connector is currently connected to the host, disconnect the cable from the host and connect it to the Support Tool (personal computer) before attempting to transfer the system program.

#### Operation

1. Connect the NT20 to the personal computer running the System Transfer Tool, then turn ON the power to the NT20.
2. Turn ON the power to the personal computer and start up the System Transfer Tool.
3. When the power to the NT20 is turned ON, the screen shown below will be displayed.

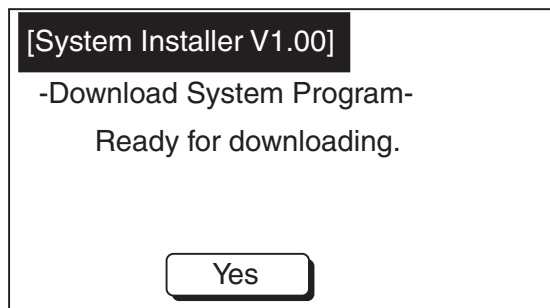

4. Press the **Yes** button to enter the system transfer mode, as shown below.

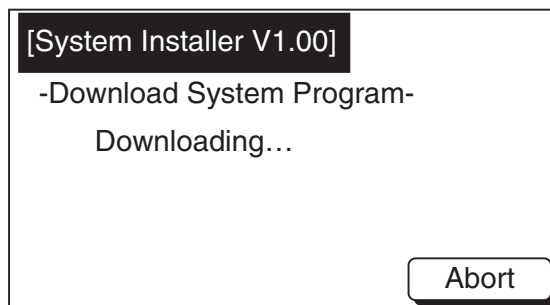

5. The NT20 is now on standby for reception. Start transfer of the program by using the System Transfer Tool. When the NT20 starts reception, the screen shown below will be displayed.

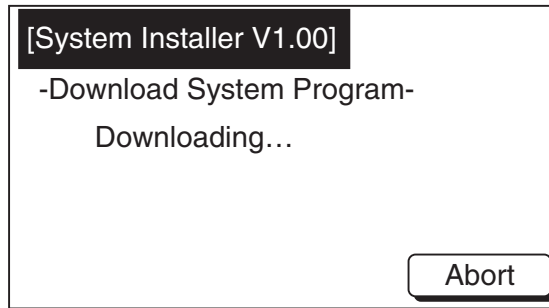

- When transfer of the system program has been completed, the NT20 will display the screen shown below.

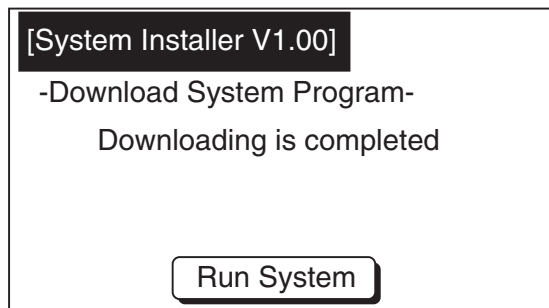

- Press the **Run system** Button when using the system transfer tool to return to run mode.

**Points to Observe during Transfer of the System Program**

If any of the following events or a system error occurs during transfer of the system program, the program will not be installed in the NT20 correctly.

- The power to the NT20 is turned OFF, or the NT20 is reset during transfer.
- The power to the personal computer that is running the System Transfer Tool is turned OFF, or the personal computer is reset, during transfer.
- The cable connecting the personal computer running the System Transfer Tool and the NT20 becomes disconnected or sustains a wire breakage during transfer.
- Transfer is terminated by pressing the **Abort** Button on the NT20.
- Transfer is terminated by pressing the ESC key of the personal computer running the System Transfer Tool.

In the event of any of the above, there is a possibility that the NT20 will not operate or that unpredictable malfunctions will occur.

To prevent this, turn ON DIP switch SW2-6 to erase the system program after the problem has occurred. For details on erasing the system program with the DIP switch, refer to *Method for Erasing the System Program* (page 127).

**Method for Erasing the System Program**

In order to erase the system program, the system program area must be cleared.

If a system program already exists, it must be erased before the new one can be transferred.

Use the following procedure to erase the system program.

**Operation**

- Set DIP SW2-6 to the ON position and turn ON the power or reset. The following screen will be displayed.

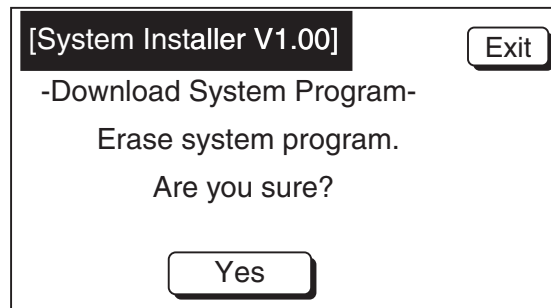

2. Press the Exit key if you want to quit without erasing the program. If you do want to erase the program, press **Yes** Button. This will start erasure of the program.  
During erasure, the screen shown below will be displayed:

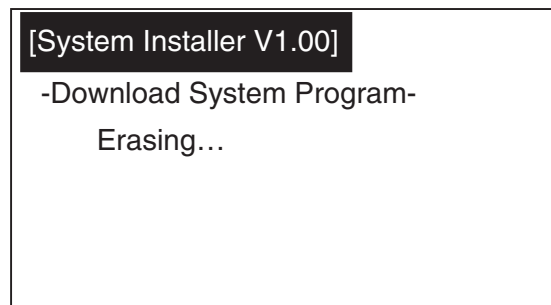

3. On completion of erasure, the screen shown below will be displayed. At this point, set DIP SW2-6 to the OFF position and reset the NT20.

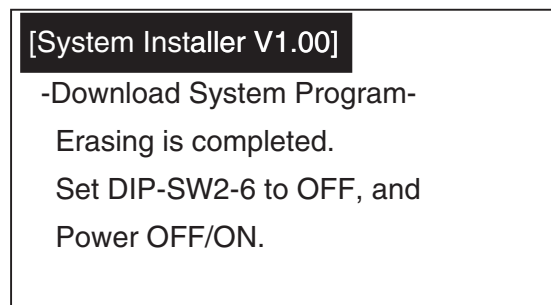

### 3-11 Transferring the Resource Data

The resource data of the NT20 can be changed using the System Transfer Tool.

The System Transfer Tool is automatically installed in the personal computer when the NT20 Support Tool is installed.

For details on how to start up the System Transfer Tool, and the System Transfer Tool operation, refer to the *NT-series Support Tool Operation Manual* (V061-E1-□).

**Note** An NT20 which has no resource data registered in it will display a resource error screen.

For details on System Transfer Tool operations, refer to the *NT-series Support Tool Operation Manual* (V061-E1-□).

#### Transferring the Resource Data from the System Transfer Tool

In order to transfer the resource data from the System Transfer Tool, first connect the NT20 to a personal computer running the System Transfer Tool using the appropriate cable, then proceed as follows.

**Reference** The NT20 uses the same connector (Port A) for connection to the Support Tool and connection to the host. If this connector is currently connected to the host, disconnect the cable from the host and connect it to the Support Tool (personal computer) before attempting to transfer the resource data.

#### Operation

1. Connect the NT20 to the personal computer running the System Transfer Tool, then turn ON the power to the NT20.
2. Turn ON the power to the personal computer and start up the System Transfer Tool.
3. When the power to the NT20 is turned ON, the screen shown below will be displayed.

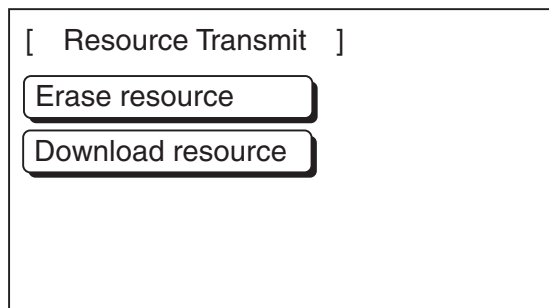

4. Press the **Download resource** Button to enter the resource transfer mode, as shown below.

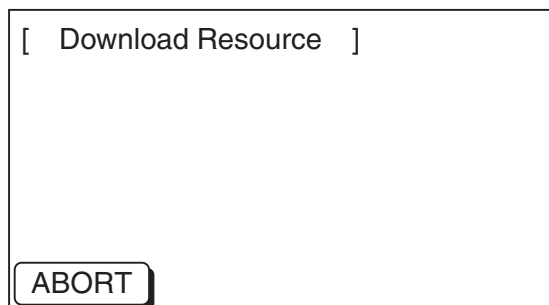

5. The NT20 is now on standby for reception. Start transfer of the program using the System Transfer Tool.

When the NT20 starts reception, the screen shown below will be displayed.

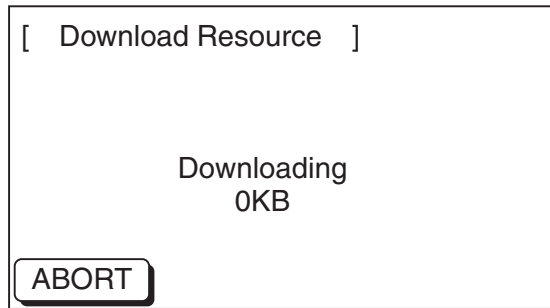

- When transfer of the system program has completed, the NT20 will display the screen shown below.

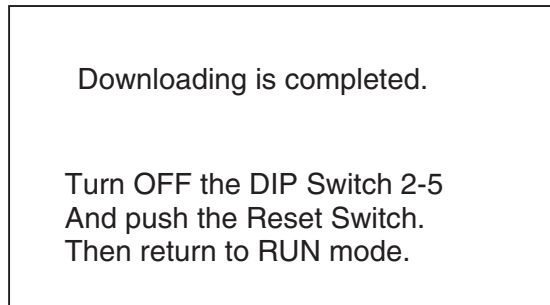

**Points to Observe during Transfer of the Resource Data**

If any of the following events or a system error occurs during transfer of the resource data, the program will not be installed in the NT20 correctly.

- The power to the NT20 is turned OFF or the NT20 is reset during transfer.
- The power to the personal computer that is running the System Transfer Tool is turned OFF or the personal computer is reset during transfer.
- The cable connecting the personal computer running the System Transfer Tool and the NT20 becomes disconnected or sustains a wire breakage during transfer.
- Transfer is terminated by pressing the **ABORT** Button on the NT20.
- Transfer is terminated by pressing the ESC key of the personal computer running the System Transfer Tool.

In the event of any of the above, a resource error will occur.

To prevent this, turn ON DIP switch SW2-5 to erase the resource data after the problem has occurred. For details on erasing the resource data with the DIP switch, refer to *Method for Erasing the Resource Data*.

**Method for Erasing the Resource Data**

In order to erase the resource data, the resource data area must be cleared. If resource data already exists, it must be erased before the new data can be transferred.

Use the following procedure to erase the resource data.

**Operation**

- Set DIP SW2-5 to the ON position and turn ON the power or reset. The following screen will be displayed.

[ Resource Transmit ]

Erase resource

Download resource

2. If you do want to erase the resource data, press the **Erase resource** Button. The following screen will be displayed.

Erase resource?

Yes

No

3. Press the **No** Button if you want to quit without erasing the resource data. If you do want to erase the resource data, press the **Yes** Button. This will start erasure of the resource data.

During erasure, the screen shown below is displayed:

Erase resource?

Yes Erasing

No

4. On completion of erasure, the screen shown below will be displayed.

[ Resource Transmit ]

Erase resource

Download resource





# SECTION 4

## NT20 Functions and Operation

This section describes the functions of the NT20.

4-1	Screen Creation Procedure .....	134
4-2	Outline of Functions .....	136
4-2-1	NT20 Screen .....	136
4-2-2	Characters and Figures Which Can Be Displayed .....	137
4-2-3	Communications with the Host .....	138
4-3	Screen Display .....	140
4-3-1	Classification of Screens .....	140
4-3-2	Screen Attributes .....	142
4-4	Memory Tables .....	144
4-4-1	Character-String Memory Table .....	144
4-4-2	Numeral Memory Table .....	145
4-5	Bar Graphs .....	147
4-5-1	Bar Graph Functions .....	147
4-6	Lamps .....	150
4-6-1	Lamp Functions .....	150
4-7	Touch Switches .....	152
4-7-1	Functions of Touch Switches .....	153
4-7-2	Screen Switching Function .....	154
4-7-3	System Key Functions .....	154
4-8	Numeral Setting .....	156
4-8-1	The Numeral Setting Function .....	156
4-8-2	Types of Numeral Setting .....	157
4-8-3	Creating Numeric Keys .....	158
4-8-4	Using Numeric Keys .....	160
4-8-5	Using The Thumbwheel Type of Numeral Setting .....	161
4-8-6	Settings for Numeral Settings .....	162

# 4-1 Screen Creation Procedure

Follow the procedure shown below to create screens for the NT20.

The following gives the procedure assuming that the setting for the PT has been completed. The operating procedure for the Support Tool is not given here. For the operating procedure for the Support Tool, refer to the *NT-series Support Tool Version 4.8 for Windows Operation Manual* (Cat. No. V061-E1-□).

### Creating a New Screen

#### Tool Setting (PT model)

Set the PT model as follows:

NT20: Set NT20.  
NT20S: Set NT20S.

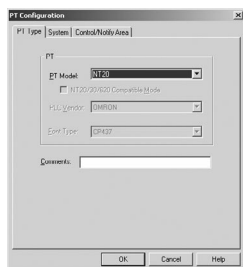

#### System Setting (Memory Switch Setting)

Set the memory switches that determine the basic operation of the PT. The numeral/character string/bit memory table entry settings should also be made at this stage.

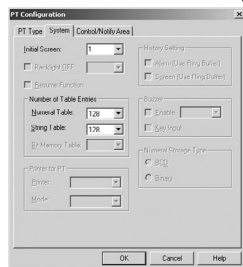

#### Setting for PT Status Control/Notify Area

Allocate words for the PT status control area and PT status notify area, necessary for the direct connection function, in the host.

For details, refer to 5-1-3 *NT20 Status Control and Notification to PLC*.

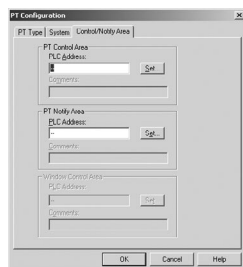

### Correcting an Existing File

#### File Designation

Designate a work file.

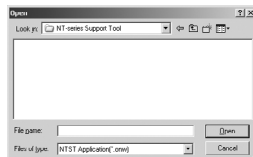

### Importing DOS Version Data

#### File Designation

Designate the work file to be data converted.

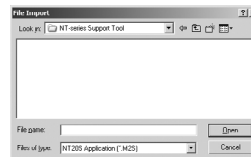



Creating and Correcting a Screen

After designating a screen, set the screen properties and register elements for the screen or correct the screen. If necessary, create marks, image data, and library data, and set the initial values of memory table entries. For details of screens and elements, refer to *SECTION 4 NT20 Functions*.

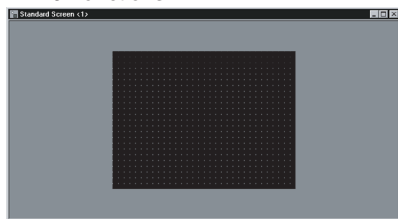

Saving a File

Save the created screen data to a file.



Transmitting the Screen Data

Transmit the created screen data to the PT. After setting the PT in the Transmit mode, execute the screen data transmission operation with the Support Tool.

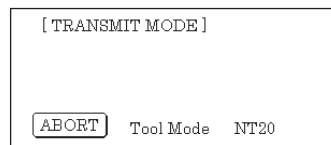

Support Tool

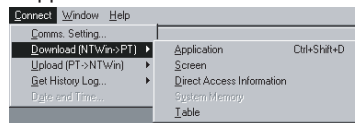

**Caution** Carefully check the operation of all screen data and host programs before using them. Otherwise the system may operate unpredictably.

## 4-2 Outline of Functions

### 4-2-1 NT20 Screen

This section gives the outline of the screen which is the basis of all NT20 functions.

For specific operation procedure such as screen switching, refer to *5-1-4 Switching the Screen Display* (page 172).

#### Composition of the Screen

The NT20 screen is composed of horizontal 256 dots x vertical 128 dots. Each dot is set by the combination of the X (horizontal) and Y (vertical) coordinates. The origin of coordinates (0, 0) is set at the top left corner of the screen.

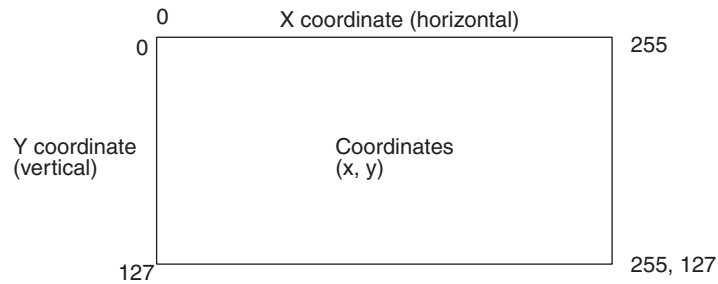

#### Screen Management

The screens displayed on the NT20 are managed by the screen numbers.

When using the NT20, up to 495 screens can be created and screen numbers in the ranges 1 to 250 and 256 to 500 can be used (numbers 251 to 255 are reserved for system use).

The display screens can be switched or the start-up screen can be set by designating the screen number from the Host.

#### Special Screen Number

Screen number "0" is reserved for the system as the no-display screen. Select this to display nothing on the NT20 screen.

### 4-2-2 Characters and Figures Which Can Be Displayed

The NT20 screen can display characters, figures, and other various elements. This section describes the types and attributes of the characters and figures which can be displayed and do not need to be changed at all.

For the settings, display, and use of the characters, numeric values, and graphs which change according to the system operation status and other conditions, refer to *4-4 Memory Tables* (page 144).

The power of expression of the screen can be increased by giving various attributes such as the enlarged or reverse display to the characters and figures.

The character and figure attributes can be set in the edit screen when creating the screen data by using the Support Tool.

When using the NT20-ST128 (RS-232C), character strings can also be displayed according to commands from the host, independently of the currently displayed screen (this is the “terminal function”).

#### Types and Attributes of Characters and Figures

The following types of characters can be input by using the Support Tool and be displayed during operation.

Character Type	Dots (vertical x horizontal)	Character Set	Maximum Number of Characters Displayed in One Screen (without overwriting)
Half height characters	8 x 8	Alphanumerics and symbols	32 characters x 16 lines (512 characters)
Normal characters	16 x 8	Alphanumerics and symbols	32 characters x 8 lines (256 characters)
	16 x 16	GB2312	16 characters x 8 lines (128 characters)
Marks	16 x 16	Create by using the Support Tool	

- Marks

A mark is a graphic pattern created by combining 16 x 16 dots by using the Support Tool. Marks can be handled the same as the wide size characters. Up to 64 patterns can be defined within the total screen data using character code FF20 to FF5F.

- Enlarged Display of Characters and Marks

The characters and marks can be enlarged to the following scales.

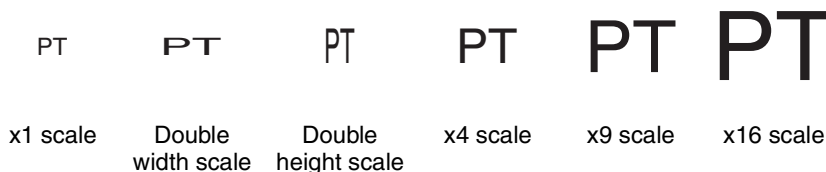

**Note** Smoothing

The characters and marks enlarged to the x4 scale or larger are displayed with the outline automatically smoothed. This function is called “smoothing”.

- Reverse and Flashing Display

Reverse display: The display brightness of the character and the background is reversed comparing with the normal display.

Flashing display: Characters are displayed as they flash. The normal display alternates with no-display.

Reverse and flashing display: The reverse display alternates with the normal display.

### Types and Attributes of the Figures

The following types of figures can be input by using the Support Tool and be displayed during operation. Continuous straight lines including up to 256 vertices can be drawn (up to 255 straight lines can be connected).

Continuous straight lines

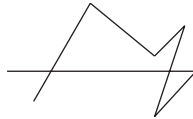

Circle



## 4-2-3 Communications with the Host

### Communications Using Host Link/NT Link/C200H Direct Communications

The NT20 can communicate with the PLC through the host link/NT link. Bits and words are allocated to areas of the PLC memory (selectable without restriction) and the NT20 can write data to them or read from them directly. This makes the following functions possible:

- Control/Notification of display elements
- Control/Notification of the NT20 status
- Screen switching
- Ascertaining the number of the screen currently displayed
- Memory table operations

For details on actual operations, refer to *SECTION 5 How to Use the Host Link/NT Link*.

### Communications through RS-232C

The NT20-ST128 can communicate with the host through the RS-232C interface. In other words, it can receive and send commands through the RS-232C interface, which allows various types of host to utilize the functions of the NT20:

- Control/notification of display elements
- Control/notification of the NT20 status
- Memory table operations
- Screen operation
- Display/deletion of characters/graphics

For details on actual operations, refer to *SECTION 6 Using RS-232C Communications*.

### Controllable NT20 Functions

The following NT20 status can be controlled:

- Screen switching: Screen is displayed or cleared.
- Continuous/intermittent buzzer: Buzzer operation is started or stopped.
- Back light mode: Back light is lit or made to flash.

For details on how these NT20 functions are actually controlled, refer to *5-4 NT20 Status Control* on page 203, and *Buzzer Control* on page 228.

**Ascertainable Operating Status of the NT20**

The following operating status of the NT20 can be ascertained:

- NT20 operating/stopped status: Whether the NT20 is active or inactive
- Screen number: Number of the screen currently displayed
- Numeral setting input: Whether or not numerical values have been input by numeral setting

For details on how these NT20 operating status is actually detected, refer to *5-5 Notification of the Operating Status to the PLC (Determining the NT20 Operating Status)* on page 208, *Screen Number Response* on page 217, and *Eight-digit Number Input Notify* on page 225.

 **Caution** To ensure system safety, be sure to periodically read the PT operating status bit from the host in order to ensure that the PT is always operating normally.



## 4-3 Screen Display

This section describes the screen information required for the operation with the NT20.

For details on how to change the displayed screen, refer to *5-1-4 Switching the Screen Display* on page 172, and *Display Specified Screen* on page 216. For the methods used to ascertain the screen number of the screen currently displayed, refer to *5-1-5 Notifying the PLC of the Display Screen (to Display the Number of Currently Displayed Screen)* on page 174, and *Request Screen Number* on page 216.

### 4-3-1 Classification of Screens

The NT20 is provided with the following types of screens which are classified by the display method.

- Normal screen
- Overlapping screen
- Continuous screen

The screen type is set with each screen in the “Screen List” screen of the Support Tool. Select a screen type according to the purpose, and create characters and figures on the screen.

#### Normal Screen

A normal screen is the basic screen of the NT20. It is not necessary to select a screen type (overlapping or consecutive) when to create the screen data on a normal screen.

When a normal screen is selected, existing screens will be erased and a normal screen will be displayed.

#### Overlapping Screen

Several normal screens can be overlapped and displayed as one screen. A group of overlapped screens is called an “overlapping screen”.

Several normal screens are displayed in the order of screen numbers which have been designated to each screen and form an overlapping screen. Up to eight screens can be overlapped to form one overlapping screen. The base screen used for making an overlapping screen is called a “parent screen”, and a bunch of screens which are laid over the parent screen are called “child screens”.

All display elements can be used on a parent screen.

The screen attributes such as a buzzer attribute set in the parent screen become effective in an overlapping screen.

#### Example Overlapping Screens

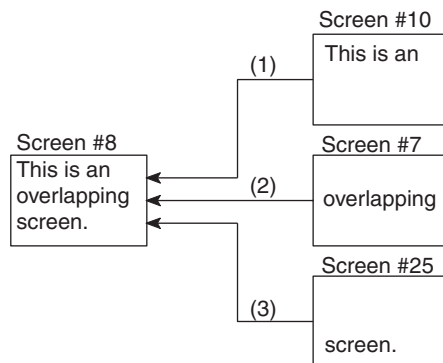

- Parent screen: #8
- Child screens: #10, #7, and #25

When screen #8 is designated, screen #8 becomes the parent screen and the child screens #10, #7, and #25 are displayed over the parent screen in that order.

Only one numeral setting screen which allows numeric values to be set on the NT20 screen can be registered as a child screen. For the numeral setting, refer to *4-8 Numeral Setting* (page 156).

Make sure that the touch switches and numbers set in the normal screens do not overlap in an overlapping screen. If the set positions of the touch switches and/or numbers in the normal screens overlap with each other, such settings may sometimes not be effective as intended. Use the Support Tool and make sure that the set positions do not overlap with each other.

**Continuous Screens**

A group of normal screens which are related in series and can be switched consecutively is called the “continuous screens”. Up to eight screens can be registered to one screen as a group of continuous screens.

The base screen used for registering the continuous screens is called a “parent screen”, and the registered continuous screens are called “child screens”. The current screen number and the total number of continuous screens can be displayed in the top right corner of the screen. This is called the “page number display”.

The page number is set when creating the screen data by using the Support Tool. Refer to the “NT-series Support Tool for Windows Operation Manual” (Cat. No. V061-E1-□).

All display elements except “numeral setting” can be used in the continuous screens.

The screen attributes set in the parent screen become effective in the continuous screens.

**Example Continuous Screens**

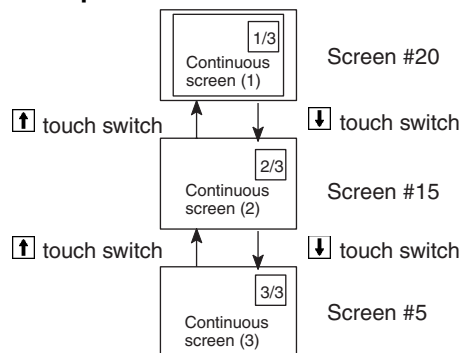

- Parent screen: #10
- Child screens: #20, #15, and #5

When screen #10 (continuous screen) is designated, screen #20 which is page 1 of the continuous screens will be displayed. Screen #15 or #5 can be displayed by using the touch switches. Since screen #10 has been set for the continuous screens, that screen cannot be displayed as an individual screen.

**Switching Continuous Screens Using Touch Switches**

Continuous screens can be switched by using the [↓] and [↑] touch switches which have the system key functions.

When creating the screen, create touch switches [↓] and [↑] to which the system key functions are allocated. (Refer to *4-7-3 System Key Functions* on page 154.)

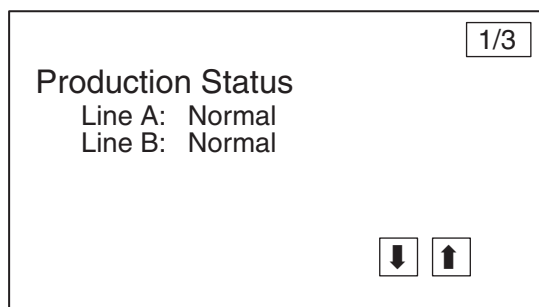

## 4-3-2 Screen Attributes

Each screen can be set with a specific function by designating a screen attribute, so that the specific function can be executed by displaying the screen. For example, by displaying a screen to which a “buzzer attribute” has been set, the buzzer of the NT20 starts sounding.

Set the screen attributes for each screen on the “screen selection” screen of the Support Tool.

Note that the Support Tool displays some items that are not used with the NT20.

The following several attributes can be set with one screen.

### Buzzer Attribute

This attribute will become effective to sound the buzzer in the NT20 when the screen to which this attribute has been set is displayed. The buzzer sound can be set as follows:

No: Buzzer does not sound when the screen is displayed.

Continuous sound: Buzzer sounds continuously.

Intermittent sound: Buzzer sounds intermittently at constant intervals.

The buzzer sound is set with the NT20 memory switch. The buzzer can also be set by using the Host. Refer to *3-8-2 Using the Buzzer* on page 107 for the buzzer setting using the memory switch.



To stop the buzzer by using the screen operation, create a  system key as a touch switch.

### Numeral Setting Attribute

Select whether the numeric keys are automatically displayed or the numeric keys are created at arbitrary positions on the numeral setting screen. The following two numeral setting attributes are used.

System: The numeric keys registered to the system are automatically displayed.

User: The numeric keys can be created at any arbitrary positions.

**Note** If the numeral setting attribute on the NT20 has been set for “system”, the touch switches [ENT],  and  which are allocated to the system besides the numeric keys need to be created. (Refer to *4-7-3 System Key Functions* on page 154.)

### Bit Input Attributes (NT20-ST128 Only)

Select whether the host is notified of the touch switch number or bit information when the touch switch is pressed. There are two types of bit input attribute in the screen attributes, as described below:

- Off: Bit control when a touch switch is pressed is invalid. Notification of the status of the touch switch is provided using its number.

- Touch SW:Bit control when a touch switch is pressed is valid. Notification of the status of the touch switch is provided using bit information.

**Backlight Attributes**

Select whether the backlight is lit or flashes when the screen is displayed. There are two types of backlight attribute in the screen attributes, as indicated below:

- Lit: Backlight is lit when the screen is displayed.
- Flashing: Backlight flashes when the screen is displayed.

## 4-4 Memory Tables

The NT20 has the “character-string memory table” for the character data and the “numeral memory table” for numeric data which can be written and updated by the PLC/Host.

The contents of the memory table entries can be set by using the Support Tool when displaying the memory table entries on the screen or by editing the table.

### 4-4-1 Character-String Memory Table

The character-string memory table is an NT20 internal memory used to store the character data. Up to 128 character-string memory table entries can be used, and up to 16 full size characters (32 bytes) can be stored in one memory table entry. The character-string memory table entries at up to 32 positions can be registered in one screen.

#### Displaying a Character String

The character-string memory table entries are registered with table entry numbers 0 to 127.

When creating the screen data by using the Support Tool, set the position on the screen to display a character string and also set a character string number to be displayed.

When the NT20 is operated, the screen displays the contents of the character-string memory table.

When using a direct connection, it is possible to display the contents of character-string memory table entries by specifying their numbers with numeral memory table entries (indirect specification), rather than directly changing the character-string memory table contents.

For details on how to change currently displayed character strings, refer to *5-2-2 Changing Displayed Numerals or Character Strings (Changing the Contents of Allocated Words ... Direct Specification)* on page 182, and *Write Character-string Memory Table* on page 218.

When using the NT20-ST128 (RS-232C), character strings can be also displayed according to commands from the host, independently of the currently displayed screen (terminals Function). Refer to *Specify Displayed Characters* on page 232.

#### Characters and Figures Which Can Be Displayed

The power of expression of the screen can be increased by giving various attributes such as the enlarged or reverse display to the characters of the character-string memory table.

The character attributes can be set in the edit screen when creating the screen data by using the Support Tool.

The following types of characters can be displayed on the NT20:

Character Type	Dots (vertical x horizontal)	Character Set	Maximum Number of Characters Displayed in One Screen (without overwriting)
Half size characters	8 x 8	Alphanumerics and symbols	32 characters x 16 lines (512 characters)

Normal size characters	8 x 16	Alphanumerics and symbols	32 characters x 8 lines (256 characters)
	16 x 16	GB2312	16 characters x 8 lines (128 characters)
Marks	16 x 16	Create by using the Support Tool	

- Enlarged Display of Characters and Marks  
The characters and marks can be enlarged to the following scales.  
Double width scale, Double height scale, x4 scale, x9 scale, x16 scale
- Smoothing  
The characters and marks enlarged to the x4 scale or larger are displayed with the outline automatically smoothed. This function is called “smoothing”.
- Reverse and Flashing Display  
Reverse display: The display brightness of the character and the background is reversed comparing with the normal display.  
Flashing display: Characters are displayed as they flash. The normal display alternates with no-display.  
Reverse and flashing display: The reverse display alternates with the normal display.

## 4-4-2 Numeral Memory Table

The numeral memory table is an NT20 internal memory used to store the numeral data. Up to 128 numeral memory table entries can be used, and up to eight digits (four bytes) of numeral data (including signs) can be stored in one numeral memory table entry. The numeral memory table entries at up to 50 positions can be registered in one screen.

### Displaying a Numeral

The numeral memory table entries are registered with table entry numbers 0 to 127.

When creating the screen data by using the Support Tool, set the position on the screen to display a numeral and also set a numeral number to be displayed.

When the NT20 is operated, the screen displays the contents of the numeral memory table.

- ➔ For details on how to change the currently displayed numeric data, refer to *5-2-2 Changing Displayed Numerals or Character Strings (Changing the Contents of Allocated Words ... Direct Specification)* on page 182, and *Four-digit Write Numeral Memory Table* on page 219.

### Numerals Which Can Be Displayed

The power of expression of the screen can be increased by giving various attributes such as the enlarged or reverse display to the numerals of the numeral memory table.

The numeral attributes can be set in the edit screen when creating the screen data by using the Support Tool.

- Digits of the whole numbers: 1 to 8 digits
- Digits of the decimal fraction: 0 to 7 digits
- Character sizes: Half, normal
- Enlarged display: Double width, double height, x4, x9, x16

The characters enlarged to the x4 scale or larger are displayed with the outline automatically smoothed. This function is called "smoothing".

- Display attribute: Normal, reverse, flashing, reverse and flashing
- Sign display setting
- Decimal/hexadecimal display setting
- Zero suppress setting

To display one numeral memory table entry on several different screens simultaneously, the display attributes on such screens must be the same. If there are discrepancies among the display attributes, the numeral table entry may not be displayed correctly.

**Note** Zero Suppress Setting

The numeral data are displayed in designated display areas as right-aligned. If the number of digits of a numeral data is smaller than that of the display area, number "0"s will be displayed at the vacant digits. These "0"s will not be displayed if the zero suppress setting is made for "Yes".

## 4-5 Bar Graphs

The contents of the numeral memory table entries of the NT20 can be displayed as bar graphs as well as numeral data.

This section describes the bar graphs which can be displayed.

In order to change the data displayed in a bar graph, the contents of its numeral memory table entries have to be changed.

For details on how to update the data of a currently displayed bar graph, refer to *5-2-5 Upgrading Bar Graphs (Changing the Contents of Allocated Words)* on page 189, and *Four-digit Write Numeral Memory Table* on page 219.

### 4-5-1 Bar Graph Functions

The bar graph function displays a value in a bar graph form as a percentage to the specified value according to the contents of a numeral memory table entry. Up to 50 bar graphs can be registered in one screen.

- Reference Table Entries

The numeral memory table entries used as the reference for the bar graph display can be set.

The Support Tool has the “direct” and “indirect” options for the reference method of the numeral memory table. However, the NT20 recognizes the “direct” method only.

The bar graph display cannot use hexadecimal numbers. If hexadecimal numbers are set in the reference numeral memory table entries, the bar graph cannot be displayed. Use caution not to write hexadecimal numbers except the minus sign “F” to the reference numeral memory table entries.

#### Bar Graph Attributes

The following attributes can be set with the NT20 for the bar graph display:

- Position and Size

The display position and size (length) of a bar graph can be set.

The width of the bar graph can be set in the range of 2 to 255 dots.

- Orientation and Incremental Direction

The orientation and incremental direction of the bar graph can be selected from those described below.

↑ (up): The bar graph increments upward in the vertical orientation.

↓ (down): The bar graph increments downward in the vertical orientation.

← (left): The bar graph increments to the left in the horizontal orientation.

→ (right): The bar graph increments to the right in the horizontal orientation.

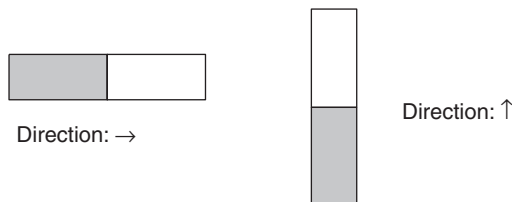

- Graph Frame

Select whether or not the graph frame (boundary line of a graph display area) which indicates the effective display range is displayed.



- Setting the 100 % Value and % Display



Set a value which corresponds to 100 % for the “100 % value”. The available value range is “0 to 99999999” (eight digits max.). For the “% display”, whether or not the proportion (percentage) of the reference numeral memory table value to the “100 % value” is displayed in a numeral can be selected. The display value is calculated as follows:

$$\text{“% display” value} = \text{Numeral memory table value} \div \text{“100 % value”} \times 100$$

For the font and attributes used for the numeral display, refer to *Numerals Which Can Be Displayed* on page 145.

- Sign Display and Display Method

Select whether or not the bar graph which indicates a value below 0 % is displayed.

**To Display Values Below 0 %: Sign Display “Yes”**

The bar graph is displayed in the range of -100% to 100%. The middle of the bar graph indicates 0%.

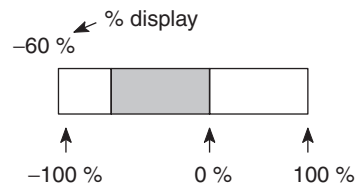

**To Not Display Values Below 0 %: Sign Display “No”**

The bar graph is displayed in the range of 0% to 100%. The end of the bar graph indicates 0%. Values below 0% are indicated as 0%.

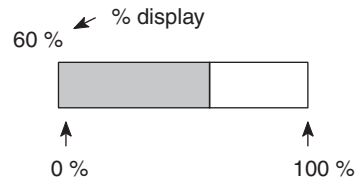

- Differences in the Bar Graph Display Method According to the % Values

The bar graph display method varies according to the % value range.

1. When the % value is in the minus range

The display varies as follows according to the sign display setting:

Sign display “No”: Displayed as 0%.

Sign display “Yes”: Displayed in the minus range.

2. When the absolute value of the % value is in the range of 100% to 999%

The % value is displayed as it is.

Sign display “No”: The display will be as shown below according to the graph frame setting.

When the frame is displayed:

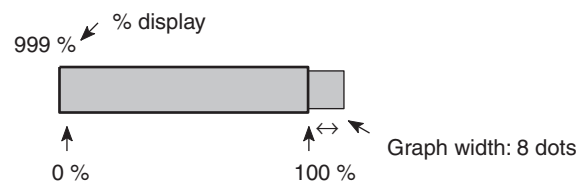

When the frame is not displayed:

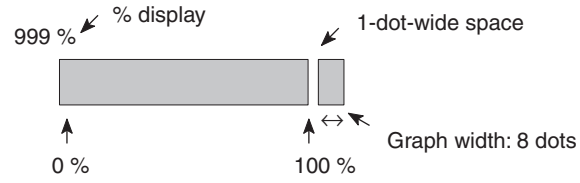

Sign display “Yes”: A value below  $-100\%$  will be displayed in the minus direction as shown above.

- 3. When the absolute value of the % value is above 1000%

The bar graph will be displayed the same as (2) above.

The % value is displayed as follows according to the sign display setting:

Sign display “No”:\*\*\* %

Sign display “Yes”:\*\*\*\* %

## 4-6 Lamps

The NT20 has the “lamp” function used to simply display the PLC bit status. This section describes the lamps which can be displayed. The lamp display status (lit (flashing) or unlit) can be changed by instructions from the PLC/host.

For details on how to change the status of a currently displayed lamp, refer to *5-3-2 Turning ON (Lit) and OFF (Unlit) the Lamps (Changing the Contents of Allocated Bits)* on page 192, *Lamp and Touch Switch Display (Bit Specification)* on page 223, and *Lamp and Touch Switch Display (Number Specification)* on page 223.

### 4-6-1 Lamp Functions

The lamps are the graphic areas whose method of display can be changed by using the PLC. Available display methods are “lit”, “unlit”, and “flash”. Up to 128 lamps can be registered in one screen.

The display status (lit, unlit, and flashing) which are registered when creating the screen data can be switched according to the ON/OFF of the PLC bit status.

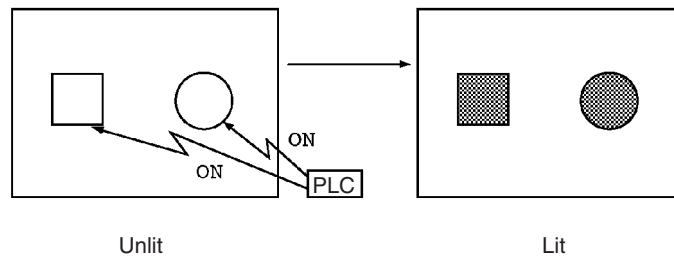

#### Lamp Attributes

The following attributes can be set with the lamp. Use the Support Tool to set the lamp attributes.

- Shape

Select from the square and circle shapes. The display size can be freely selected.

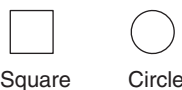

- Frame

Select whether or not the boundary line (frame) of the lamp display area is displayed. If the frame is not set, only the guide display message for the lamp is displayed when the lamp is not lit (or flashing). If the guide display message is not set, nothing is displayed.

- Lit and Flashing

Select whether the lamp is lit (reverse display) or flashing (reverse flashing) when the lamp is turned ON by the PLC.

- Guide Display Message

Lamps can be displayed with the guide display messages.

The guide display message attributes are the same as that for the “character display”. Refer to *Characters and Figures Which Can Be Displayed* on page 144.

- Frame and Lit/Flashing

The display method of “lit/flashing” varies according to the frame setting.

Frame is set: Only the area in the frame will be lit/flashing.  
 Frame is not set: The area including the frame will be lit/flashing.

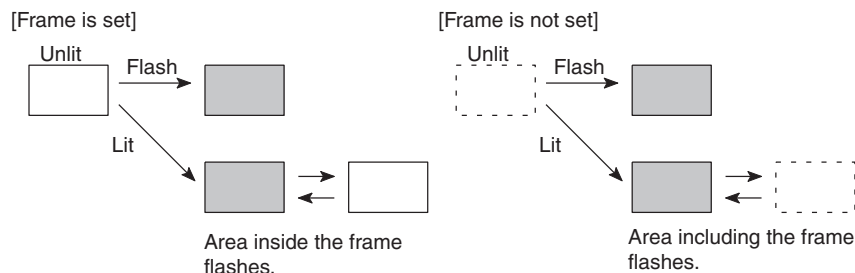

• Controlling the Lamps in Batch

More than one lamp can be lit or flashing in batch by registering those lamps to the same bit.

**Example of Batch Lighting**

Set the lamps L1 to L5 to the same bit number.

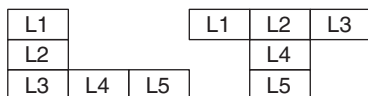

**When a Lamp Is Overlapped with a Memory Table Display**

The guide display message for a lamp is a fixed character-string. If you want to change the lamp guide display according to some condition, overlap the display area of a numeral memory table entry or character-string memory table entry with the lamp. However, note that different results will be achieved depending on the timing of the lighting of the lamp and the updating of the memory table entry. Bear this in mind when creating the control program.

**Example 1 Lighting a Lamp after Changing a Memory Table Entry**

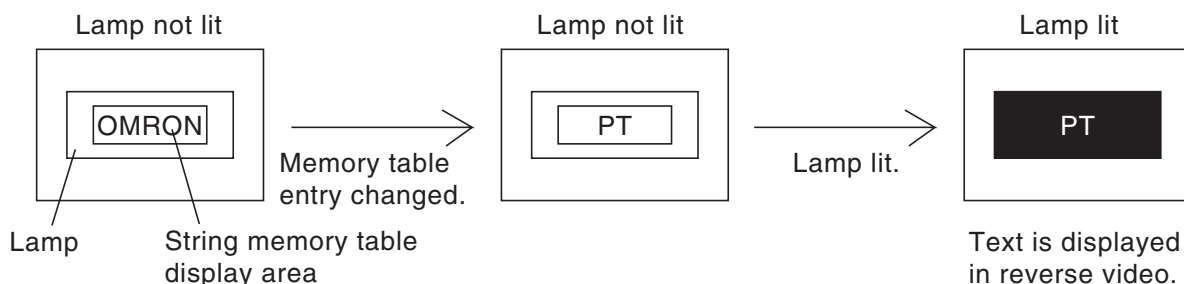

**Example 2 Changing a Memory Table Enter while the Lamp Is Lit**

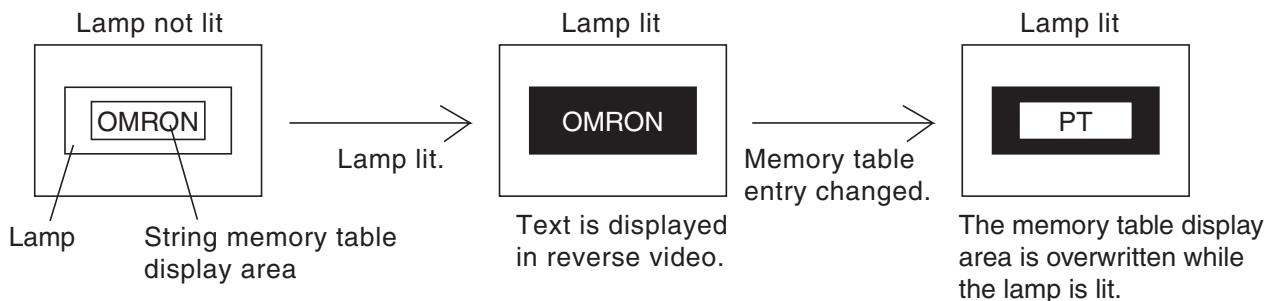

## 4-7 Touch Switches

The NT20 has a function whereby input operations can be performed by using touch panels displayed on the screen. NT20 screens can be switched, or bit information sent to the Host, by pressing (lightly touching) the “touch switches” in a panel.

The touch switches can also be made to light up (or flash) and go off like lamps.

Touch switches are set when creating the screen data with the Support Tool.

This section describes the touch switches that can be displayed, and explains the screen switching function and the system key function.

For details on how the status of the currently displayed touch switch is sent to the Host, refer to *5-3-4 Lit (Flashing) and Unlit Touch Switch Status (Changing the Status of Allocated Bits)* on page 195, *Lamp and Touch Switch Display (Bit Specification)* on page 223, and *Lamp and Touch Switch Display (Number Specification)* on page 223.

For details on how the status of touch switches is ascertained by the Host, refer to *5-3-5 Notifying the Host That a Switch Has Been Pressed (Determining Touch Switch Status)* on page 196, and *Lamp and Touch Switch Display Status Enquiry* on page 224.

**⚠ Caution** Do not use input functions such as PT touch switches for applications where danger to human life or serious property damage is possible or for emergency switch applications.

**⚠ Caution** Press touch switches with a force of no greater than 30 N.

**⚠ Caution** Do not press touch switches carelessly while the backlight is off or while nothing is displayed on the screen. Otherwise the system may operate unpredictably.  
Only press touch switches after confirming system safety.

**⚠ Caution** If touch switches are pressed in rapid succession, their inputs may not be successfully received.  
Confirm that the input of a touch switch has been successfully received before moving on to the next operation.

### Note

Caution on pressing touch switches at 3 points  
When multiple touch switches are created at the relative positions indicated in the example below, malfunctions may occur due to the characteristics of this switch configuration.

Example 1: When switches are created at positions A and B and at the points where the vertical and horizontal lines extending from these two points intersect, i.e. points C and D:

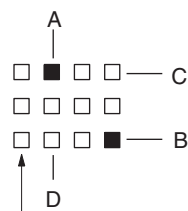

Smallest touch switch frame

- When switches A, B, and C are switched on at the same time, switch D is also assumed to have been switched on due to the configuration of the touch switches.

- When switches A, B, and D are switched on at the same time, switch C is also assumed to have been switched on due to the configuration of the touch switches.

### 4-7-1 Functions of Touch Switches

Touch switches are created using rectangular elements measuring 19 dots horizontally by 19 dots vertically. A touch switch can comprise more than one touch switch element. Up to 72 touch switches (12 horizontally x 6 vertically) can be registered on one screen.

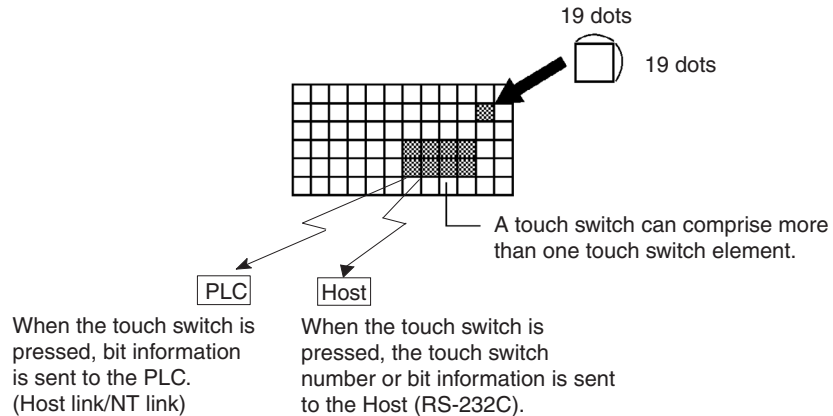

- **Functions of Touch Switches**

Touch switches can have the following functions:

- **PLC notification function:**  
 Host link/NT link/C200H direct communications (page 196)  
 RS-232C (NT20-ST128) (page 224)
- **Screen switch function** (page 154)
- **System key function** (page 154)
- **Numeral setting function:**  
 Host link/NT link/C200H direct communications (page 199)  
 RS-232C (NT20-ST128) (page 224)

#### Touch Switch Attributes

The following attributes can be set for touch switches.

- **Display Frame**

The area that will respond as a touch switch is displayed in the form of a frame, as shown in the table below. One of three types of frame - standard, 3-D, and none - can be selected.

Type of Display Frame	Switch OFF	Switch ON
Standard		
3-D		
None		

If “none” is selected, only the touch switch’s guide display message (or nothing, if there is none) are displayed until a “light” or “flash” designation is sent from the PLC/Host or the touch switch is pressed.

- **Inverse Display on Input**

It is possible to set a touch switch so that its display will be inverted when it is pressed.

- **Lighting and Flashing**

It is possible to specify whether the touch switch will be lit continuously or flash when the bit allocated to it is turned ON by the PLC/Host.

- Presence/Absence of a Guide Display

A guide display message can be displayed at a touch switch location.

### 4-7-2 Screen Switching Function

The NT20 has a function that allows screens to be switched by pressing touch switches on its screen, rather than by designation from the PLC/Host. This function is called the “standalone function”.

The screen number of the screen that will be displayed when a touch switch is pressed is set for that touch switch when the screen data is created using the Support Tool.

If the touch switch is pressed during operation, the screen whose number was designated will be displayed. Simultaneously, the PLC/Host will be notified of the screen number of the screen selected for display.

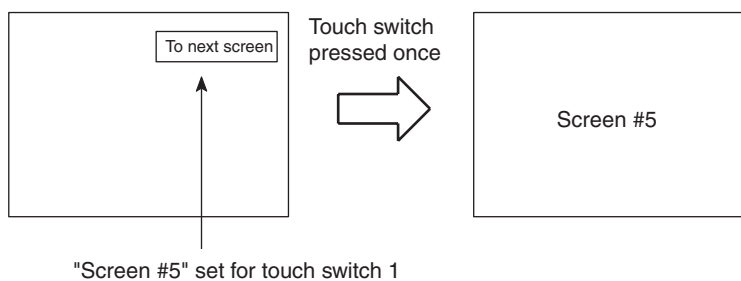

To set a screen number for a touch switch, use “Touch SW”, “Bit specification” and “Screen switch” of the Support Tool.

**Note** Only one screen number can be set for one touch switch within one screen (or within one overlapping screen).

### 4-7-3 System Key Functions

The NT20 allows the allocation of “system key” functions to touch switches. The system key functions can then be used during operation by pressing the touch switches to which they have been allocated.

For example, if, when a screen for which buzzer sounding has been set is displayed, a [Buzzer stop] touch switch is also displayed, the buzzer can be stopped by pressing this touch switch.



To set a system key function for a touch switch, use “Touch SW”, “Bit specification” and “Numeric key” of the Support Tool.



#### Allocation of System Key Functions

The system key functions are allocated to touch switch numbers 227 to 230 and 255, as shown below. When a touch switch with one of these numbers is displayed on the screen, it has the same function as the corresponding system key.

System Key	Key Symbol	Touch Switch No.
System menu display	MENU	227
↑	↑	228
↓	↓	229
[Buzzer stop]	[Buzzer stop]	230
[ENT]	[ENT]	255

- ➔ When a touch switch to which a system key function has been allocated is pressed, the PLC is not notified of the touch switch bit information.

The , , and  keys are not displayed among the system numeric keys.

Accordingly, when using the system numeric keys, create the , , and  keys. Alternatively, create user numeric keys.



## 4-8 Numeral Setting

The NT20 has a “numeral setting” function to enable numerical values to be input from the screen. This function inputs numerical values to numeral memory table entries in response to touch switch operations, displays these numerical values on the screen, and sends them to the host.

This section outlines the numeral setting function and the method for creating the ten keys required to set numerical values on the screen, and explains how to use ten keys during operation.

Numeral setting screens cannot be registered as child screens of continuous screens. In the case of overlapping screens, only one of the screens can be set as a numeral setting screen.

For details on the actual methods used to ascertain input numerical values at the PLC, refer to *5-3-6 Notification of Numbers to the PLC* on page 199, and *Four-digit Number Input Notify* and *Eight-digit Number Input Notify* on page 225.

Numeral settings are set during screen creation with the Support Tool.

**Caution** Confirm system safety carefully before changing monitor data.

### 4-8-1 The Numeral Setting Function

The numeral setting function is described below.

#### Basic Procedure

The procedure for numeral setting is as follows.

- 1,2,3...
1. Input the numerical value at the touch panel.
  2. The input numerical value is displayed in the numeral setting area on the screen.
  3. Confirm the input numerical value; it will be written to the numeral memory table, and the PLC will be simultaneously notified.

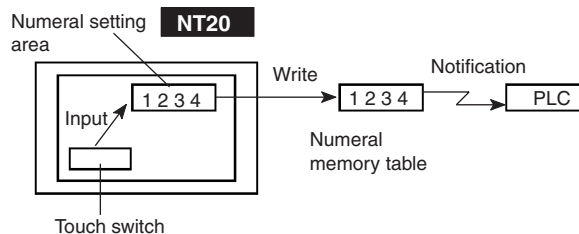

#### Restrictions on Numerical Value Input and Attribute Setting

Numerical values of up to 8 digits (7 if there is a minus sign) can be input in either decimal or hexadecimal format.

- Decimal Input

When the display attribute is set for decimal display, values are input in the decimal format.

- Numerical Value Range

The range for numerical values that can be input differs according to whether or not there is a sign display.

When there is no sign display: 0 to 99999999 (8 digits)

When there is a sign display: -9999999 to +99999999  
(7 digits for negative numbers, 8 digits for positive numbers)

If a sign is displayed when using the thumbwheel type of numeral setting, the maximum number of digits for both positive and negative numbers is 7.

- Decimal Point

A maximum of 7 digits can be input after the decimal point (or 6 for negative numbers).

- Hexadecimal Input

When the display attribute is set for hexadecimal display, values are input in the hexadecimal format.

- Numerical Value Range

Numerical values can be input in the range 0 to FFFFFFFF (8 digits).

- Attributes That Can Be Set

The attributes of the numerical values displayed in the input field are the same as for numeral displays. Refer to *Numerals Which Can Be Displayed* on page 145.

### Upper/Lower Limit Check

When direct connection is used with an NT20, upper and lower limits can be set for input numerical values to prevent erroneous values that are outside the valid range being stored in the numeral memory table or sent to the PLC. The upper/lower limit check is executed when the input numerical value has been confirmed: if the value is outside the valid range, the screen returns to its status before input.

**Note** In order to use the numerical value input setting safely, always use the upper/lower limit check function. (This function is not supported by the NT20-ST128. Take appropriate measures using the user application software.)

## 4-8-2 Types of Numeral Setting

There are two types of numeral setting: the numeric key type, and the thumbwheel type. The basic function of these two types is the same, but the screen displays and input methods are different.

A maximum of 50 input fields, including both numeric key and thumbwheel types, can be registered on one screen.

### Numeric Key Type

When a numerical value is input using touch switches to which numeric key functions have been allocated, the input numerical value is displayed on the screen. On pressing the return key after completing input, the input numerical value is written to the numeral memory table and sent to the host.

If there is more than one numeral setting input field, the field in which the input is to be made can also be selected with the numeric keys.

In order to perform numeric key input, it is necessary not only to create a numeral setting input field on the screen, but also to create the numeric keys to be used for input. (Refer to 4-8-4 *Using Numeric Keys*).

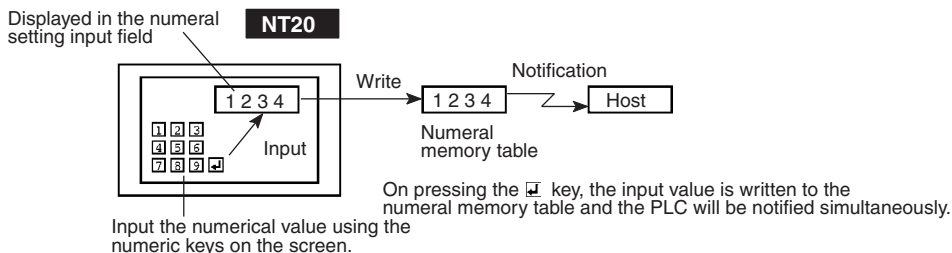

**Thumbwheel Type (Direct Connection Only)**

When using an NT20 with a direct connection, numerical values are input directly at the numeral setting input field using touch switches that increment or decrement each of the digits in the display when pressed. Each time the displayed numerical value is changed, the new displayed value is written to the numeral memory table and the host is simultaneously notified.

This means that, when using the Thumbwheel type of numeral setting, all that is required to input numerical values is to create the numeral setting input field on the screen.

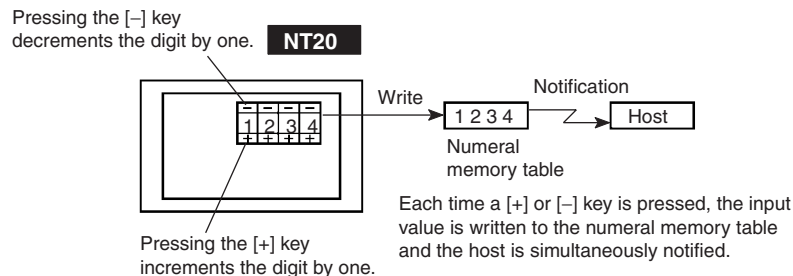

**4-8-3 Creating Numeric Keys**

In order to input numerical values using the numeral setting function, apart from the display area for the numeral setting, the numeric keys must also be created.

**Setting Screen Attributes**

The type of numeric keys can be selected using the numeral setting attributes of the screen attributes. There are two numeral setting attributes: “system” and “user”.

- Screen When “System” Is Specified

When a numeral setting area is created, numeric keys are automatically displayed. The display position and arrangement of the numeric keys are fixed. On this screen, only the types of numeric key shown in the figure below (system keys) are used.

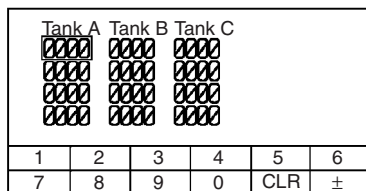

When using the NT20 with the numeral setting attribute set to “system”, apart from the numeric keys provided by the system, the touch switches allocated to system keys (↓, ↑, ↓) also have to be created (system key function). To enable input of hexadecimal values, it is also necessary to create numeric keys A through F.

With the NT20, if the numeral setting attribute is set to “system”, apart from the numeric keys prepared by the system, the touch switches allocated to system keys (↓, ↓, ↑) have to be created. (Refer to 4-7-3 System Key Functions on page 154.)

- When the Numeral Setting Attribute Is “User”

The display position and arrangement of the numeric keys can be set as required by allocating them to touch switches (see page 142).

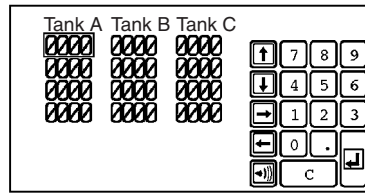

When the numeral setting attribute is set to “user”, numeric keys are created by using the control keys of the “input key” function. In addition, by using the character keys of the “input key” function, the one-byte characters 0 to 9 and A to F can be used as numeric keys.

**Note** Even when the numeral setting attribute is set to “user”, the same numeric keys as displayed with the “system” attribute can be displayed.

If “User” is selected for “Keypad” during data creation on the numeral setting screen, the numeric keys shown below are displayed.

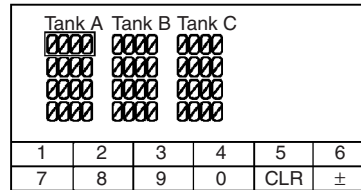

**Numeric Key Allocations**

The numeric keys are allocated to touch switches.

The numeric keys allocated to touch switches are specified when the touch switches are created. The following numeric keys (system keys) can be used for numeral setting.

For details on how to create touch switches, refer to *4-7 Touch Switches* on page 152.

Touch Switch Number	Numeric Key	Touch Switch Number	Numeric Key	Touch Switch Number	Numeric Key
227 (*)	Menu display	237	6	247	CLR
228	↑	238	7	248	±
229	↓	239	8	249	.
230	☺	240	9	250	HOME
231	0	241	A	251	↑
232	1	242	B	252	↓
233	2	243	C	253	←
234	3	244	D	254	→
235	4	245	E	255	↙
236	5	246	F		

(\*) Numeric key number 227 is the system menu display key.

When the touch switches allocated as numeric keys and system keys on a numeral setting screen are pressed, no notification is made to the PLC. This means that when using the NT20-ST128 (RS-232C), the touch switches numbered 227 to 255 cannot be used as normal touch switches on a numeral setting screen.

### 4-8-4 Using Numeric Keys

To input numerical data by using numeric keys, first select the numeral setting area into which the value is to be input, then input the numerical value by pressing the appropriate numeric keys.

#### Selecting the Numeral Setting Area for Data Input

Select the numeral setting area into which the numerical value is to be input by using either the numeric keys or the system keys.

- Selection with the Numeric Keys

Use the [HOME], [→], [←], [↑] and [↓] keys. By using these keys, the cursor can be shifted between numeral setting areas in the way shown in the figure below.

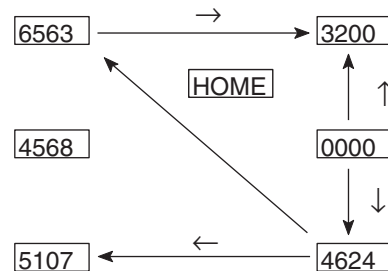

Pressing the [HOME] key will shift the cursor to the area whose top left corner has the smallest XY coordinate sum (the top left numeral setting input field in the example above).

- Selection with the System Keys

When the [↑] and [↓] system keys on the touch panel are pressed, the cursor moves between the numeral setting areas by following the order in which they were created using the Support Tool.

For example, if three numeral setting areas have been created, the cursor can be moved between them following the order of creation as follows.

[↑] key: 1st area → 2nd area → 3rd area → 1st area

[↓] key: 1st area → 3rd area → 2nd area → 1st area

If the “numeral setting” screen attribute is set to “system”, the order of cursor motion when the [↑] and [↓] system keys are used can be changed. For details, refer to the *NT Support Tool for Windows operation manual* (Cat. No. V061-E1-□).

#### Inputting Numerical Values

Input numerical values using the following numeric keys (touch switches): numerals (0 to 9, A to F), decimal point (.), sign (+,-), clear (CLR), and return (↵).

When inputting a numerical value that includes a decimal point, input the integer and decimal fraction separately. First input the integer, then press the decimal point key (.) and input the decimal fraction.

If the integer or decimal fraction exceed their respective allowable numbers of display digits, they are shifted to the left. In the system keys, however, the decimal point key (.) is not included. Therefore, it is necessary to create the decimal point key (.) apart from the ten keys of the system keys to input a numerical value including decimal fraction.

- Changing the Sign

When there is a sign display, pressing the sign ( $\pm$ ) key changes minus to plus or plus to minus.

- Confirming Input Numerical Values

Always press the return key as the final step when inputting a numerical value. When the return key is pressed, the displayed numerical value is written to the numeral memory table and at the same time the host is notified.

- Initial Operation of Input Keys

The sign key ( $\pm$ ), decimal point key (.), and alphabet key (A to F), operate as follows on initial use (first use after displaying the screen).

- Sign Key ( $\pm$ )

- The display is cleared to zero (assuming decimal input with sign display).

- Decimal Point Key (.)

- The display is cleared to zero, after which input starts from the decimal fraction digits (assuming decimal input with sign display).

- Alphabet Keys (A to F)

- The display is cleared to zero (assuming decimal input).

- Upper/Lower Limit Check

When the return key is pressed after inputting a numerical value, an upper/lower limit check is executed. If the input numerical value is outside the valid range, the data in the numeral memory table before input is redisplayed and the host is not notified.

## 4-8-5 Using The Thumbwheel Type of Numeral Setting

When using the thumbwheel type of numeral setting, numerical values are input by directly touching the incrementing/decrementing (+/-) keys.

### Numerical Value Input

Input numerical values by using the incrementing/decrementing (+, -) keys provided for each digit.

- Numerical Value Specification

When an incrementing/decrementing (+, -) key is touched, the numeral at the corresponding digit is incremented or decremented by one. Whenever a plus or minus key is touched, the host is notified of the changed value. There is no need to press the return key as is the case when using the numeric key type of numeral setting.

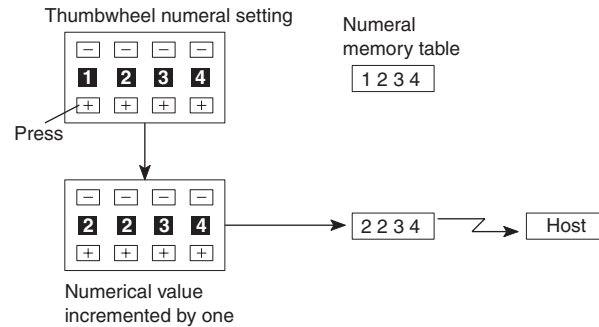

Numerical values cannot be set in thumbwheel type numeral setting fields by using numeric keys.

- Changing the Sign

In settings with a sign display, touching the incrementing/decrementing (+, -) keys at the digit where the sign is displayed will change plus to minus and minus to plus.

- Upper/Lower Limit Check

When using Ver.2 and later versions of the direct connection function, an upper/lower limit check is executed when the incrementing/decrementing (+, -) keys are pressed. If the input numerical value is outside the valid range, the data in the numeral memory table before the key was pressed is redisplayed and the host is not notified.

However, with thumbwheel type numeral setting, if the situation is such that with an upper limit of 1n..n, and a lower limit of 0m..m (where n and m are the values of each digit),  $n..n < m..m$ , it is not possible to carry digits upward or downward.

Example:

When the upper limit value is 1200 and the lower limit value is 201, if the initial value has three digits the value can be changed within the range 201 to 999, and if the initial value has four digits it can only be changed within the range 1000 to 1200.

This is because if an attempt is made to change the leftmost digit from 0 to 1, or from 1 to 0, an upper/lower limit value check is always performed.

In order to avoid this, either set the values so that  $n..n \leq m..m$ , or create another touch switch and write values to the host when digits are carried up or down.

## 4-8-6 Settings for Numeral Settings

The following settings are made for numeral settings during their creation with the Support Tool. Note that restrictions apply to several of the settings made for thumbwheel type numeral settings.

### Settings

- Referenced Numeral Memory Table Entry  
Set the number of the numeral memory table entry used to record the numerical value input using the numeral setting function.
- Number of Digits in the Input Numerical Value

Set the number of digits in the numerical values that can be input. A maximum of 8 digits (total of integer and decimal fraction parts) can be set. However, if there is a sign display, the maximum number of digits for negative values will be seven.

- Upper/Lower Limits

Set the upper limit and lower limit separately. The maximum number of digits in the set values is eight (or seven if there is a sign display).

When the upper limit value and lower limit value are set as negative values, set “F” as the eighth digit.

Example: Upper limit value or lower limit value is “-123” → F0000123.

- Display Attributes

Set attributes in the same way as for numeral display. For details, see *Numerals Which Can Be Displayed* on page 145.

### Restrictions and Additional Settings for Thumbwheel Type Numeral Settings

There are the following restrictions and additional items to set when creating thumbwheel type numeral settings.

- Number of Input Digits for Positive Values When There Is a Sign Display

When a sign display is set for a thumbwheel type numeral setting, a maximum of 7 digits can be input for positive values.

- Display Size

One of two sizes can be selected: “small” in which each digit comprises two touch switch units, and “medium”, in which each digit comprises three touch switch units. Note that if “small” is selected the area in which the numerical value is displayed is also the touch switch input area.

- Shape (End Plates)

Set which of the two shapes shown below will be used. One has “end plates” at right and left sides and the other does not.

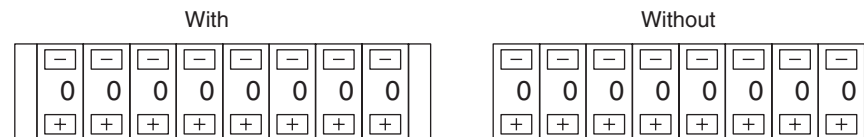

- Restrictions on Display Attributes

The following restrictions apply to display attributes.

- Character type: Wide size only
- Character enlargement: Standard only, regardless of the display size specification
- Zero suppress: No zero suppression only

Refer to *Numerals Which Can Be Displayed* on page 145.





# SECTION 5

## How to Use the Host Link/NT Link

This Section describes in concrete terms how to use the Host link/NT link communications with the NT20.

5-1	Overview of Direct Connection Operations . . . . .	166
5-1-1	Equipment and Settings Used in This Section . . . . .	166
5-1-2	Allocatable Bits and Words . . . . .	166
5-1-3	NT20 Status Control and Notification to PLC . . . . .	167
5-1-4	Switching the Screen Display . . . . .	172
5-1-5	Notifying the PLC of the Display Screen (to Display the Number of Currently Displayed Screen) . . . . .	174
5-2	Memory Tables and Bar Graphs . . . . .	177
5-2-1	Displaying the Contents of Allocated Words of Memory Table Entries	180
5-2-2	Changing Displayed Numerals or Character Strings (Changing the Contents of Allocated Words ... Direct Specification)	182
5-2-3	Changing Displayed Numerical Values or Character Strings (Changing the Contents of Allocated Words ... Indirect Specification)	184
5-2-4	Copying Memory Table Entries . . . . .	186
5-2-5	Upgrading Bar Graphs (Changing the Contents of Allocated Words)	189
5-3	Lamps, Touch Switches, Numeral Setting . . . . .	191
5-3-1	Allocation Bits and Display of Lamps . . . . .	191
5-3-2	Turning ON (Lit) and OFF (Unlit) the Lamps (Changing the Contents of Allocated Bits) . . . . .	192
5-3-3	Allocated Bits and Display of Touch Switches . . . . .	193
5-3-4	Lit (Flashing) and Unlit Touch Switch Status (Changing the Status of Allocated Bits) . . . . .	195
5-3-5	Notifying the Host That a Switch Has Been Pressed (Determining Touch Switch Status) . . . . .	196
5-3-6	Notification of Numbers to the PLC . . . . .	199
5-4	NT20 Status Control . . . . .	203
5-4-1	Controllable NT20 Functions . . . . .	203
5-4-2	How to Control NT20 Functions . . . . .	205
5-5	Notification of the Operating Status to the PLC (Determining the NT20 Operating Status) . . . . .	208
5-5-1	Ascertainable NT20 Status (Notified Operating Status) . . . . .	208
5-5-2	Reading the NT20 Operating Status . . . . .	209

## 5-1 Overview of Direct Connection Operations

This section explains allocated bits and words, control of the NT20 and PLC notification methods, and the actual procedures used for switching screens, thereby providing the basic information required to use the NT20-ST121-E host link, or NT link.

### 5-1-1 Equipment and Settings Used in This Section

The following equipment and settings are used in the examples in this section:

**Equipment** PT: NT20-ST121-E  
 PLC: CQM1H  
 Support Tool: NT Support Tool for Windows Ver. 4.8

**Support Tool Settings**

PT Model: NT20  
 PLC Vendor: OMRON

### 5-1-2 Allocatable Bits and Words

When the host link/NT link is used, the following bits and words are allocated to the PLC and used for the NT20 operation. The range of respective area varies with the type of PLC.

The allocations must be made without exceeding respective area range.

**OMRON PLCs**

Symbol	CS/CJ Series PLCs			
	Area Name	Allocated Bit	Allocated Word	
			Numeral	Character String
None	CIO Area	○	○	○
H	HR Area	○	○	○
A	AR Area	○	○	○
LR	LR Area (See note 1.)	○	○	○
T	TC Area Timer PVs	×	△	△
TU	TC Area Timer Completion Flags	×	×	×
C	TC area, Counter PVs	×	△	△
CU	TC area, Counter Completion Flags	×	×	×
W	WR	○	○	○
TK	Task Flags	×	×	×
D	DM Area	○	○	○
E	EM Area Current bank	○	○	○
E0_ to EC_	EM Area EM banks 0 to C	○	○	○

○: OK △ : 1 word only ×: NG

Symbol	C Series PLCs				CVM1/CV Series PLCs			
	Area Name	Allocated Bit	Allocated Word		Area Name	Allocated Bit	Allocated Word	
			Numeral	Character String			Numeral	Character String
None	IR Area	○	○	○	CIO Area	○	○	○
H	HR Area	○	○	○	---	---	---	---
A	AR Area	○	○	○	AR Area	○	○	○
LR	LR Area	○	○	○	---	---	---	---
T	TC Area Timer PVs	×	△	△	TC Area Timer PVs	---	---	---
TU	---	---	---	---	---	×	△	△
C	TC Area Counter PVs	×	△	△	TC Area Counter PVs	---	---	---
CU	---	---	---	---	---	×	△	△
W	WR	×	×	×	---	---	---	---
TK	---	---	---	---	---	---	---	---
D	DM Area	○	○	○	DM Area	○	○	○
E	EM Area (See note 2.) Current bank	○	○	○	EM Area Current bank	○	○	○
E0_ to EC_	---	---	---	---	---	---	---	---

○: OK △ : 1 word only ×: NG

When allocating words to a memory table entry, the allocation must not exceed the word area.

Since the AR area bits of the CV series PLCs are allocated to the system, they cannot be used for purposes other than the system use. However, reading from them is possible.

- Note**
- (1) LR 00000 to LR 00199 are converted to CIO 01000 to CIO 01199.
  - (2) The EM Area is supported only by the C200HX/HG/HE-(Z)E PLCs.
  - (3) A continuous areas of up to 2 words for a numeral memory table entry or 16 words for a character string memory table entry can be allocated.

### 5-1-3 NT20 Status Control and Notification to PLC

The following describes the fundamentals of the display elements, NT20 status control, and notification, which are the basics of the NT20 functions when using the host link/NT link.

For the detail method of use of the PT status control area and the PT status notify area, refer to 5-4 NT20 Status Control on page 203 and 5-5 Notification of the Operating Status to the PLC (Determining the NT20 Operating Status) on page 208.

#### Controlling the Display Elements by Using Allocated Bits and Words

The NT20 will operate as follows in the display element control operation.

##### NT20 Operation

1. The NT20 checks the allocation bits and words of the display elements and makes an inquiry to the PLC.
2. The PLC answers the NT20 about the bit and word data.

- The NT20 changes the display status according to the bits and words obtained from the PLC.

**NT20 Operation Example**

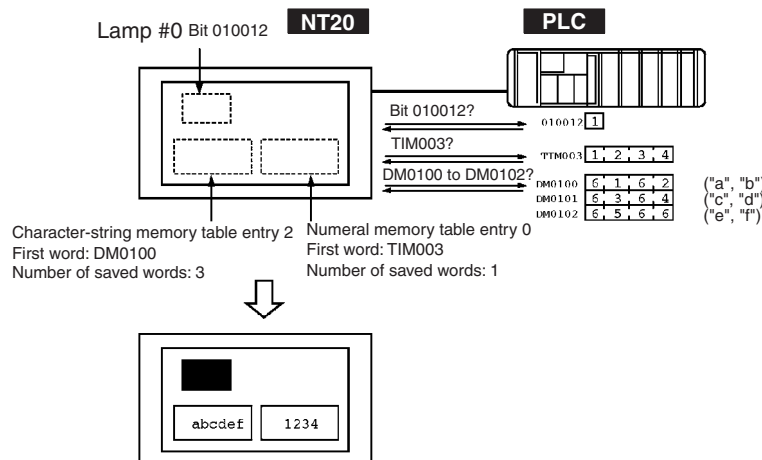

**Controlling the NT20 Status by Using Allocated Bits and Words .... PT Status Control Area (PLC to PT)**

The PT status control area (PLC to PT) is provided to control the NT20 status from the PLC. When data is written to this area in the PLC, the NT20 will read the data and operates according to the data. The PT status control area is configured as four consecutive words as shown below.

Word	15	14	13	12	11	10	9	8	7	6	5	4	3	2	1	0	Bit
n	Screen # (4-digit BCD)															Screen switch setting	
n+1	0		Copy source memory table entry # (3-digit BCD)													} Copy memory table setting	
n+2	Copy type		Copy destination memory table entry # (3-digit BCD)														
n+3	PT status control bit		0		0											PT status control	

The first word (word n) of the PT status control area must be set with the Support Tool.

- Screen Switch Settings (Refer to page 172.)  
Specify the screen number to switch the screen displayed on the NT20.
- Copy Memory Table Settings (Refer to page 187.)  
Specify the memory table entry number to copy the contents of a memory table internally in the NT20.  
Set the copy type to match the type of memory table entry to be copied:  
0: Character-string memory table  
1: Numeral memory table
- PT Status Control Bits (Refer to page 203.)  
These bits are switched ON and OFF to control the NT20 buzzer and back-light.

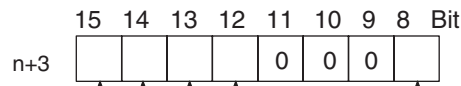

Item Controlled	1 (ON)	0 (OFF)
Screen display (Note 1)	ON	OFF
Processing priority registration (Note 2)	ON	OFF
Continuous buzzer	ON	OFF
Intermittent buzzer	ON	OFF
Backlight mode	ON	Flash

Note 1: When "ON" is set for screen display, the backlight is on; when "OFF" is set for screen display, the backlight is off.

Note 2: Priority registration is only valid when NT link (1:N) is set.

The PT status control area (PLC to PT) can be allocated to the following PLC areas.

Symbol	C-series	Allocation	CVM1/CV -series	Allocation	CS/CJ-series	Allocation
None	IR Area	○	CIO Area	○	CIO Area	○
H	HR Area	○	---	---	HR Area	Not for Host Link
A	AR Area	○	AR Area	×	AR Area	○
L	LR Area	○	---	---	LR Area (See note 1.)	Not for Host Link
T	TC Area Timer PVs	×	TC Area Timer PVs	×	TC Area Timer PVs	×
TU	---	---	---	---	TC area, Timer Completion Flags	×
C	TC Area Counter PVs	×	TC Area Counter PVs	×	TC Area Counter PVs	×
CU	---	---	---	---	TC area, Counter Completion Flags	×
W	---	---	---	---	WR	Not for Host Link
TK	---	---	---	---	Task Flags	×
D	DM Area	○	DM Area	○	DM Area	○
E	EM Area (See note 2.)	○	EM Area Current bank	Not for Host Link	EM Area Current bank	Not for Host Link
E0_to EC_	---	---	---	---	EM Area EM bank 0 to C	Not for Host Link

○: OK ×: NG

Since the AR area bits of the CV series PLCs are allocated to the system, they cannot be used for purposes other than the system use.

- Note** (1) LR 00000 to LR 00199 are converted to CIO 01000 to CIO 01199.  
 (2) The EM Area is supported only by the C200HX/HG/HE-(Z)E PLCs.

**Note** Make sure there is no duplication in the PT status control area allocations and PT status notify area allocations.

**Note** When NT link (1:N) is set, the PT status control area must be set for each connected PT.

**Notification of the Display Elements by Using Allocated Bits and Words**

The NT20 will operate as follows in the display element notification operation.

**NT20 Operation**

The NT20 will write any changes in the contents of the numeral or character-string memory table entry being displayed or pressing of a touch switch to the bits and words area in the PLC.

**NT20 Operation Example**

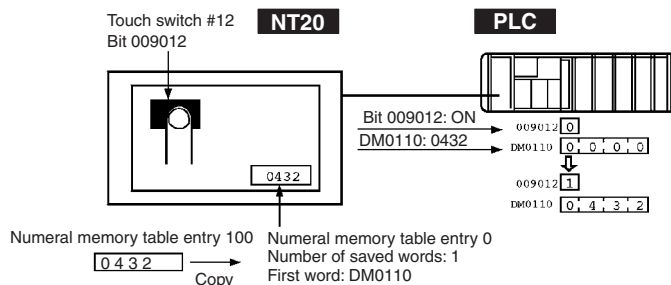

**Notification of the NT20 Status by Using Allocated Bits and Words ..... PT Status Notify Area (PT to PLC)**

The PT status notify area (PT to PLC) is provided to notify the PLC of NT20 status changes. When any NT20 status has changed, such change is written to this area in the PLC, and the PLC will read the data from this area to check the NT20 status.

The PT status notify area is configured as three consecutive words as shown below.

Word	15	14	13	12	11	10	9	8	7	6	5	4	3	2	1	0	Bit	
m	Screen # (4-digit BCD)															Screen being displayed		
m+1	0	Numeral memory table entry # (3-digit BCD)														Upgraded memory table entry		
m+2	PT status					0						0						PT status

The first word (word m) of the PT status notify area must be set with the Support Tool.

- **Currently Displayed Screen (refer to page 175)**  
The screen number displayed on the NT20 is written to this word. Simultaneously, the PT status screen switch strobe flag is set to ON (1). After the PLC is notified, this flag reverts to OFF (0). Checking the status of this flag will provide a simple method of checking if the NT20 display has switched.
- **Upgraded Memory Table Entry (Refer to page 200.)**  
The number of the numeral memory table entry is written to the word when the numeral memory table contents change due to the touch switch operation on the NT20. As the number of the numeral table entry is written, the PT status numeral setting strobe flag is simultaneously set ON (1). After the PLC is notified, this flag reverts to OFF (0). Checking the status of this flag will provide a simple method of checking if a number has been input from the NT20. Note that this function is not available with the character-string memory table.
- **PT Status (Refer to page 208.)**  
The NT20 operation status and other information are written with the ON or OFF of the bits as shown below.

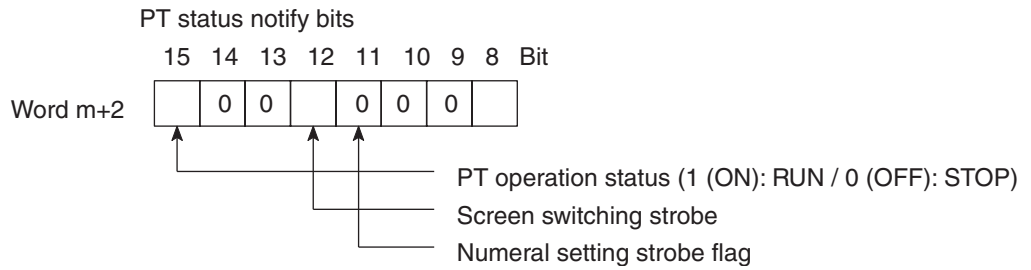

The PT status control area (PLC to PT) can be allocated to the following PLC areas.

Symbol	C-series	Allocation	CVM1/CV-series	Allocation	CS/CJ-series	Allocation
None	IR Area	○	CIO Area	○	CIO Area	○
H	HR Area	○	---	---	HR Area	Not for Host Link
A	AR Area	○	AR Area	×	AR Area	○
L	LR Area	○	---	---	LR Area (See note 1.)	Not for Host Link
T	TC Area Timer PVs	×	TC Area Timer PVs	×	TC Area Timer PVs	×
TU	---	---	---	---	TC area, Timer Completion Flags	×
C	TC Area Counter PVs	×	TC Area Counter PVs	×	TC Area Counter PVs	×
CU	---	---	---	---	TC area, Counter Completion Flags	×
W	---	---	---	---	WR	Not for Host Link
TK	---	---	---	---	Task Flags	×
D	DM Area	○	DM Area	○	DM Area	○
E	EM Area (See note 2.)	○	EM Area Current bank	Not for Host Link	EM Area Current bank	Not for Host Link
E0_to EC_	---	---	---	---	EM Area EM bank 0 to C	Not for Host Link

○: OK ×: NG

Since the AR area bits of the CVM1/CV series PLCs are allocated to the system, they cannot be used for purposes other than the system use.

The screen switching strobe or numeral setting strobe will turn ON in the following cases.

Screen switching strobe: Turns ON when a screen is changed due to an instruction from the PLC or an operation at the PT.

Numeral setting strobe: Turns ON when the contents of a numeral memory table entry is changed due to an operation at the PT.

These strobes turn OFF automatically after the PLC is notified, allowing the operating status of the PT to be easily investigated. If a CVM1/CV-series CPU Unit is connected and set for asynchronous operation, the status of the strobes cannot be read dependably.

**Note**

- (1) LR 00000 to LR 00199 are converted to CIO 01000 to CIO 01199.
- (2) The EM Area is supported only by the C200HX/HG/HE-(Z)E PLCs.
- (3) Make sure there is no duplication in the PT status control area allocations and PT status notify area allocations.



- (4) When NT link (1:N) is set, the PT status control area must be set for each connected PT.

### 5-1-4 Switching the Screen Display

The following describes the procedure used to switch the NT20 screen display by controlling from the PLC.

**Note** The display screen can be switched also by pressing a touch switch during the operation after registering a screen number to the touch switch. For this function, refer to the 4-7-2 *Screen Switching Function* on page 154.

To switch the NT20 screen display by controlling from the PLC, write a screen number at the “screen switch setting” in the PT status control area.

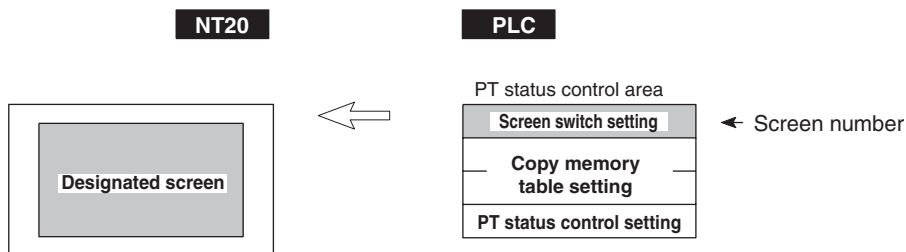

#### Screen Switch Setting in the PT Status Control Area

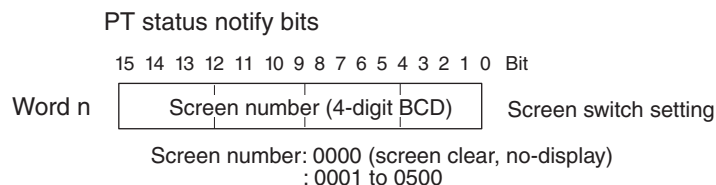

- Available Allocation Words

The PT status control area (PLC to PT) can be allocated to the following PLC areas.

Symbol	C-series	Allocation	CVM1/CV-series	Allocation	CS/CJ-series	Allocation
None	IR Area	○	CIO Area	○	CIO Area	○
H	HR Area	○	---	---	HR Area	Not for Host Link
A	AR Area	○	AR Area	×	AR Area	○
L	LR Area	○	---	---	LR Area (See note 1.)	Not for Host Link
T	TC Area Timer PVs	×	TC Area Timer PVs	×	TC Area Timer PVs	×
TU	---	---	---	---	TC area, Timer Completion Flags	×
C	TC Area Counter PVs	×	TC Area Counter PVs	×	TC Area Counter PVs	×
CU	---	---	---	---	TC area, Counter Completion Flags	×
W	---	---	---	---	WR	Not for Host Link
TK	---	---	---	---	Task Flags	×
D	DM Area	○	DM Area	○	DM Area	○

E	EM Area (See note 2.)	○	EM Area Current bank	Not for Host Link	EM Area Current bank	Not for Host Link
E0_to EC_	---	---	---	---	EM Area EM bank 0 to C	Not for Host Link

○: OK ×: NG

Since the AR area bits of the CVM1/CV series PLCs are allocated to the system, they cannot be used for purposes other than the system use. The range of respective area varies with the type of PLC.

- Note**
- (1) LR 00000 to LR 00199 are converted to CIO 01000 to CIO 01199.
  - (2) The EM Area is supported only by the C200HX/HG/HE-(Z)E.

- 1,2,3...**
1. Use the Support Tool to allocate the PT status control area (PLC to PT) to the PLC memory.
  2. Create a PLC program to write the number of the displayed screen to the “screen switch setting word” in the PT status control area.

Use a 4-digit BCD (binary-coded decimal) value to set a screen number. If a screen has been switched by operating the PT status control area (PLC to PT), the contents of the “currently displayed screen word” in the PT status notify area (PT to PLC) also change.

- Screen Switching Timing

The NT20 screen switches when the contents of the “screen switch setting” have changed. To re-specify the number of the currently specified screen, first write the value 0000 to clear the screen before writing the appropriate screen number.

- Use of the Screen Switching Strobe

Create a program to read the number of the currently displayed screen and to write the number to the “screen switch setting word” at the leading edge of the “screen switching strobe” of the PT status notify area. This program enables screen switching by using the touch switches on the NT20 and eliminates repeated setting of the same screen number. If the screen switching is not executed on the NT20, the screen switching strobe does not need to be checked.

For the screen switching strobe, refer to the “Notifying the PLC of the Display Screen,” below.

- Continuous Screens and Overlapping Screens

Continuous or overlapping screens can be displayed by designating the parent screen. If a child screen is designated, only the child screen is displayed.

For the continuous and overlapping screens, refer to 4-3-1 *Classification of Screens* on page 140.

**Example of Display Screen Switching**

This example operates the PLC switch (bit) to switch the NT20 display screen.

- Support Tool Settings

Make the following settings with the Support Tool:

PT status control area: Word 0100

PT status notify area: Word 0110

Screen number to be created: Screen #2 and #3

- PLC Ladder Program

Create a PLC ladder program as follows:

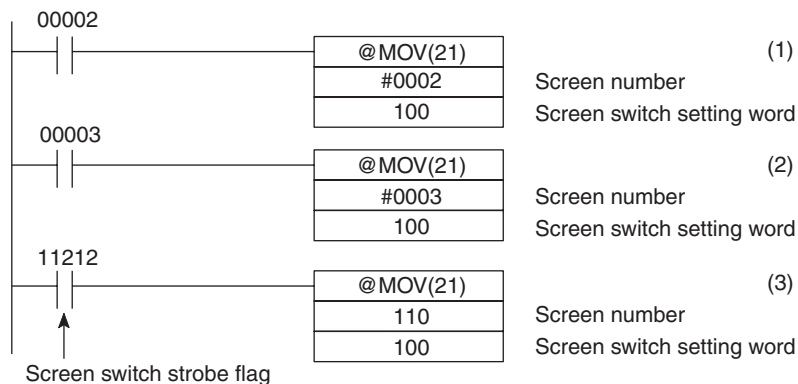

• Program Operation

- 1,2,3...
1. Screen #2 is displayed on the NT20 when bit 00002 turns ON.
  2. Screen #3 is displayed on the NT20 when bit 00003 turns ON.
  3. When the screen switch strobe flag turns ON, the number of the currently displayed screen is read and written to the currently displayed screen word in the PT status notify area. In this case, the NT20 will not write the same screen twice.

### 5-1-5 Notifying the PLC of the Display Screen (to Display the Number of Currently Displayed Screen)

The following describes the processing to display the number of currently displayed screen of the NT20.

This processing reads the data from the PLC status notify area.

To indicate that the screen has switched, use the screen switch strobe flag.

To display the number of the currently displayed screen, use the currently displayed screen word.

When the screen has switched, the NT20 notifies the PLC of the following in PT status notify area (PT to PLC) allocated in the PLC.

Screen switch notification: Screen switch strobe flag of the PT status word  
 New screen number: Currently displayed screen word

By reading the currently displayed screen word when the screen switch strobe flag has turned ON, the number of the currently displayed screen on the NT20 is displayed.

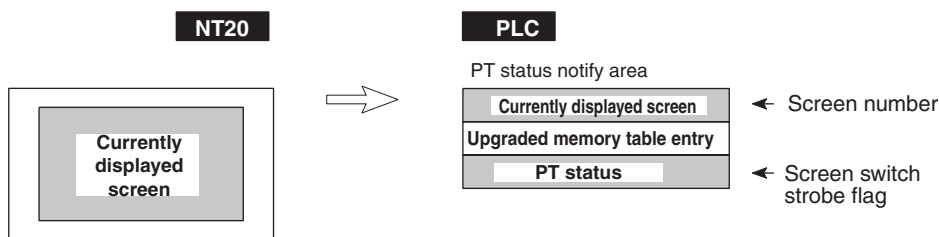

**Currently Displayed Screen and PT Status Words in the PT Status Notify Area**

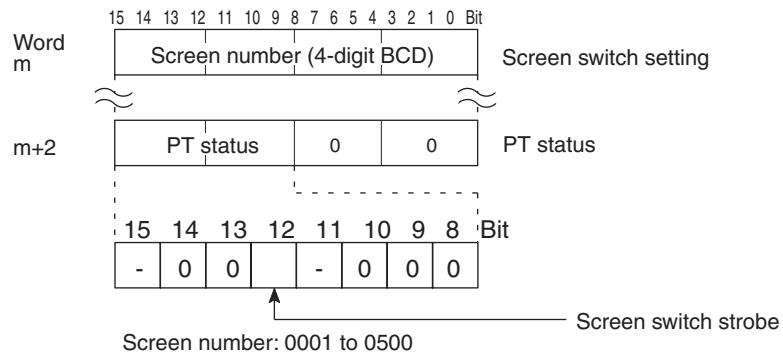

Use a 4-digit BCD (binary-coded decimal) value to set a screen number. The screen switch strobe bit reverts to OFF (0) after the PLC is notified.

• Available Allocation Words

The PT status notify area (PT to PLC) can be allocated to the following PLC areas.

Symbol	C-series	Allocation	CVM1/CV-series	Allocation	CS/CJ-series	Allocation
None	IR Area	○	CIO Area	○	CIO Area	○
H	HR Area	○	---	---	HR Area	Not for Host Link
A	AR Area	○	AR Area	×	AR Area	○
L	LR Area	○	---	---	LR Area (See note 1.)	Not for Host Link
T	TC Area Timer PVs	×	TC Area Timer PVs	×	TC Area Timer PVs	×
TU	---	---	---	---	TC area, Timer Completion Flags	×
C	TC Area Counter PVs	×	TC Area Counter PVs	×	TC Area Counter PVs	×
CU	---	---	---	---	TC area, Counter Completion Flags	×
W	---	---	---	---	WR	Not for Host Link
TK	---	---	---	---	Task Flags	×
D	DM Area	○	DM Area	○	DM Area	○
E	EM Area (See note 2.)	○	EM Area Current bank	Not for Host Link	EM Area Current bank	Not for Host Link
E0_to EC_	---	---	---	---	EM Area EM bank 0 to C	Not for Host Link

○: OK    ×: NG

Since the AR area bits of the CV-series PLCs are allocated to the system, they cannot be used for purposes other than the system use.

The range of respective area varies with the type of PLC.

- Note**
- (1) LR 00000 to LR 00199 are converted to CIO 01000 to CIO 01199.
  - (2) The EM Area is supported only by the C200HX/HG/HE-(Z)E.

- 1,2,3...**
1. Use the Support Tool to allocate the PT status notify area (PT to PLC) to the PLC memory.

2. Create a PLC program to read the “currently displayed screen word” in the PT status notify area when the “screen switch strobe flag” in the PT status notify area has turned ON.

**Note** The contents of the “currently displayed screen word” are updated also by switching the screen by pressing a touch switch on the NT20.

For this function (standalone function or screen switch function), refer to the *Standalone Function* on page 154.

- Continuous Screens and Overlapping Screens

When a continuous or overlapping screen is displayed, the number of the parent screen is written to the “currently displayed screen word”.

For the continuous and overlapping screens, refer to the *4-3-1 Classification of Screens* on page 140.

**Example of Reading the Number of Currently Display Screen**

This example gives a PLC program that reads the screen number each time the screen is switched. In this example, the number of the previous screen is also stored.

- Support Tool Settings

Make the following settings with the Support Tool:

PT status notify area: Word 0110

- PLC Ladder Program

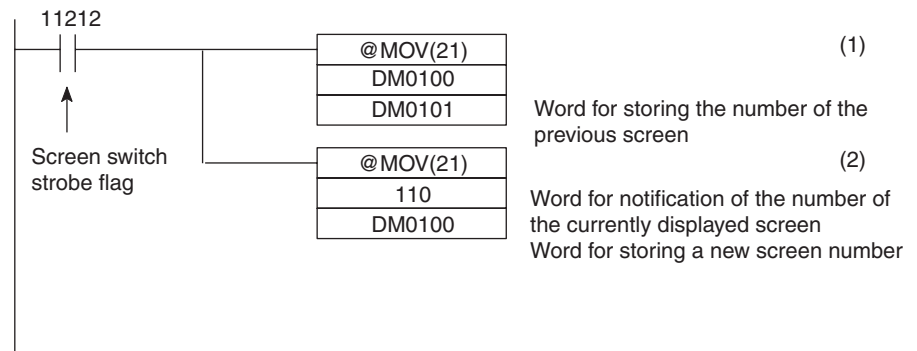

- Program Operation

**1,2,3...**

1. When the NT20 screen display switches and the screen switch strobe flag (bit 11212) turns ON, the contents of DM0100 are transferred to DM0101. The number of the previously displayed screen is stored in word 0101.
2. The new screen number indicated by the NT20 is read and transferred to DM0100. The number of the currently displayed screen is stored in DM0100.

## 5-2 Memory Tables and Bar Graphs

### Displaying and Referencing Character String Memory Table Contents

Since the character-string memory table entries can be allocated to the words in the PLC, the PLC can write data to the character-string memory table entries or the initial values can be set when creating the screen data.

Automatic updating is performed to ensure that the currently displayed NT20 character string memory table contents and PLC word contents always match each other.

There are two methods for referencing character string memory table entries used for character string display, as follows:

- Direct specification
- Indirect specification

**Direct Specification**  
 Direct specification is a method of specification in which the contents of displayed memory table entries are directly correlated with the contents of the allocated words.

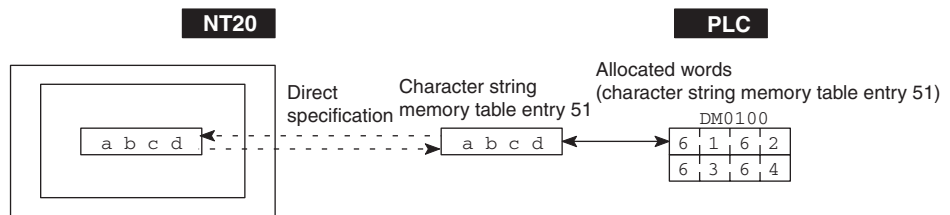

- Indirect Specification (Direct Connection Only)

In indirect specification, even if the displayed data is a character string, the display is correlated with a numeral memory table entry. The contents (numerical value) of this numeral memory table entry are regarded as a character string memory table entry number and the contents of the table entry with this number is displayed.

Up to 50 numeral displays and 50 character string displays can be specified on one screen by using indirect specification.

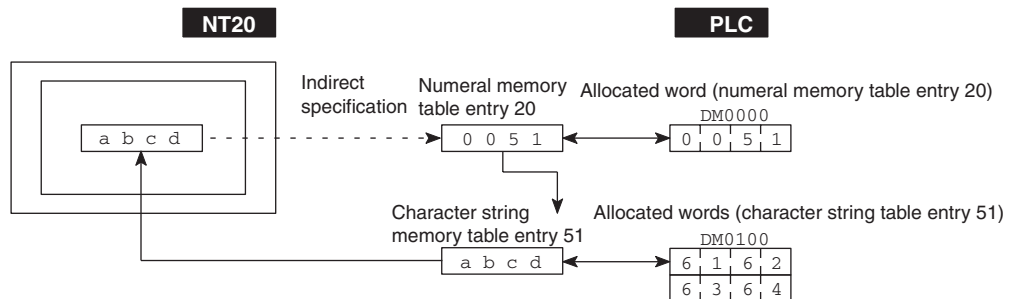

This specification method is a little complex, but it allows the display to be changed more easily according to the circumstances. In the example above, if 1 were added to the contents of memory table entry 20 to give 52, the contents of memory table entry 52 would be displayed instead.

The memory table entries used for display can also be allocated to areas in the PLC, so that the display can also be changed in response to changes in the data to be displayed (i.e., the contents of character string memory table entry 51 in the example above).

However, in comparison with direct specification, indirect specification requires more time for processing.

### Setting the Words of the Character-String Memory Table

When creating the screen data by using the Support Tool, make the following settings for each numbered character string:

- Initialization Setting

Set whether or not the PLC words are initialized with the character-string memory table initial value registered to the screen data memory when the main power supply is turned ON or reset.

- Number of Registration Words

Set the number of words within 16 words required for registering the character-string data. One word can store two normal-size characters.

- Setting the Words for the Character-string Memory Table Entries

The character-string memory table entries can be allocated to the following PLC words. Set the word type and the first word.

Symbol	C-series	Allocation	CVM1/CV -series	Allocation	CS/CJ-series	Allocation
None	IR Area	○	CIO Area	○	CIO Area	○
H	HR Area	○	---	---	HR Area	Not for Host Link
A	AR Area	○	AR Area	×	AR Area	○
L	LR Area	○	---	---	LR Area (See note 1.)	Not for Host Link
T	TC Area Timer PVs	×	TC Area Timer PVs	×	TC Area Timer PVs	×
TU	---	---	---	---	TC area, Timer Completion Flags	×
C	TC Area Counter PVs	×	TC Area Counter PVs	×	TC Area Counter PVs	×
CU	---	---	---	---	TC area, Counter Completion Flags	×
W	---	---	---	---	WR	Not for Host Link
TK	---	---	---	---	Task Flags	×
D	DM Area	○	DM Area	○	DM Area	○
E	EM Area (See note 2.)	○	EM Area Current bank	Not for Host Link	EM Area Current bank	Not for Host Link
E0_to EC_	---	---	---	---	EM Area EM bank 0 to C	Not for Host Link

○: OK    ×: NG

Since the AR area bits of the CVM1/CV-series PLCs are allocated to the system, they cannot be used for purposes other than the system use.

If the “number of registration words x 2” (“word setting window”) set with the Support Tool is larger than the “number of character digits” (“character-string display setting” window), the character string may be broken halfway.

- Note**
- (1) LR 00000 to LR 00199 are converted to CIO 01000 to CIO 01199.
  - (2) The EM Area is supported only by the C200HX/HG/HE-(Z)E PLCs.

### Displaying and Referencing Numeral Memory Table Contents

Since the numeral memory table entries can be allocated to the words in the PLC, the PLC can write data to the numeral memory table entries or the initial values can be set when creating the screen data.

Also, by relating the numeral memory table entries with the bar graphs, the bar graphs corresponding to the data of the numeral memory table entries can be displayed.

During the operation, the display contents are automatically updated so that the contents of the numeral memory table entry being displayed are the same as that of the PLC word.

There are two methods for referencing numeral memory table entries used for numeral displays, as follows:

- Direct specification
- Indirect specification

**Note** The only method available for numeral memory table entries used for graphs and numeral settings is direct specification.

• Direct Specification

Direct specification is a method of specification in which the contents of displayed memory table entries are directly correlated with the contents of the allocated words.

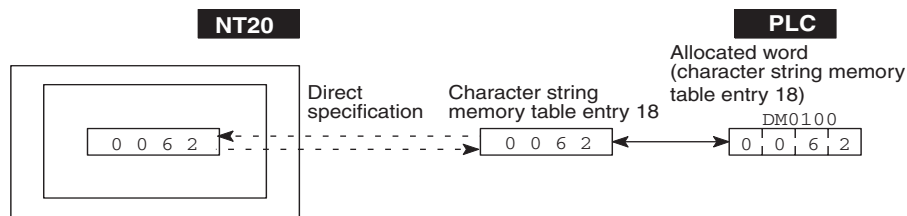

• Indirect Specification

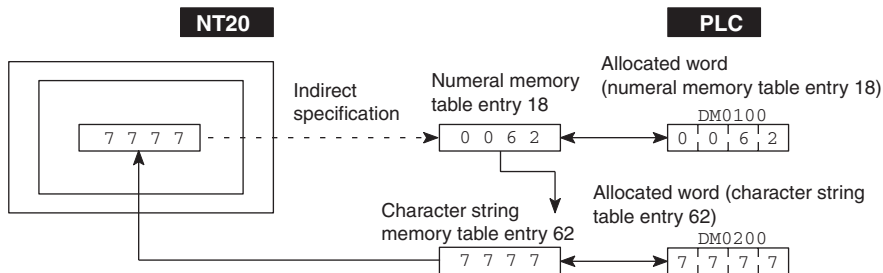

With indirect specification, the contents (numerical value) of the specified numeral memory table entry are regarded as a memory table entry number and the contents of the table entry with this number is displayed.

Up to 50 numeral displays and 50 character string displays can be specified on one screen by using indirect specification.

This specification method is a little complex, but it allows the display to be changed more easily according to the circumstances. In the example above, if one were added to the contents of memory table entry 18 to give 63, the contents of memory table entry 63 would be displayed instead.

The memory table entries used for display can also be allocated to areas in the PLC, so that the display can also be changed in response to changes in the data to be displayed (i.e., the contents of character string memory table entry 62 in the example above). However, in comparison with direct specification, indirect specification requires more time for processing.

**Setting the Words of the Numeral Memory Table**

When creating the screen data by using the Support Tool, make the following settings for each numbered numeral:



- Initialization Setting

Set whether or not the PLC words are initialized with the numeral memory table initial value registered to the screen data memory when the main power supply is turned ON or reset.

- Number of Registration Words

Set the number of words within 2 words required for registering the numeral data. One word can store up to 4 digits. Two words can store up to 8 digits.

- Setting the Words for the Numeral Memory Table

The numeral memory table entries can be allocated to the following PLC words. Set the word type and the first word.

Symbol	C-series	Allocation	CVM1/CV-series	Allocation	CS/CJ-series	Allocation
None	IR Area	○	CIO Area	○	CIO Area	○
H	HR Area	○	---	---	HR Area	Not for Host Link
A	AR Area	○	AR Area	×	AR Area	○
L	LR Area	○	---	---	LR Area (See note 1.)	Not for Host Link
T	TC Area Timer PVs	△	TC Area Timer PVs	△	TC Area Timer PVs	△
TU	---	---	---	---	TC area, Timer Completion Flags	×
C	TC Area Counter PVs	△	TC Area Counter PVs	Not for Host Link	TC Area Counter PVs	△
CU	---	---	---	---	TC area, Counter Completion Flags	×
W	---	---	---	---	WR	Not for Host Link
TK	---	---	---	---	Task Flags	×
D	DM Area	○	DM Area	○	DM Area	○
E	EM Area (See note 2.)	○	EM Area Current bank	Not for Host Link	EM Area Current bank	Not for Host Link
E0_to EC_	---	---	---	---	EM Area EM bank 0 to C	Not for Host Link

○: OK   △ : 1 word only   ×: NG

Since the AR area bits of the CVM1/CV series PLCs are allocated to the system, they cannot be used for purposes other than the system use.

- Note**
- (1) LR 00000 to LR 00199 are converted to CIO 01000 to CIO 01199.
  - (2) The EM Area is supported only by C200HX/HG/HE-(Z)E PLCs.

## 5-2-1 Displaying the Contents of Allocated Words of Memory Table Entries

The relationship between the contents of the allocated words of numeral and character string memory table entries and the display is described below.

- Contents of the Numeral Memory Table

Numerals are stored in the allocated words as shown below.

**Stored as a Single Word**

15 to 12	11 to 8	7 to 4	3 to 0	Bit
Digit 4	Digit 3	Digit 2	Digit 1	

Example: 1234

15 to 12	11 to 8	7 to 4	3 to 0	Bit
1	2	3	4	

**Stored as a Double Word**

Word	15 to 12	11 to 8	7 to 4	3 to 0	Bit
Start	Digit 4	Digit 3	Digit 2	Digit 1	
Start+ 1	Digit 8	Digit 7	Digit 6	Digit 5	

Example: 12345678

Word	15 to 12	11 to 8	7 to 4	3 to 0	Bit
Start	5	6	7	8	
Start+ 1	1	2	3	4	

- **Displaying a Numeral Memory Table Entry**

Numerals can be displayed in three different ways according to the contents of the numeral memory table, as described below.

The most significant digit (digit 4 of a single word or digit 8 of a double word) is processed in different ways.

Hexadecimal display: All digits are handled as stored in the allocated words.

Decimal display without signs: If the most significant digit is “F”, it is handled as “0”, and the most significant digit other than “F” and other digits are handled as stored in the allocated words.

Decimal display with signs: If the most significant digit is “F”, it is handled as “-” (minus sign), and the most significant digit other than “F” and other digits are handled as stored in the allocated words.

**Numeral Memory Table Display Examples**

- When the Data Is Numeral Data (0 to 9)

Start	3   4   5   6	→	Decimal without sign	123456
Start + 1	F   0   1   2		Decimal with sign	-123456
			Hexadecimal	F0123456

- When the Data Contains Characters (A to F)

Start	3   B   5   6	→	Decimal without sign	123B56
Start + 1	F   0   1   2		Decimal with sign	-123B56
			Hexadecimal	F0123B56

If the hexadecimal data (A to F) are stored when the decimal display has been set, the alphabets are displayed.

If the number of display digits has been set to be smaller than the maximum number of digits of the registration words (4 digits for 1 word; 8 digits for 2 words), the contents of the allocated words are not displayed and "\*" symbols will be displayed at all digits.

If the most significant digit is "F" when "decimal with signs" has been set, the numeral is handled as a negative number. The maximum number of digits of the negative number becomes smaller than that of the positive number by 1 digit.

The actual display will vary according to the "zero suppress" setting and decimal fraction setting as well as the contents described above. Refer to the "NT Support Tool for Windows Operation Manual" (Cat. No. V061-E1-□).

- Contents of the Character-string Memory Table

A character string is stored in the allocated words beginning with the first word in normal-size characters.

Two normal-size characters are stored in one word. One memory table entry can store up to 16 words (32 characters).

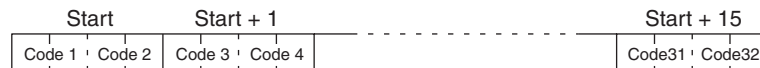

**Character-string Memory Table Display Example**

To display the characters in order, allocate the characters as follows:

"A"=41H, "B"=42H	Start	4   1   4   2	→	"ABCDEFGH"
"C"=43H, "D"=44H	Start + 1	4   3   4   4		
"E"=45H, "F"=46H	Start + 2	4   5   4   6		
"G"=47H, "H"=48H	Start + 3	4   7   4   8		

**5-2-2 Changing Displayed Numerals or Character Strings (Changing the Contents of Allocated Words ... Direct Specification)**

The following explains the actual procedure for changing the contents of allocated words referenced by direct specification in order to change numerical values and character strings displayed by the NT20.

For the situation when using indirect specification, refer to 5-2-3 *Changing Displayed Numerical Values or Character Strings (Changing the Contents of Allocated Words ... Indirect Specification)* on page 184.

Numerals and character strings can be changed also by making a copy of the memory table entries. Refer to "Copying Memory Table Entries," below.

To change the numerals or character strings displayed on the NT20, make changes with the numeral or character-string memory table. To make changes with the numeral or character-string memory table of the NT20, change the contents of words by the PLC.

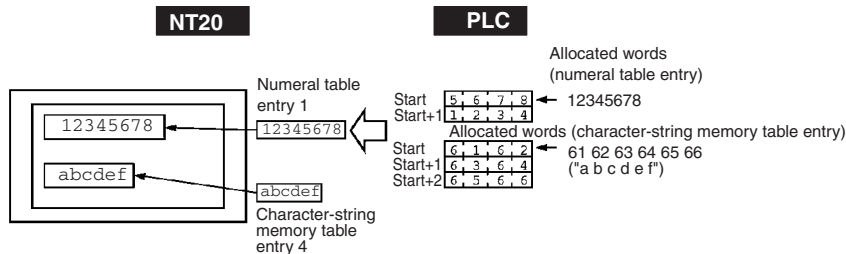

**Note** This method is convenient when changing data has to be displayed: for example when monitoring the contents of PLC words.

- 1,2,3...**
1. Use the Support Tool to allocate the numeral and character-string memory table entries to the PLC memory.
  2. Register the memory table entries for the numerals and character strings to be displayed when creating the screen data by using the Support Tool. Specify "direct" as the reference method.

To display a character string, use "character display" and specify the character-string memory table entry by using the Support Tool.

To display numerals, use "numeral display" and specify the numeral memory table entry by using the Support Tool.

3. Create a PLC program to write the contents of numerals and character strings to be displayed on the NT20 to the PLC words.

• Important Points When Writing a Character String

If a character string to be written is smaller than "allocated word x 2", fill up the vacant space with normal-size spaces (20H). If unnecessary characters are left in the area, the character string will not be displayed correctly.

**Application Example of the Numeral Memory Table Entries Allocated to the PLC Words**

This example gives the procedure to directly display the contents of the words allocated as the numeral memory table entries in the PLC memory. The NT20 screen display will change as the contents of the PLC word change.

• Support Tool Settings

Allocate the memory as shown below by using the Support Tool.

Numeral memory table entry #1: DM0000 (allocated words: 2 words)

Numeral memory table entry #2: DM0002 (allocated words: 1 word)

Screen numbers to be created:#1 and #2

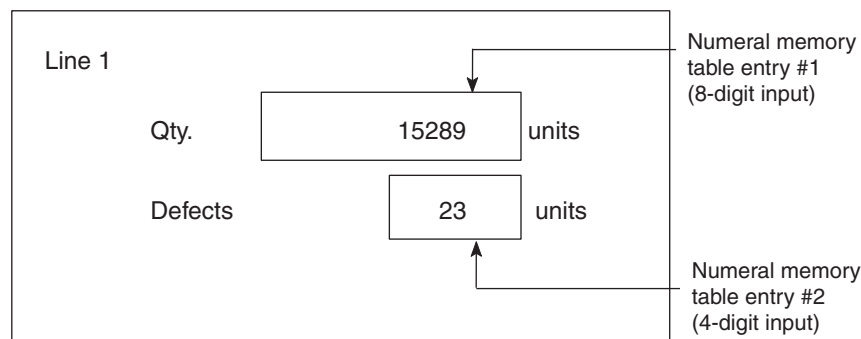

• PLC Ladder Program

Create a PLC ladder program as follows:

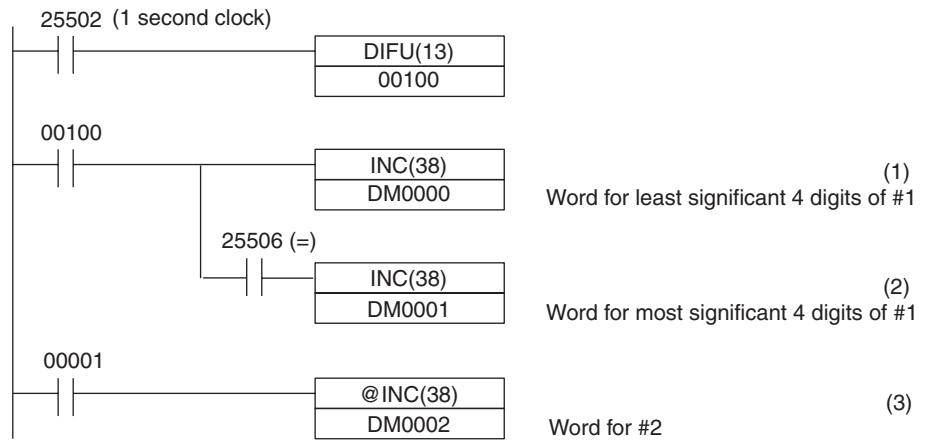

• Program Operation

- 1,2,3...**
1. The contents of word DM0000 are incremented by 1 each second. The value displayed on the NT20 in numeral memory table entry #1 increases by 1 each second.
  2. When the counter in (1) above causes an increase in the most significant digits, the contents of word DM0001 are incremented by 1 each second. The value displayed on the NT20 in numeral memory table entry #1 most significant digits increases by 1.
  3. When bit 00001 turns ON, the contents of DM0002 are incremented by 1. The value displayed on the NT20 in numeral memory table entry #2 increases by 1.

### 5-2-3 Changing Displayed Numerical Values or Character Strings (Changing the Contents of Allocated Words ... Indirect Specification)

The following explains how to change numerical values or character strings displayed by the NT20 by changing the contents of the referenced allocated words using indirect specification.

If using direct specification, refer to *5-2-2 Changing Displayed Numerals or Character Strings (Changing the Contents of Allocated Words ... Direct Specification)* on page 182.

Numerical values and character strings can also be changed by making a copy of the memory table entries. Refer to *5-2-4 Copying Memory Table Entries* on page 186.

In indirect specification, a numeral memory table entry is specified to display a numerical value or character string. The numerical value stored in this numeral memory table entry ("39" in the figure below) is taken as the number of the memory table entry whose contents are to be displayed.

Either of the following two methods can be used to change the display when indirect specification is used:

- 1,2,3...**
1. Changing the number for the memory table entry whose contents are to be displayed. (In the example in the figure below, this would mean changing the contents of numeral memory table entry 41.)
  2. Changing the contents of the memory table entry used for display (In the example in the figure below, this would mean changing the contents of character string memory table entry 39.)

Here, the method for changing the display using method 1) is explained. For details on method 2), refer to the explanations on direct specification on page 182 and 5-2-4 Copying Memory Table Entries on page 186.

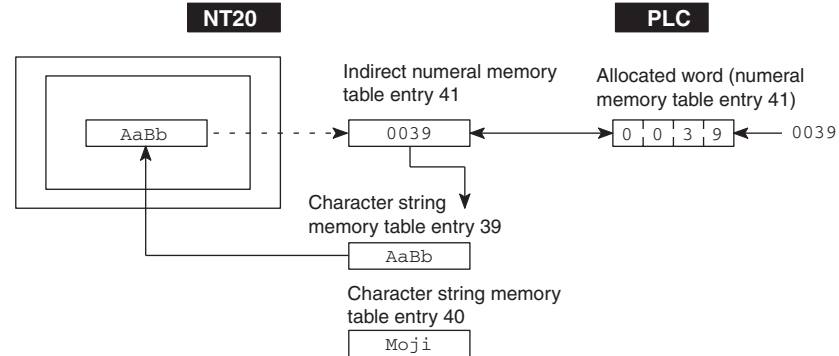

**Note** This method is convenient when switching the display at the same location, for example when monitoring a series of words, or when using unique codes to specify individual character strings, etc.

- 1,2,3...**
1. Set the PLC area for allocation of the numeral memory table entry to be referenced in indirect specification using the Support Tool.
  2. When using the Support Tool to create screen data, register on the screen the numeral memory table entry referenced in indirect specification. Specify the “indirect” option for the reference method. In the case of a character string, use the “character display” function of the Support Tool to specify the numeral memory table entry. In the case of a numerical value, use the “numeral display” function of the Support Tool to specify the numeral memory table entry.
  3. Use the “table edit” function of the Support Tool to write the actually displayed data to the memory table entry for display. If displaying a numerical value, use a numeral memory table entry and if displaying a character string use a character string memory table entry.
  4. Create a PLC program to change the contents of the word allocated to the numeral memory table referenced in the indirect specification.
    - **Precautions on Writing Memory Table Entry Numbers**  
When writing the number of the memory table for display to the numeral memory table entry referenced in indirect specification, always specify it in BCD. Also, be sure to specify a number within the range of memory table entry numbers that actually exist (0 to 127).  
If the contents of the numeral memory table entry for indirect specification are specified in hexadecimal format, or the number specified is outside the valid range for memory table entry numbers, the display is not updated.
    - **Precautions on Writing Character Strings**  
The points to note when displaying character strings are the same as those described for direct specification. Refer to *Important points when writing a character string* to page 149.

### Example Use of Indirect Specification

This example shows a case where the displayed character string is changed by incrementing the contents of the allocated word of the numeral memory table entry referenced in indirect specification.

- **Settings with the Support Tool**  
Make the following settings with the Support Tool.

Numeral memory table entry number 51: DM 0000 (number of registered words: 1)

Character string memory table entry number 100: "NT610G" (6 digits)

Character string memory table entry number 101: "NT610C" (6 digits)

Character string memory table entry number 102: "NT20 " (6 digits)

Character string memory table entry number 103: "NT600S" (6 digits)

Data registered for the screen: numeral memory table entry number 51.

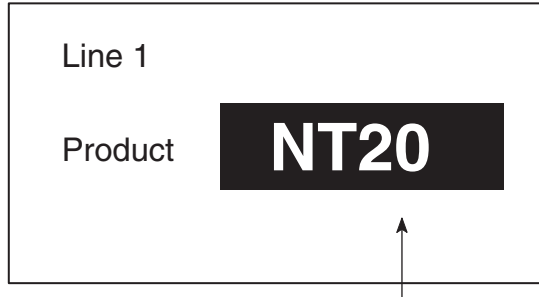

Numeral memory table number 51 specified in indirect specification of character string display

• PLC Program

Create the PLC ladder program as follows:

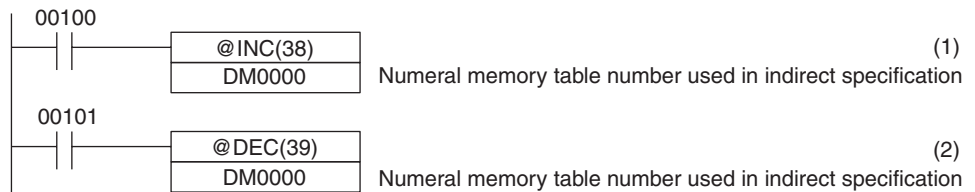

• Program Operation

1,2,3...

1. Each time bit 00100 comes ON, the display on the NT20 screen changes according to one of the steps in the following sequence: "NT610G" → "NT610C" → "NT20" → "NT600S".
2. Each time bit 00101 comes ON, the display on the NT20 screen makes changes according to one of the steps in the following sequence: "NT600S" → "NT20" → "NT610C" → "NT610G".

In this example, the contents of numeral memory table entry number 51 referenced in indirect specification are not checked. Make sure that the contents of numeral memory table entry number 51 stay within the range of 0100 to 0103 when the program is actually used.

### 5-2-4 Copying Memory Table Entries

The following describes the procedure to change displayed numerals or character strings by copying the contents of a memory table entry.

Numerals and character strings can be changed also by changing the contents of the allocated words. Refer to 5-2-2 *Changing Displayed Numerals or Character Strings (Changing the Contents of Allocated Words ... Direct Specification)* on page 182 explained before.

To change the numerals or character strings displayed on the NT20, copy the data between the numeral or character-string memory table entries by using the "copy memory table setting" of the PT status control area.

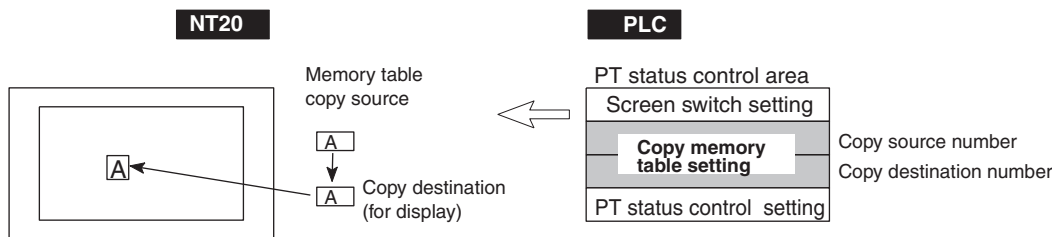

Write a memory table entry number to the copy memory table setting area in the PT status control area in the PLC memory. Data will be copied between the memory table entries in the NT20 and the displayed value will change accordingly.

**Note** This procedure is convenient to switch predetermined values or character strings according to the situation. By preparing several units of contents, various contents can be displayed by switching them to suit the situation.

**Copy Memory Table Settings of the PT Status Control Area**

	15	14	13	12	11	10	9	8	7	6	5	4	3	2	1	0	Bit
Word n+1	0		Copy source memory table entry # (3-digit BCD)											) Copy memory table settings			
n+2	Copy type		Copy destination memory table entry # (3-digit BCD)														

Copy type:

- 0: Copy between the character-string memory table entries
- 1: Copy between the numeral memory table entries

Copy source and destination memory table entry numbers: 000 to 127

- Available Allocation Words

The PT status control area can be allocated to the following PLC areas:

Symbol	C-series	Allocation	CVM1/CV -series	Allocation	CS/CJ-series	Allocation
None	IR Area	○	CIO Area	○	CIO Area	○
H	HR Area	○	---	---	HR Area	Not for Host Link
A	AR Area	○	AR Area	×	AR Area	○
L	LR Area	○	---	---	LR Area (See note 1.)	Not for Host Link
T	TC Area Timer PVs	×	TC Area Timer PVs	×	TC Area Timer PVs	×
TU	---	---	---	---	TC area, Timer Completion Flags	×
C	TC Area Counter PVs	×	TC Area Counter PVs	×	TC Area Counter PVs	×
CU	---	---	---	---	TC area, Counter Completion Flags	×
W	---	---	---	---	WR	Not for Host Link
TK	---	---	---	---	Task Flags	×
D	DM Area	○	DM Area	○	DM Area	○
E	EM Area (See note 2.)	○	EM Area Current bank	Not for Host Link	EM Area Current bank	Not for Host Link
E0_to EC_	---	---	---	---	EM Area EM bank 0 to C	Not for Host Link

○: OK ×: NG



Since the AR area bits of the CVM1/CV series PLCs are allocated to the system, they cannot be used for purposes other than the system use.

- Note**
- (1) LR 00000 to LR 00199 are converted to CIO 01000 to CIO 01199.
  - (2) The EM Area is supported only by the C200HX/HG/HE-(Z)E PLCs.

- 1,2,3...**
1. Use the Support Tool to allocate the PT status control area (PLC to PT) to the PLC memory.
  2. Register the memory table entries for the numerals and character strings to be displayed when creating the screen data by using the Support Tool.
    - To display a character string, use “character display” and specify the character-string memory table entry by using the Support Tool.
    - To display numerals, use “numeral display” and specify the numeral memory table entry by using the Support Tool.
  3. Set the copy source data to the memory table entry when creating the screen data by using the Support Tool.
    - Use “table edit”.
  4. Create a PLC program to write the copy type, copy destination memory table entry number, and copy source memory table entry number to the “copy memory table entry” setting word in the PT status control area.
    - Order for Writing to the PT Status Control Area (PLC to PT)
      - First write the “copy destination memory table entry number”, and then, write the “copy source memory table entry number” to the PT status control area (PLC to PT).
      - The NT20 reads the area sometimes when the PLC is writing the settings. If the “copy source memory table entry number” has been written first and is changed, unexpected memory table entries may possibly be changed.
    - Allocated Words That the NT20 Reads
      - The NT20 reads the allocated words in the PLC for the memory table entries which need to be displayed. Even when a copy source memory table entry is allocated to a PLC word, if its contents are never displayed it will be used only at initialization.
    - Use of the Copy Type
      - Copy will not be executed when the “copy type” is other than “0” or “1”. The memory table entry copy is executed only when the contents of the area are changed. To repeat copying of the same copy source and same copy destination, write a value other than “0” or “1” for the copy type, and then, write a correct value again.
    - Copying a Numeral Memory Table Entry
      - If the display method or the number of registered words include discrepancies, a numeral memory table entry may not be copied and displayed correctly.

### Application Example of Copying of a Character-String Memory Table Entry

This example gives a PLC program to switch the character string display on the screen by using the memory table entry copy operation as the allocated bit is turned ON and OFF.

- Support Tool Settings
  - Allocate the memory as shown below by using the Support Tool.
  - PT status control area allocation: Word 0100

Contents registered to the screen: Character-string memory table entry #4

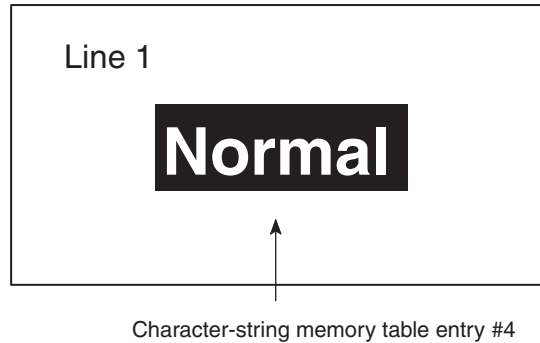

Character-string memory table settings

#	Contents	Number of Character Digits
4	Normal	6 digits
10	Error	6 digits
11	Normal	6 digits

• PLC Ladder Program

Create a PLC ladder program as follows:

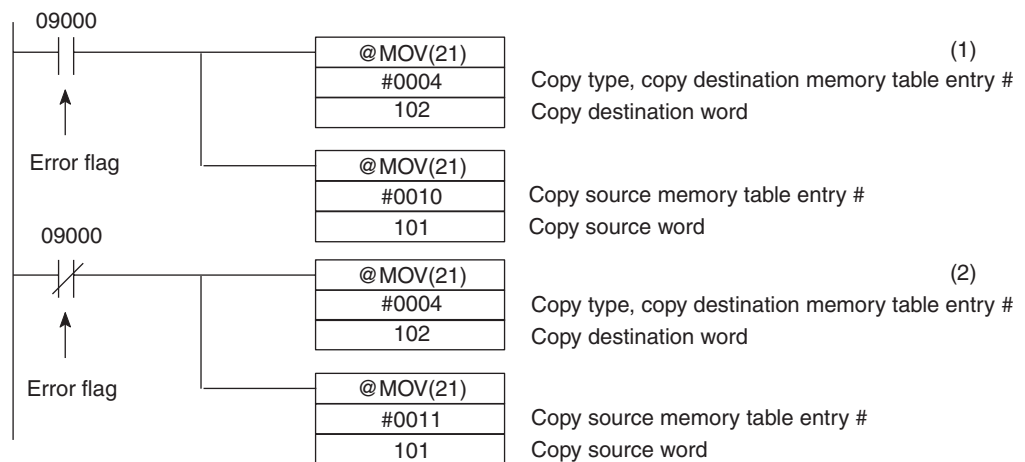

• Program Operation

- 1,2,3...
1. When an error occurs (bit 09000 turns ON), the NT20 displays the message "Error".
  2. When the error is cleared (bit 09000 turns OFF), the NT20 display message reverts to "Normal".

### 5-2-5 Upgrading Bar Graphs (Changing the Contents of Allocated Words)

The following describes the procedure to upgrade the bar graph display on the NT20 by changing the contents of the allocated words.

To change the bar graph display on the NT20, change the contents of the PLC words to which the numeral memory table entries have been allocated.

The bar graph display cannot use hexadecimal numbers. If hexadecimal numbers are set, the bar graph will not be displayed.

By writing a negative number (whose most significant digit is “F”) to the allocated word of a graph set as “Sign display “No””, the graph display will become 0 % and the % display will show “\*\*\* %”.

For the procedure to write numeral values to the allocated words of the numeral memory table entries, refer to 5-2-1 *Displaying the Contents of Allocated Words of Memory Table Entries* (page 180).

For the procedure to change the contents of the numeral memory table entry (PLC words), refer to 5-2-2 *Changing Displayed Numerals or Character Strings (Changing the Contents of Allocated Words ... Direct Specification)* on page 182.

- Available Allocation Words

The numeral memory table entries can be allocated to the following PLC areas:

Symbol	C-series	Allocation	CVM1/CV -series	Allocation	CS/CJ-series	Allocation
None	IR Area	○	CIO Area	○	CIO Area	○
H	HR Area	○	---	---	HR Area	Not for Host Link
A	AR Area	○	AR Area	×	AR Area	○
L	LR Area	○	---	---	LR Area (See note 1.)	Not for Host Link
T	TC Area Timer PVs	△	TC Area Timer PVs	△	TC Area Timer PVs	△
TU	---	---	---	---	TC area, Timer Completion Flags	×
C	TC Area Counter PVs	△	TC Area Counter PVs	Not for Host Link	TC Area Counter PVs	△
CU	---	---	---	---	TC area, Counter Completion Flags	×
W	---	---	---	---	WR	Not for Host Link
TK	---	---	---	---	Task Flags	×
D	DM Area	○	DM Area	○	DM Area	○
E	EM Area (See note 2.)	○	EM Area Current bank	Not for Host Link	EM Area Current bank	Not for Host Link
E0_to EC_	---	---	---	---	EM Area EM bank 0 to C	Not for Host Link

○: OK △: 1 word only ×: NG

Since the AR area bits of the CVM1/CV series PLCs are allocated to the system, they cannot be used for purposes other than the system use.

The range of respective area varies with the type of PLC.

- Note**
- (1) LR 0000 to LR 00199 are converted to CIO 01000 to CIO 01199.
  - (2) The EM Area is supported only by the C200HX/HG/HE-(Z)E PLCs.

## 5-3 Lamps, Touch Switches, Numeral Setting

### 5-3-1 Allocation Bits and Display of Lamps

Lamps are controlled by allocating them to the PLC bits. Set the area and bit number.

- Available Allocation Bits

The lamps can be allocated to the following PLC areas:

Symbol	C-series	Allocation	CVM1/CV -series	Allocation	CS/CJ-series	Allocation
None	IR Area	○	CIO Area	○	CIO Area	○
H	HR Area	○	---	---	HR Area	Not for Host Link
A	AR Area	○	AR Area	×	AR Area	○
L	LR Area	○	---	---	LR Area (See note 1.)	Not for Host Link
T	TC Area Timer PVs	×	TC Area Timer PVs	×	TC Area Timer PVs	×
TU	---	---	---	---	TC area, Timer Completion Flags	×
C	TC Area Counter PVs	×	TC Area Counter PVs	×	TC Area Counter PVs	×
CU	---	---	---	---	TC area, Counter Completion Flags	×
W	---	---	---	---	WR	Not for Host Link
TK	---	---	---	---	Task Flags	×
D	DM Area	○	DM Area	○	DM Area	○
E	EM Area (See note 2.)	○	EM Area Current bank	Not for Host Link	EM Area Current bank	Not for Host Link
E0_to EC_	---	---	---	---	EM Area EM bank 0 to C	Not for Host Link

○: OK ×: NG

Since the AR area bits of the CVM1/CV series PLCs are allocated to the system, they cannot be used for purposes other than the system use.

The range of respective area varies with the type of PLC.

**Note** (1) LR 00000 to LR 00199 are converted to CIO 01000 to CIO 01199.

(2) The EM Area is supported only by the C200HX/HG/HE-(Z)E PLCs.

To set the data memory (DM), specify the word number and then the bit number (00 to 15).

### 5-3-2 Turning ON (Lit) and OFF (Unlit) the Lamps (Changing the Contents of Allocated Bits)

The following describes the procedure to change the lamp display status on the NT20 by changing the contents of the allocated bits.

To change the lamp display status on the NT20, turn ON and OFF the lamp control bit allocated in the PLC.

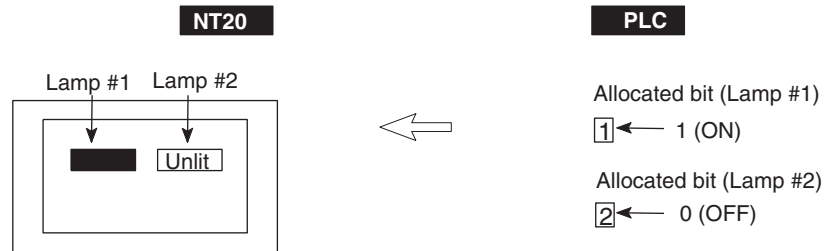

The lamp bit indicates the lamp status as follows:

0 (OFF): Unlit

1 (ON): Lit (reverse display) or flashing

- 1,2,3...**
1. Use the Support Tool to set the PLC memory area where the lamp bit is to be allocated to.
  2. Register the lamps to the screen when creating the screen data by using the Support Tool.
  3. Create a PLC program to turn ON/OFF the lamp bit.

Use the Support Tool to set the lamp display attributes whether the lamp is lit or flashing when the lamp control bit is turned ON.

#### Application Example to Make the Lamp Light or Flash

This example gives a procedure to control the bits to move a robot arm and turning the lamps ON and OFF.

- Support Tool Settings

Allocate the memory as shown below by using the Support Tool.

Lamp #0: Word 000200 (output bit to raise robot arm), guide display message "UP"

Lamp #1: Word 000201 (output bit to lower robot arm), guide display message "DOWN"

Lamp #2: Word 000202 (output bit to rotate robot arm counterclockwise), guide display message "C/CLOCK"

Lamp #3: Word 000203 (output bit to rotate robot arm clockwise), guide display message "CLOCK"

Lamp #4: Word 000204 (output bit to clamp rotate robot arm), guide display message "CLAMP"

Lamp #5: Word 000205 (output bit to unclamp rotate robot arm), guide display message "UNCLAMP"

Contents registered to the screen: Lamp #0 to #5

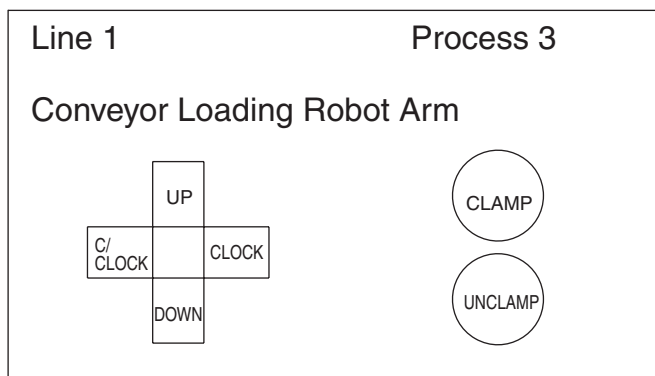

- Raise: Lamp#0
- Lower: Lamp#1
- Counterclockwise: Lamp#2
- Clockwise: Lamp#3
- Clamp: Lamp#4
- Unclamp: Lamp#5

- PLC Ladder Program
 

No PLC ladder program is required to control the NT20. Only a program to control the robot arm movements is required.
- NT20 Operation
 

When the ladder program to control the robot arm is executed, the lamps on the NT20 screen turn ON and OFF in synchronization with the robot arm movement.

For example, lamp #0 lights when the robot arm moves up and goes out when it stops moving up.

### 5-3-3 Allocated Bits and Display of Touch Switches

#### Method for PLC Notification and NT20 Control

Two types of bit can be allocated to touch switches: notify bits - which serve to notify status to the PLC - and control bits, lamp bit, which control the lighting (flashing) of the touch switches. (For other types of function, only lamp bits can be allocated.) When a touch switch is pressed the notify bit status changes and, when the lamp bit is ON, the touch switch lights (or flashes).

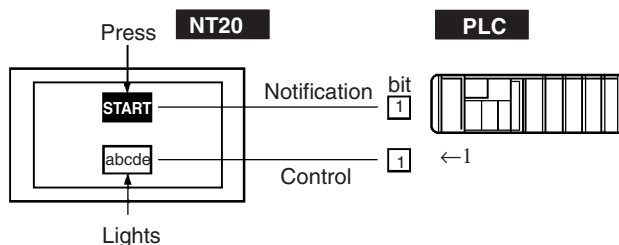

In order to notify the PLC of the status of a touch switch, the touch switch must be allocated to a specified PLC bit so that it can be managed. Designate the area and bit number.

To use touch switches for notification to the PLC, the following settings must be made using the Support Tool: "touch switch" – "bit setting" – "notify bit".

- Types of Notification Operation
 

When using Ver. 5 of the direct connection function, the notification operation when the touch switch is pressed can be selected from the following four types (with Ver. 4 direct connection, the type is fixed as "momentary"):

  - Momentary
 

When the touch switch is pressed the bit comes ON; when it is released the bit goes OFF.
  - Alternate

Each time the touch switch is pressed, the bit status changes from ON to OFF or OFF to ON.

- Set

When the touch switch is pressed, the bit comes ON and remains ON even if the switch is pressed again.

- Reset

When the touch switch is pressed, the bit goes OFF and remains OFF even if the switch is pressed again.

- Notification Operations

The touch switch notification operations are as follows:

Type of Notification Operation	When Using Host Link or NT Link with DM Area	When Using C200H Direct Communications or NT Link with other than DM Area
Momentary	(1) Notification in word units (other bits go OFF)	(3) Notification in bit units
Alternate Set Reset	(2) Notification in word units (however, the word contents are read on display and notification is based on this reading)	(4) Notification in bit units

When using touch switch input notification, note the following points:

- In the case of (1), the other bits in the same word as the notification bit are turned OFF by the notification operation.
- In the case of (2), notification is executed on the basis of the contents of the word before display, which means that the other bits are not rewritten. However, if the word contents are changed at the PLC, they will be rewritten based on the contents before display.
- If the screen is switched while a momentary key is being pressed, the touch switch itself disappears, so the status "OFF" is indicated. In the case of (1) this means that the other bits in the word will also be turned OFF.
- When using the host link, or NT link with the DM area, do not allocate momentary touch switches and other types of touch switch to the same word, since the notification operations are different.

In the case of (3) and (4), the notification operation has no influence on the other bits in the word.

- Possible Bit Allocations

Notify bits and lamp bits for touch switches can be allocated to the areas of the PLC memory listed in the following table.

Symbol	C-series	Allocation	CVM1/CV -series	Allocation	CS/CJ-series	Allocation
None	IR Area	○	CIO Area	○	CIO Area	○
H	HR Area	○	---	---	HR Area	Not for Host Link
A	AR Area	○	AR Area	×	AR Area	○
L	LR Area	○	---	---	LR Area (See note 1.)	Not for Host Link
T	TC Area Timer PVs	×	TC Area Timer PVs	×	TC Area Timer PVs	×
TU	---	---	---	---	TC area, Timer Completion Flags	×

C	TC Area Counter PVs	×	TC Area Counter PVs	×	TC Area Counter PVs	×
CU	---	---	---	---	TC area, Counter Completion Flags	×
W	---	---	---	---	WR	Not for Host Link
TK	---	---	---	---	Task Flags	×
D	DM Area	○	DM Area	○	DM Area	○
E	EM Area (See note 2.)	○	EM Area Current bank	Not for Host Link	EM Area Current bank	Not for Host Link
E0_to EC_	---	---	---	---	EM Area EM bank 0 to C	Not for Host Link

○: OK ×: NG

Since all the CVM1/CV-series AR area bits are allocated to the system, they cannot be used for applications not related to the system.

The range of each memory area differs according to the PLC type.

- Note**
- (1) LR 00000 to LR 00199 are converted to CIO 01000 to CIO 01199.
  - (2) The EM Area is supported only by the C200HX/HG/HE-(Z)E PLCs.

When making a data memory (DM) specification, specify the bit number (00 to 15) following the word number.

### 5-3-4 Lit (Flashing) and Unlit Touch Switch Status (Changing the Status of Allocated Bits)

This section describes how to change the status of allocated bits and thereby the status of the touch switches displayed by the NT20.

The status of touch switches displayed by the NT20 is changed by switching the control bits allocated in the PLC memory ON and OFF.

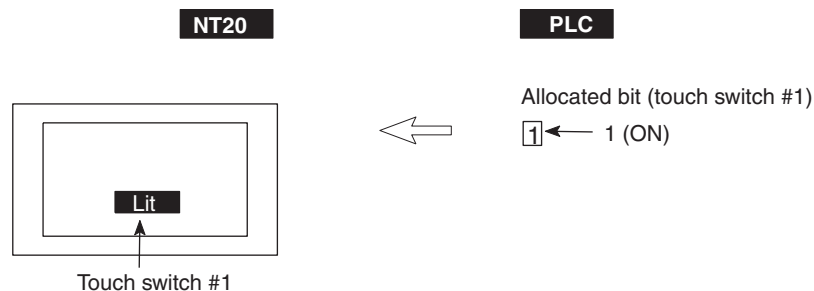

The status of the lamp bit reflects the touch switch status, as follows:

- 0 (OFF): Unlit
- 1 (ON): Lit (inverse display) or flashing

- 1,2,3...**
1. Use the Support Tool to allocate the touch switch lamp bits to the PLC memory.
  2. When creating the screen data using the Support Tool, register the touch switch for a screen.
  3. Create the PLC program to switch the lamp bit of the touch switch ON and OFF.  
Set whether the lamp lights continuously or flashes when the bit comes ON by setting the touch switch display attribute with the Support Tool.



### 5-3-5 Notifying the Host That a Switch Has Been Pressed (Determining Touch Switch Status)

This section describes how the status of a touch switch (whether it has been pressed or not) is ascertained.

With the NT20, when a touch switch is pressed, the notify bit allocated to that touch switch in the PLC memory is automatically updated.

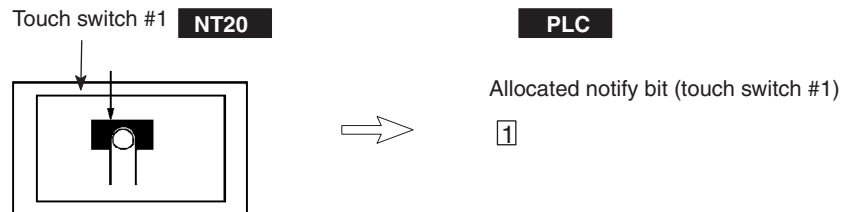

Depending on the set operation type, the status of the allocated bit for touch switch status notification will be controlled in one of the following ways:

**Momentary:** 0 (OFF) ... Not pressed  
1 (ON) ... Pressed

**Alternate:** The allocated bit is switched to 1 (ON) if currently 0, and to 0 (OFF) if currently 1.

**Set:** The allocated notify bit is forcibly switched to 1 (ON).

**Reset:** The allocated notify bit is forcibly switched to 0 (OFF).

In order to determine the status of a touch switch, the status of the touch switch notification bit allocated to it is determined.

The touch switch notify bits can be allocated to the following areas of the PLC memory.

Symbol	C-series	Allocation	CVM1/CV-series	Allocation	CS/CJ-series	Allocation
None	IR Area	○	CIO Area	○	CIO Area	○
H	HR Area	○	---	---	HR Area	Not for Host Link
A	AR Area	○	AR Area	×	AR Area	○
L	LR Area	○	---	---	LR Area (See note 1.)	Not for Host Link
T	TC Area Timer PVs	×	TC Area Timer PVs	×	TC Area Timer PVs	×
TU	---	---	---	---	TC area, Timer Completion Flags	×
C	TC Area Counter PVs	×	TC Area Counter PVs	×	TC Area Counter PVs	×
CU	---	---	---	---	TC area, Counter Completion Flags	×
W	---	---	---	---	WR	Not for Host Link
TK	---	---	---	---	Task Flags	×
D	DM Area	○	DM Area	○	DM Area	○
E	EM Area (See note 2.)	○	EM Area Current bank	Not for Host Link	EM Area Current bank	Not for Host Link
E0_to EC_	---	---	---	---	EM Area EM bank 0 to C	Not for Host Link

○: OK ×: NG

Since all the CVM1/CV-series AR area bits are allocated to the system, they cannot be used for applications not related to the system.

The range of each memory area differs according to the PLC type.

- Note**
- (1) LR 00000 to LR 00199 are converted to CIO 01000 to CIO 01199.
  - (2) The EM Area is supported only by the C200HX/HG/HE-(Z)E PLCs.

When making a data memory (DM) specification, specify the bit number (00 to 15) following the word number.

- 1,2,3...**
1. Use the Support Tool to allocate the touch switch notify bits to the PLC memory.
  2. When creating the screen data using the Support Tool, register the touch switch for a screen.
  3. Create a PLC program to determine whether the touch switch notify bit is ON or OFF.

The touch switch notification operations are as follows:

Type of Notification Operation	When Using Host Link or NT Link with DM Area	When Using C200H Direct Communications or NT Link with other than DM Area
Momentary	(1) Notification in word units (other bits go OFF)	(3) Notification in bit units
Alternate Set Reset	(2) Notification in word units (however, the word contents are read on display and notification is based on this reading)	(4) Notification in bit units

When using touch switch input notification, note the following points:

- In the case of (1), the other bits in the same word as the notification bit are turned OFF by the notification operation.

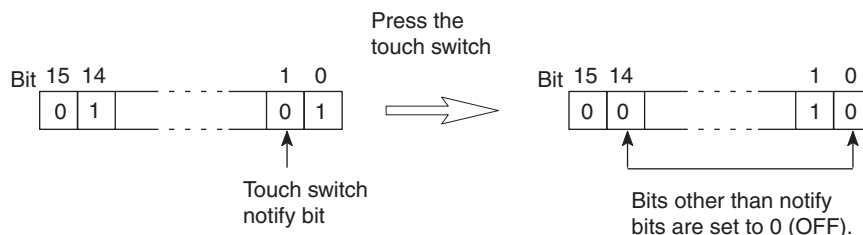

- In the case of (2), notification is executed on the basis of the contents of the word before display, which means that the other bits are not rewritten. However, if the word contents are changed at the PLC, they will be rewritten based on the contents before display.
- If the screen is switched while a momentary key is being pressed, the touch switch itself disappears, so the status "OFF" is indicated. In the case of (1) this means that the other bits in the word will also be turned OFF.
- When using the host link, or NT link with the DM area, do not allocate momentary touch switches and other types of touch switch to the same word, since the notification operations are different.

In the case of (3) and (4), the notification operation has no influence on the other bits in the word.

**Example of Determination of Touch Switch Status**

This example uses the touch switches as normal switches (bits) in order to use the NT20 as an operating panel.

• Support Tool Settings

Make the following settings using the Support Tool.

Touch switch #10:

Function "Notify Bit"

Display attribute "Light"

Control bit 05000 (Run flag) ... Guide message: "RUN"

Notify bit 06000

Touch switch #11:

Function "Notify Bit"

Display attribute "Light"

Control bit 05000 (Stop flag) ... Guide message: "STOP"

Notify bit 06001

Data registered for the screen: touch switch #10, touch switch #11

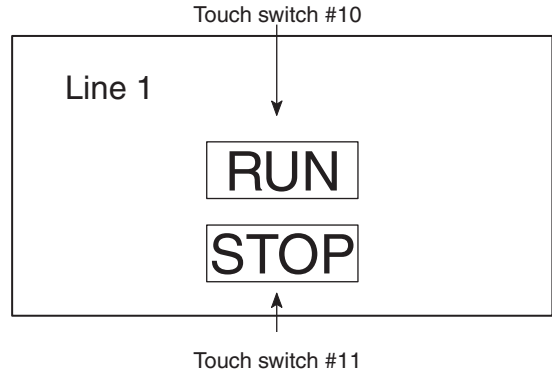

• PLC Program

Create the following ladder program.

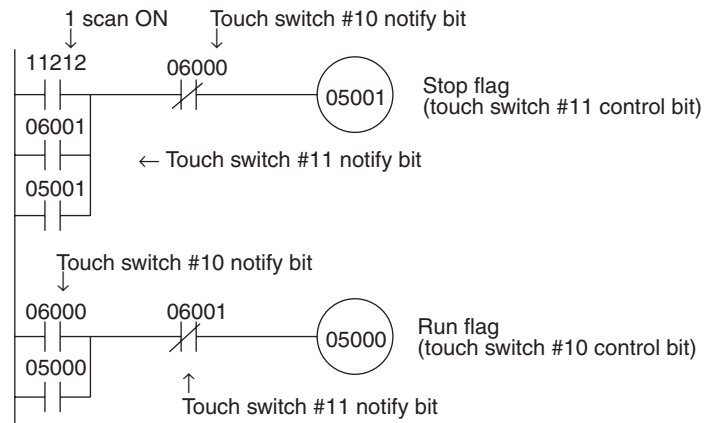

• Program Operation

The operation when the program is executed is presented below.

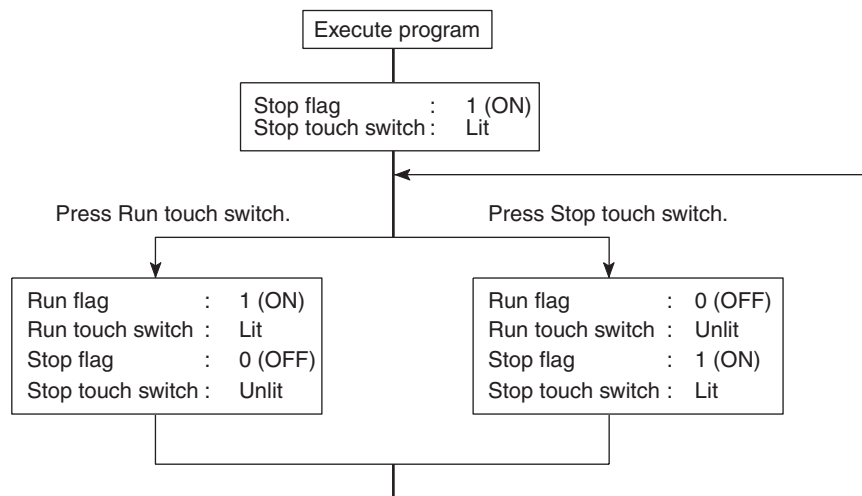

### 5-3-6 Notification of Numbers to the PLC

The following describes how the numerical data input at the NT20 by using the numeral setting function is ascertained by the PLC.

In order to determine when numerical data has been input at the NT20, the numeral setting strobe flag in the PT status notify area is used. In order to determine the upgraded numeral memory table entry number, the “upgraded memory table entry” in the PT status notify area is used.

When numerical data is input at the NT20, this is automatically indicated in the PT status notify area (PT → PLC) allocated in the PLC memory as follows.

Notification of upgrade: PT status numeral setting strobe flag turned ON (1)

Upgraded numeral table entry number: Stored in the “upgraded memory table entry”

When the PLC reads the “upgraded memory table entry” at the leading edge of the numeral setting strobe flag, it determines the numeral memory table entry number in which the numerical data that was changed at the NT20 is stored.

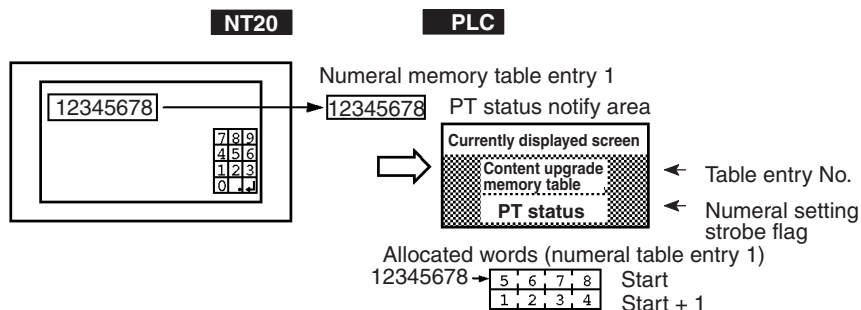

Upgraded Memory Table Entry in the PT Status Notify Area and PT Status

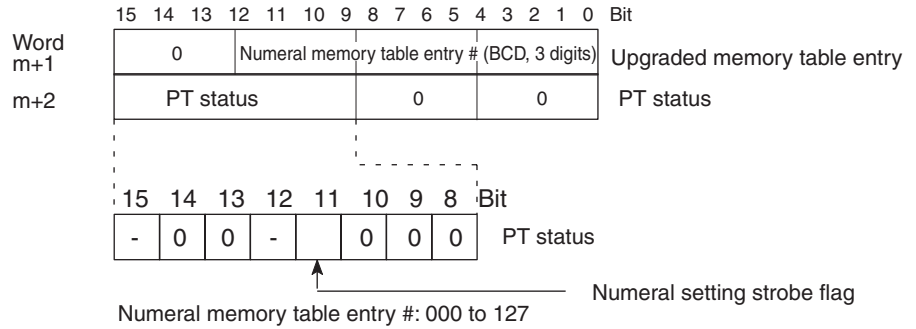

Data is written to the upgraded memory table entry as three digits of BCD (binary coded decimal) data.

When the numeral setting strobe flag bit has been updated in the PLC it returns to the OFF (0) status.

For details on the method for storing a number in the word allocated for the numeral memory table entry, refer to 5-2-1 *Displaying the Contents of Allocated Words of Memory Table Entries* on page 180.

• Restrictions on Allocating Words

The PT status notify area can be allocated to the PLC memory areas listed in the following table.

Symbol	C-series	Allocation	CVM1/CV-series	Allocation	CS/CJ-series	Allocation
None	IR Area	○	CIO Area	○	CIO Area	○
H	HR Area	○	---	---	HR Area	Not for Host Link
A	AR Area	○	AR Area	×	AR Area	○
L	LR Area	○	---	---	LR Area (See note 1.)	Not for Host Link
T	TC Area Timer PVs	×	TC Area Timer PVs	×	TC Area Timer PVs	×
TU	---	---	---	---	TC area, Timer Completion Flags	×
C	TC Area Counter PVs	×	TC Area Counter PVs	×	TC Area Counter PVs	×
CU	---	---	---	---	TC area, Counter Completion Flags	×
W	---	---	---	---	WR	Not for Host Link
TK	---	---	---	---	Task Flags	×
D	DM Area	○	DM Area	○	DM Area	○
E	EM Area (See note 2.)	○	EM Area Current bank	Not for Host Link	EM Area Current bank	Not for Host Link
E0_to EC_	---	---	---	---	EM Area EM bank 0 to C	Not for Host Link

○: OK ×: NG

Since all the CVM1/CV-series AR area bits are allocated to the system, they cannot be used for applications not related to the system.

The range of each memory area differs according to the PLC type.

- Note**
- (1) LR 00000 to LR 00199 are converted to CIO 01000 to CIO 01199.
  - (2) The EM Area is supported only by the C200HX/HG/HE-(Z)E PLCs.

- 1,2,3...**
1. Use the Support Tool to allocate the PT status notify area (PT → PLC) to the PLC memory.
  2. Using the Support Tool, create a numeral setting screen and allocate the numeral memory table entry to the PLC memory.
  3. Create a PLC program for reading the “upgraded memory table entry” in the PT status notify area when the numeral setting strobe flag in the PT status notify area comes ON (1).
  4. Read the allocated word for the numeral memory table entry number read in step 3.

**Example of Reading a Numeral Memory Table Entry into Which a Numerical Value Has Been Input**

This example shows the reading of the numeral memory table entry number after a value has been changed by inputting numerical data at the NT20.

• Setting at the Support Tool

Make the following settings using the Support Tool.

Allocated word for the PT status notify area: 0110

Numeral memory table entry No.3: DM 0005 (saved word: One)

Numeral memory table entry No.4: DM 0006 (saved word: One)

Data registered for the screens:

Numeral setting 1 ... Reference table “numeral memory table entry #3”

Numeral setting 2 ... Reference table “numeral memory table entry #4”

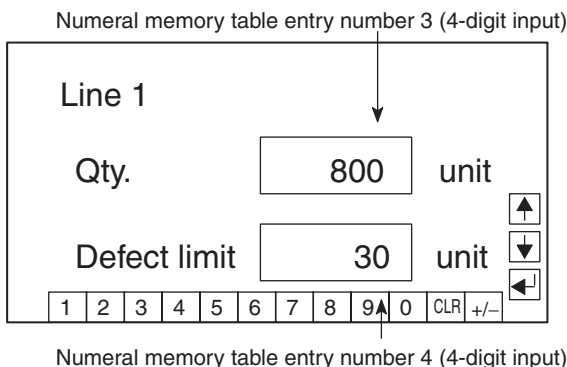

• PLC Program

Create the following PLC ladder program.

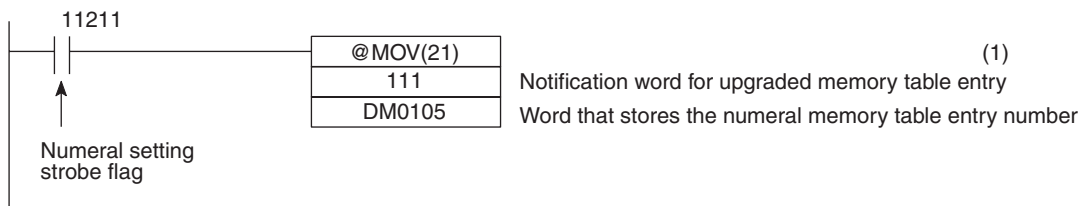

• Program Operation

- 1,2,3...**
1. When the numeral setting strobe flag (bit 11211) comes ON (1), the contents of word 0111 (the word where the upgraded memory table entry is located) are transferred to DM 0105. The number of the numeral memory table entry that contains the upgraded data is stored in DM 0105 (in this case it is 0003 or 0004).

If the numeral memory table entry is allocated to a PLC word, the value input to it can be read easily by referring to the allocated word.

In this case, the contents of numeral memory table entry #3 is stored in DM 0005 and the contents of numeral table entry #4 is stored in DM 0006.

### 5-4 NT20 Status Control

The status of the NT20 can be controlled from the PLC by writing control data to the “PT status control bits” of the PT status control area allocated in the PLC memory.

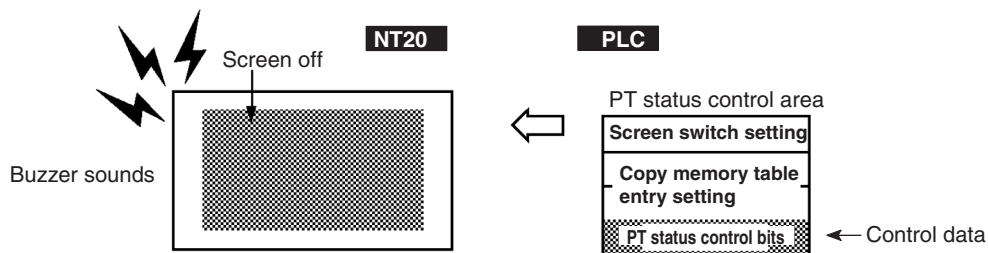

#### 5-4-1 Controllable NT20 Functions

PT Status Control Bits of the PT Status Control Area

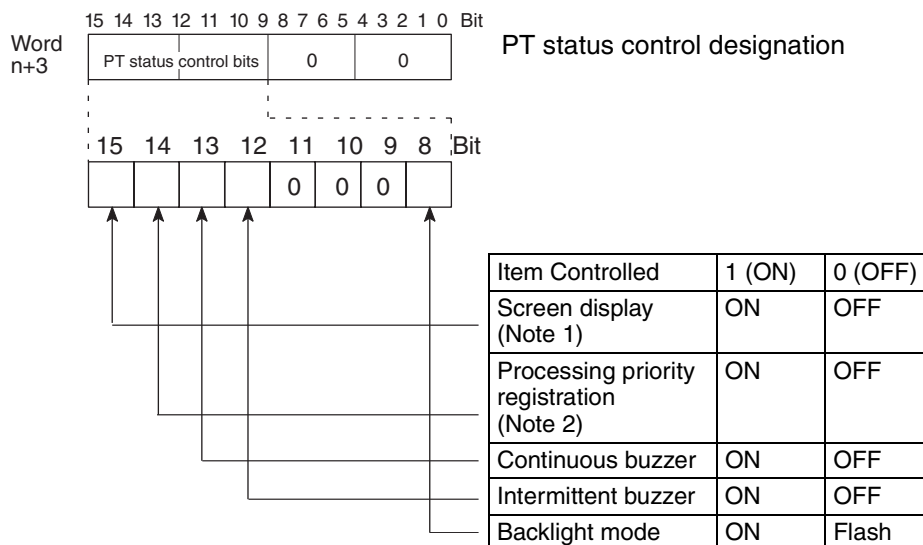

Note 1: The backlighting is on when the screen display bit is set to ON and off when the screen display bit is set to OFF.

Note 2: Priority registration is only valid when NT link (1:N) is set.

The PLC status control bits remain unchanged if the NT20 status is changed with the screen attributes or memory switches, which means that the status of the PT status control bits does not match the actual status of the NT20. For example, the buzzer may sound even though the setting for continuous buzzer bit 13 is “OFF”.

In this kind of case, control the NT20 by using the PT status control bits.

- Screen Display (Bit 15)

The screen display bit is used to display and clear the screen to prevent “burn-in” on the CRT. Set bit 15 to 0 (OFF) to clear the screen. The backlight will also go OFF at the same time.

When the screen has been cleared, the last displayed screen can be re-displayed either by turning Bit 15 ON, or by pressing a touch switch. The backlight will also light at the same time.



Note that if the screen is OFF by the backlight OFF or EL screen OFF function with Bit 15 ON (1), turn Bit 15 OFF (0) once and then turn it back ON (1) to redisplay the screen.

**Note** Instead of turning Bit 15 ON, a screen can be displayed by specifying its screen number. For details on screen switching, refer to 5-1-4 *Switching the Screen Display* on page 172.

- Priority Registration for Processing (1:N NT Link Only) (Bit 14)

It is possible to register one of the multiple PTs connected by the 1:N NT link method to have processing priority. The PT for which bit 14 is set ON (1) is given priority over the other PTs and has a higher response speed for display, touch switches, etc.

When bit 14 is turned OFF (0), this registration is canceled and the normal response speed is reinstated. If priority registration is set for more than one PT, the one for which the registration was made last will have priority.

By monitoring C200HX/HG/HE words, the unit number of the PT for which priority registration has been set can be confirmed. For details on the monitoring operation at the PLC, refer to the manual for the PLC used.

#### Connection to RS-232C Port of C200HX/HG/HE

Word	Bit	Function
CIO 265 (standard port)	0	Unit No.0 Communications in progress flag, ON when connected
	1	Unit No.1 Communications in progress flag, ON when connected
	2	Unit No.2 Communications in progress flag, ON when connected
CIO 284 (port A) (See note.)	3	Unit No.3 Communications in progress flag, ON when connected
	4	Unit No.4 Communications in progress flag, ON when connected
	5	Unit No.5 Communications in progress flag, ON when connected
CIO 285 (port B) (See note.)	6	Unit No.6 Communications in progress flag, ON when connected
	7	Unit No.7 Communications in progress flag, ON when connected
	8	Unit No.0 Priority registration lamp, ON when registered
	9	Unit No.1 Priority registration lamp, ON when registered
	10	Unit No.2 Priority registration lamp, ON when registered
	11	Unit No.3 Priority registration lamp, ON when registered
	12	Unit No.4 Priority registration lamp, ON when registered
	13	Unit No.5 Priority registration lamp, ON when registered
	14	Unit No.6 Priority registration lamp, ON when registered
	15	Unit No.7 Priority registration lamp, ON when registered

**Note** This is the port of the communications port.

- Continuous Buzzer (Bit 13) and Intermittent Buzzer (Bit 12)  
 In the case of both buzzers, when the respective bit is ON the buzzer sounds and when it is OFF the buzzer does not sound.  
 The “continuous buzzer” sounds continuously without interruption.  
 The “intermittent buzzer” sounds for 0.5 seconds at 0.5 second intervals.  
 If both Bit 13 and Bit 12 are turned ON simultaneously, Bit 13 takes priority and the continuous buzzer is selected.

Another way to stop a buzzer sounding is to use a touch switch to which the buzzer stop attribute function is allocated.

Whether or not the buzzer actually sounds also depends on the setting of the “buzzer” memory switch of the NT20. For details on this setting, refer to 3-8-2 *Using the Buzzer* on page 107.

Besides using PT status control bit operations, the buzzer status can also be controlled by the screen attributes. The screen attributes are set by using the Support Tool. The functions that can be set using the screen attributes are the following:

Buzzer attribute: Set whether or not the buzzer will sound when the screen is displayed and, if it sounds, the type of buzzer.

- Backlight Mode (Bit 8)  
 If bit 8 is turned ON when the screen is displayed (bit 15 = ON), the screen is made to flash using the backlight. When bit 8 is turned OFF, normal display is resumed.  
 When the screen is not displayed (bit 15 = OFF), the backlight mode is invalid.

It is possible to use NT20 switch settings to make the backlight go off automatically after a set time during which there have been no operations.

Besides using PT status control bit operations, the backlight status can also be controlled by the screen attributes. The screen attributes are set by using the Support Tool. The functions that can be set using the screen attributes are the following:

Backlight: Set whether the backlight will be continuously or intermittently lit when the screen is displayed.

### 5-4-2 How to Control NT20 Functions

This section describes how to control the functions of the NT20.

- Restrictions on Allocating Words  
 The PT status control area (PLC → PT) can be allocated to the PLC memory areas listed in the following table.

Symbol	C-series	Allocation	CVM1/CV -series	Allocation	CS/CJ-series	Allocation
None	IR Area	○	CIO Area	○	CIO Area	○
H	HR Area	○	---	---	HR Area	Not for Host Link
A	AR Area	○	AR Area	×	AR Area	○
L	LR Area	○	---	---	LR Area (See note 1.)	Not for Host Link
T	TC Area Timer PVs	×	TC Area Timer PVs	×	TC Area Timer PVs	×

TU	---	---	---	---	TC area, Timer Completion Flags	×
C	TC Area Counter PVs	×	TC Area Counter PVs	×	TC Area Counter PVs	×
CU	---	---	---	---	TC area, Counter Completion Flags	×
W	---	---	---	---	WR	Not for Host Link
TK	---	---	---	---	Task Flags	×
D	DM Area	○	DM Area	○	DM Area	○
E	EM Area (See note 2.)	○	EM Area Current bank	Not for Host Link	EM Area Current bank	Not for Host Link
E0_to EC_	---	---	---	---	EM Area EM bank 0 to C	Not for Host Link

○: OK ×: NG

Since all the CVM1/CV-series AR area bits are allocated to the system, they cannot be used for applications not related to the system.

The range of each memory area differs according to the PLC type.

**Note**

- (1) LR 0000 to LR 00199 are converted to CIO 01000 to CIO 01199.
- (2) The EM Area is supported only by the C200HX/HG/HE-(Z)E PLCs.

**1,2,3...**

1. Use the Support Tool to set the area at the PLC used for allocation of the PT status control area (PLC → PT).
2. Write a PLC program for writing the control data into the “PT status control bit” of the PT status control area.

- Timing for Control of the PT Status Control Bit

The PT status control bit is not read when the NT20 is started up. It is read, and control executed, only when the contents of the PT status control bit are read for the first time after the NT20 is started up.

Since NT20 status control is executed when the bit corresponding to the PT status control bit changes, in order to perform the same control again the corresponding bit must be specified again.

**Example of Use of PT Status Control Bit**

The example below explains how operation with the PT status control bit can be used to use the NT20 like a warning lamp.

- Setting with the Support Tool

Make the following setting with the Support Tool.

Allocated word for PT status control area: Word 0100

- PLC Program

Create the PLC ladder program as follows.

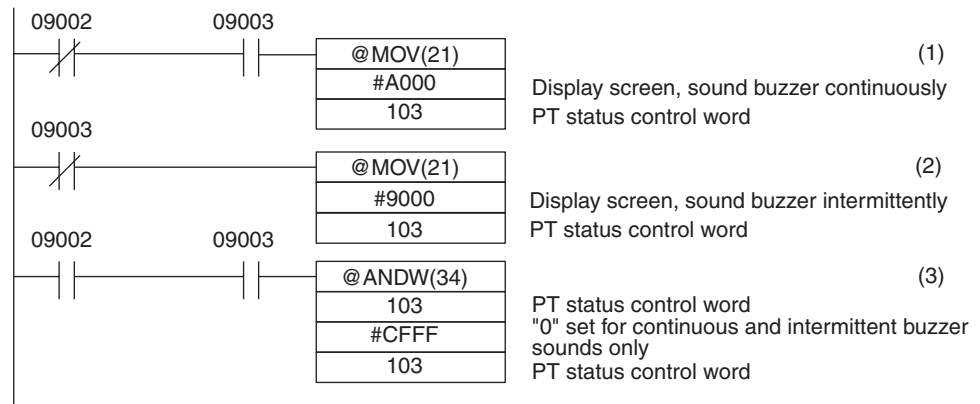

• Program Operation

- 1,2,3...**
1. The PT status control bits are set as shown below when bit 09002 turns OFF. This command block is not executed until bit 09003 is ON.
 

Screen display (bit 15)	1 (ON)
Continuous buzzer (bit 13)	1 (ON)

The NT20 continuous buzzer sounds.
  2. The PT status control bits are set as shown below when bit 09003 turns OFF.
 

Screen display (bit 15)	1 (ON)
Intermittent buzzer (bit 12)	1 (ON)

The NT20 intermittent buzzer sounds
  3. The PT status control bits are set as shown below when both bits 09002 and 09003 turn ON.
 

Continuous buzzer (bit 13)	0 (OFF)
Intermittent buzzer (bit 12)	0 (OFF)

The NT20 buzzer stops.

## 5-5 Notification of the Operating Status to the PLC (Determining the NT20 Operating Status)

The status (operating status, etc.) of the NT20 can be determined from the PLC by reading the “PT status” word in the PT status notify area allocated in the PLC memory.

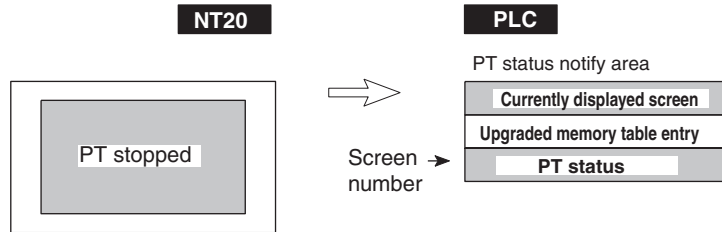

### 5-5-1 Ascertainable NT20 Status (Notified Operating Status)

PT Status Notification Bits of the PT Status Notify Area

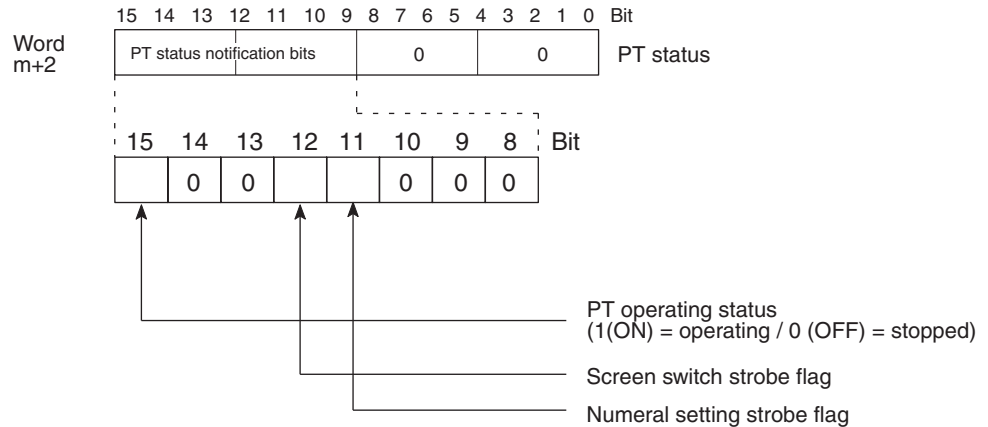

**Caution** Make the settings so that the PT control area and PT status notify area do not overlap.

- PT Operating Status (Bit 15)

When the NT20 is in the RUN mode this bit is set to ON (1). In other modes and while the system menu is displayed it is OFF (0). When this bit is OFF allocated bits and words cannot be read or written to.

During the run mode, ON (1) is periodically written into this bit. In order to check whether the NT20 is operating normally or not, write OFF (0) to this bit: if it is ON (1) 30 seconds later the NT20 is running, and if it is OFF (0), the NT20 is stopped.

**Caution** To ensure system safety, be sure to periodically read the PT operating status bit from the host in order to ensure that the PT is always operating normally.

- Screen Switch Strobe Flag (Bit 12)  
When the screen displayed on the NT20 is switched by a designation from the PLC or by the standalone function, the screen switch strobe flag comes ON (1). On notification to the PLC, it returns to the OFF (0) status.  
For details on how the screen switch strobe flag is used, refer to 5-1-5 *Notifying the PLC of the Display Screen (to Display the Number of Currently Displayed Screen)* on page 174.
- Numeral Setting Strobe Flag (Bit 11)  
When numerical data is input to a numeral memory table entry using the NT20 numeral setting function, the numeral setting strobe flag comes ON (1). On notification to the PLC, it returns to the OFF (0) status.  
For details on how the numeral setting strobe flag is used, refer to 5-3-6 *Notification of Numbers to the PLC* page 199.

## 5-5-2 Reading the NT20 Operating Status

This section explains how to determine the status of the NT20, and ascertain its operating status.

To ascertain the operating status of the NT20, “PT status” is used.

The NT20 automatically notifies the PLC of information such as the operating status in the PT status word of the PT status notify area (PT → PLC) allocated in PLC memory as shown below.

Notification of operation mode: PT operating status  
 Notification of screen switching: Screen switch strobe flag  
 Notification of numerical data upgrade: Numeral setting strobe flag

- Restrictions on Allocating Words

The PT status notify area (PT → PLC) can be allocated to the PLC memory areas listed in the following table.

Symbol	C-series	Allocation	CVM1/CV-series	Allocation	CS/CJ-series	Allocation
None	IR Area	○	CIO Area	○	CIO Area	○
H	HR Area	○	---	---	HR Area	Not for Host Link
A	AR Area	○	AR Area	×	AR Area	○
L	LR Area	○	---	---	LR Area (See note 1.)	Not for Host Link
T	TC Area Timer PVs	×	TC Area Timer PVs	×	TC Area Timer PVs	×
TU	---	---	---	---	TC area, Timer Completion Flags	×
C	TC Area Counter PVs	×	TC Area Counter PVs	×	TC Area Counter PVs	×
CU	---	---	---	---	TC area, Counter Completion Flags	×
W	---	---	---	---	WR	Not for Host Link
TK	---	---	---	---	Task Flags	×
D	DM Area	○	DM Area	○	DM Area	○
E	EM Area (See note 2.)	○	EM Area Current bank	Not for Host Link	EM Area Current bank	Not for Host Link
E0_to EC_	---	---	---	---	EM Area EM bank 0 to C	Not for Host Link

○: OK ×: NG

Since all the CVM1/CV-series AR area bits are allocated to the system, they cannot be used for applications not related to the system.

The range of each memory area differs according to the PLC type.

- Note**
- (1) LR 00000 to LR 00199 are converted to CIO 01000 to CIO 01199.
  - (2) The EM Area is supported only by the C200HX/HG/HE-(Z)E PLCs.

- 1,2,3...**
1. Use the Support Tool to allocate the PT status notify area (PT → PLC) to the PLC memory.
  2. Write a PLC program to read the “PT status” word of the PT status notify area and check each bit status.

• Timing of PT Status Notify Bit Notification

The contents of the PT status notify area (PT → PLC) are written to the PLC whenever the status of the NT20 changes during operation.

**Example of PT Status Notify Bit Application**

In the example below, the status of the NT20 is checked by PT status notify bit notification.

• Settings with the Support Tool

Make the following setting with the Support Tool.

Allocated word for PT status notify area: Word 0110

• PLC Program

Create the following PLC ladder program.

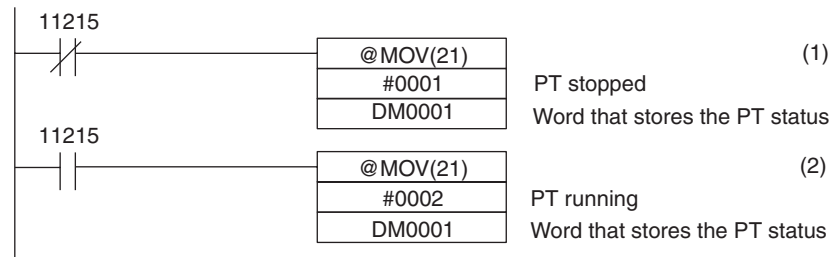

• Program Operation

- 1,2,3...**
1. When the PT operating status (bit 11215) is OFF (0), “1” (PT stopped) is stored in DM0001.
  2. When the PT operating status (bit 11215) is ON (1), “2” (PT running) is stored in DM0001.

# SECTION 6

## Using RS-232C Communications

This section describes how to carry out communications via the RS-232C interface used with the NT20-ST128, focusing on the commands.

6-1	Table of Commands . . . . .	212
6-2	RS-232C Communications . . . . .	213
6-2-1	Communications Procedure . . . . .	213
6-2-2	Precautions . . . . .	214
6-3	Screen Display . . . . .	216
6-4	Memory Tables . . . . .	218
6-5	Lamps, Touch Switches, Numeral Setting . . . . .	221
6-5-1	Notification and Control of Touch Switches . . . . .	221
6-5-2	Notification of Numeral Setting Input and Touch Switch Status . . . . .	224
6-6	Controlling the NT20 Status . . . . .	227
6-7	Terminal Commands . . . . .	229
6-8	Key to Programs . . . . .	234
6-8-1	Use of Programs . . . . .	234



## 6-1 Table of Commands

### Operating Commands

Type	Command	Name	Page
Screen control	[ESC] 0	Display Specified Screen.	216
	[ESC] X	Request Screen Number.	216
Memory table operation	[ESC] B	Write Character-string Memory Table.	218
	[ESC] C	4-digit Write Numeral Memory Table	219
	[ESC] D	8-digit Write Numeral Memory Table	219
	[ESC] /	Copy Memory Table.	220
Lamp and Touch Switch Display	[ESC] K	Lamp and Touch Switch Display (Bit Specification)	223
	[ESC] Q	Lamp and Touch Switch Display (Number Specification)	223
	[ESC] R	Lamp and Touch Switch Display Status Enquiry	224
Touch Switch and Function Key Input	[ESC] U	Touch Switch Disable.	227
	[ESC] V	Touch Switch Enable.	227
System Control	[ESC] P	Screen Display Control	227
	[ESC] T	Buzzer Control	228
	[ESC] W	System Menu Display Permission	228
Notification	[ESC] Y	Screen Number Response	217
	[ESC] E	4-digit Number Input Notify	225
	[ESC] F	8-digit Number Input Notify	225
	[ESC] S	Lamp and Touch Switch Display Status Response	224
	[ESC] J	Touch Switch Bit Output (from NT20 to Host)	226
	[ESC] H	Touch Switch Number Output (from NT20 to Host)	226

### Terminal Commands

Type	Command	Name	Page
Character size	[ESC] &	Clear Screen.	229
	[ESC] )	Character Specify Size	229
	[ESC] *	Specify Character Enlargement.	230
Character Display Attributes	[ESC] !	Normal Display	230
	[ESC] “	Set Inverse Display.	230
	[ESC] #	End Inverse Display.	231
	[ESC] \$	Set Flashing Display.	231
	[ESC] %	End Flashing Display.	231
Character String Display	[ESC] +	Set Cursor Position.	232
	[ESC] 4	Specify Displayed Characters.	232
Graphic Display	[ESC] 7	Draw Polyline.	233
	[ESC] 8	Draw Circle.	233

## 6-2 RS-232C Communications

This section describes the communications procedure when using the NT20-ST128 (RS-232C), and program flow using examples in BASIC.

### 6-2-1 Communications Procedure

The Host and NT20 communicate according to the following procedure.

- 1,2,3...
1. The RS-232C circuit must be opened (i.e., communications enabled) before communications can start.
  2. Commands are used to control the PT and to receive notification from the NT20.
  3. Close the RS-232C circuit again after communications have been completed.

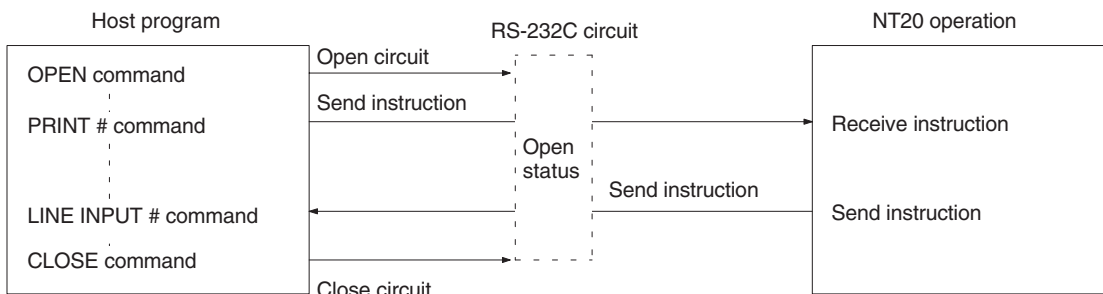

After a circuit has been opened, it can be used until it is closed again.

**OPEN:** Opens the RS-232C circuit. The Host communications conditions are also set.

Refer to 3-5-7 *Setting RS-232C Communications Conditions (NT20-ST128)* on page 99.

**PRINT#:** Sends an instruction via the RS-232C circuit to the NT20.

**LINE INPUT#:** Receives a command from the NT20. [LINE INPUT] is used when receiving input delimited by commas (,) or double quotation marks (").

**CLOSE:** Closes the RS-232C circuit.

Refer to the *Host's BASIC Manual* for more details about the commands.

#### Operation by Operating Commands

The operating commands display monitored data from the production line and messages to the factory workers. They are also used for NT20 control and management.

The communications flow between the Host and NT20 differs according to the following three cases:

#### Message from Host to NT20

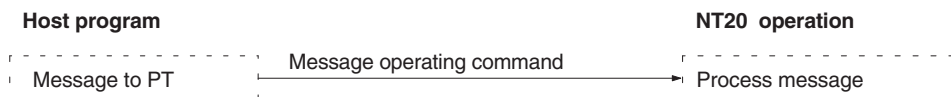

#### Enquiry from Host to NT20

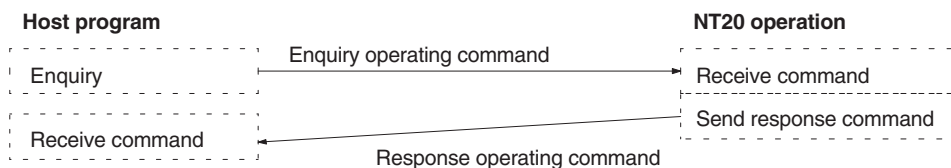

**Notification of Operation at NT20 to the Host**

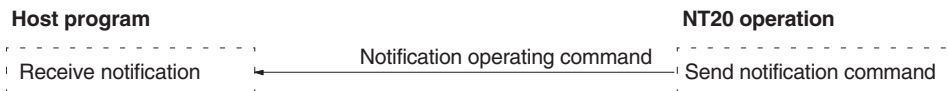

**Operation by Terminal Commands**

The terminal commands allow the NT20 to be used as a terminal of the Host to display text and graphics independently of the screens stored in the NT20. The Host sends a command and the NT20 processes the message. The NT20 does not send back a response to the Host.



**6-2-2 Precautions**

Some important points to consider when using commands are listed below.

**Commands**

If a personal computer is used as the host and a high-level language, such as BASIC or C, is used for programming, commands are specified with ASCII text strings.

In the descriptions in this section, parameters are given in lowercase letters. When specifying commands, specify any text given in uppercase letters as is and replace lowercase letters with ASCII text strings to specify the numeric values of the parameters (BCD or hexadecimal) or the text strings for parameters. Any text given in square brackets [ ], however, represents one control code, such as ESC or CR.

In the descriptions of commands, “4-digit BCD” indicates an ASCII text string of a 4-digit BCD value and “4-digit hexadecimal” indicates an ASCII text string of a 4-digit hexadecimal value. Do not specify BCD or hexadecimal values directly. Always use ASCII text strings to represent them.

**Example**

The command format for the Four-digit Numeral Memory Table Write command is as follows:

[ESC]	C	d <sub>1</sub>	d <sub>2</sub>	d <sub>3</sub>	n <sub>1</sub>	n <sub>2</sub>	n <sub>3</sub>	n <sub>4</sub>
1B	43	* *	* *	* *	* *	* *	* *	* *

Assuming that the following parameters were to be specified, the text string given below would actually be sent.

d<sub>1</sub> d<sub>2</sub> d<sub>3</sub>: 014 (3-digit hexadecimal)

n<sub>1</sub> n<sub>2</sub> n<sub>3</sub> n<sub>4</sub>: 1234 (4-digit BCD)

[ESC]	C	0	1	4	1	2	3	4
1B	43	30	31	34	31	32	33	34

**Note** In the descriptions of commands and responses, “\*\*\*” indicates the specified characters in ASCII (2-digit hexadecimal).

**Command Length**

If a mistake during command specification results in a command being too long, the correct length of the command is executed and the remainder is ignored.

A timeout error results if a mistake during command specification results in a command being too short.

**Interval between Transmitted Commands**

As a small number of bytes is transmitted by the Host, the interval between transmissions should not exceed 5 seconds if a command is divided up for transmission. A timeout error occurs if the interval between transmissions exceeds 5 seconds.

When commands are sent too frequently, a buffer overflow error may occur if the NT20 cannot keep up with the command processing.

In order to prevent buffer overflow, use flow control.

**Controlling PT Status with Operating Commands**

Control of the NT20 status by the operating commands is restricted by the NT20 memory switch settings as listed below.

Operating command	Restriction from memory switch setting
Buzzer control command [ESC] T	Effective when "buzzer turned on"

**Coordinate Specification with the Terminal Commands**

The entire command is ignored if any point specified at coordinates X, Y with the Terminal commands lies outside the screen.

**Error Display**

If the "automatic reset after communications" memory switch of the NT20 is set to ON, no message is displayed when a communications error occurs.

However, time-out errors are displayed.

## 6-3 Screen Display

This section describes the commands for switching the screen display of the NT20S and the commands for ascertaining the screen number of the screen currently displayed by the NT20.

The displayed screen can be also switched by pressing a touch switch for which the screen number of the screen to be displayed has been registered. For details on this method, refer to *4-7-2 Screen Switching Function* on page 154.

To change the NT20 screen, use the Display Specified Screen Command. To ascertain the screen number of the currently displayed screen, use the Request Screen Number Command. When this command is executed, the NT20 returns the Screen Number Response Command.

When the currently displayed NT20 screen is changed by pressing a touch switch to which a screen number has been allocated, the Screen Number Response Command is automatically sent from the NT20.

### Display Specified Screen

#### Format

[ESC]	0	m <sub>1</sub>	m <sub>2</sub>	m <sub>3</sub>	m <sub>4</sub>
1B	30	* *	* *	* *	* *

m<sub>1</sub>m<sub>2</sub>m<sub>3</sub>m<sub>4</sub>: Number of displayed screen (4-digit hexadecimal)

0000: No display

0001 to 01F4: Screen #1 to #500

#### Description

The specified screen is displayed on the NT20 when a screen number is sent from the Host with this command.

### Request Screen Number

#### Format

[ESC]	x
1B	58

#### Description

Enquires what number screen is displayed on the NT20. The NT20 returns the number of the displayed screen using the Screen Number Response Command (refer to *Screen Number Response* on page 217).

**Screen Number Response****Format**

[ESC]	Y	m <sub>1</sub>	m <sub>2</sub>	m <sub>3</sub>	[CR]
1B	59	* *	* *	* *	OD

m<sub>1</sub>m<sub>2</sub> m<sub>3</sub>: Number of displayed screen (4-digit hexadecimal)  
000 to 1F4 (0 to 500)

**Description**

- The NT20 returns this command to report the currently displayed screen number to the Host in response to the Request Screen Number Command (refer to *Screen Number Response*) sent from the Host.
- The new screen number is report to the Host with this command after the displayed screen is switch with the Stand-alone functions (screen switch function).

## 6-4 Memory Tables

This section explains the commands used for memory table operations.

To change the contents of a character string memory table entry, use the Write Character-string Memory Table Command.

To change the contents of a numeral memory table entry, use a Write Numeral Memory Table Command.

Note that different commands are used to write 4-digit and 8-digit numerical values.

Values can be copied from one memory table entry to another of the same type by using the Copy Memory Table Command.

### Reference

- When the contents of an NT20 numeral memory table entry are changed by numeral setting input, a Number Input Notify Command is automatically sent from the NT20 (refer to *6-5-2 Notification of Numeral Setting Input and Touch Switch Status*).
- By creating a bar graph screen and arranging for it to refer to a particular numeral memory table entry, the display contents of the bar graph can be updated by changing the contents of the numeral table entry.

### Write Character-string Memory Table

#### Format

[ESC]	B	n <sub>1</sub>		n <sub>2</sub>		d <sub>1</sub>		d <sub>2</sub>		c <sub>1</sub>	c <sub>2</sub>	c <sub>3</sub>	---	c <sub>n</sub>	
1B	42	*	*	*	*	*	*	*	*	*	*	*	{}	*	*

n<sub>1</sub>n<sub>2</sub>: Character string length as a number of normal characters (2-digit hexadecimal) 01 to 20<sub>H</sub> (1 to 32)

d<sub>1</sub>d<sub>2</sub>: Character-string memory table entry number of write destination (2-digit hexadecimal) 00 to 7F<sub>H</sub> (0 to 127)

c<sub>1</sub>c<sub>2</sub>c<sub>3</sub> to c<sub>n</sub>: Character-string data

#### Description

Writes the character-string data to the character-string memory table entry.

The character-string data can contain a mixture of normal alphanumeric characters and marks. When determining the character string length, count each mark as two normal characters.

**⚠ Caution** If the actual character string is longer than the specified character string length, the specified number of characters is written and the remainder are discarded.

A timeout error message is displayed if the actual character string is shorter than the specified character string length.

### Four-digit Write Numeral Memory Table

**Format**

[ESC]	C	d <sub>1</sub>	d <sub>2</sub>	d <sub>3</sub>	n <sub>1</sub>	n <sub>2</sub>	n <sub>3</sub>	n <sub>4</sub>
1B	43	* *	* *	* *	* *	* *	* *	* *

d<sub>1</sub>d<sub>2</sub>d<sub>3</sub>: Numeral memory table entry number of write destination (3-digit hexadecimal) 000 to 07FH (0 to 127)

n<sub>1</sub>n<sub>2</sub>n<sub>3</sub>n<sub>4</sub>: Number data (4-digit BCD or 4-digit hexadecimal)

**Description**

- Writes the 4-digit number data (decimal or hexadecimal) to the specified numeral memory table.
- If a 4-digit number data is written while an 8-digit numeral is displayed, the lower 4 digits are updated.

**Caution** This command cannot be used to write negative numbers. Use the 8-digit Write Command (refer to *Eight-digit Write Numeral Memory Table* on page 219).

### Eight-digit Write Numeral Memory Table

**Format**

[ESC]	D	d <sub>1</sub>	d <sub>2</sub>	d <sub>3</sub>	n <sub>1</sub>	n <sub>2</sub>	n <sub>3</sub>	n <sub>4</sub>	n <sub>5</sub>
1B	44	* *	* *	* *	* *	* *	* *	* *	* *
		n <sub>6</sub>	n <sub>7</sub>	n <sub>8</sub>					
		* *	* *	* *					

d<sub>1</sub>d<sub>2</sub>d<sub>3</sub>: Numeral memory table entry number of write destination (3-digit hexadecimal) 000 to 07FH (0 to 127)

n<sub>1</sub>n<sub>2</sub>n<sub>3</sub>n<sub>4</sub>n<sub>5</sub>n<sub>6</sub>n<sub>7</sub>n<sub>8</sub>: Number data (8-digit BCD or 8-digit hexadecimal)

**Description**

- Writes the 8-digit number data (decimal or hexadecimal) to the specified numeral memory table entry.
- To write a negative numeral (decimal), specify “F(46H)” for “n1” (in this case, a 7-digit numeral is written.).



**Copy Memory Table****Format**

[ESC]	/	m <sub>1</sub>	s <sub>1</sub>	s <sub>2</sub>	s <sub>3</sub>	d <sub>1</sub>	d <sub>2</sub>	d <sub>3</sub>
1B	2F	* *	* *	* *	* *	* *	* *	* *

m<sub>1</sub>: Type of memory table

0 (30<sub>H</sub>): Character-string memory table

1 (31<sub>H</sub>): Numeral memory table

s<sub>1</sub>s<sub>2</sub>s<sub>3</sub>: Copy source memory table entry number

000 to 127 (3-digit BCD)

d<sub>1</sub>d<sub>2</sub>d<sub>3</sub>: Copy destination memory table entry number

000 to 127 (3-digit BCD)

**Description**

Copies the contents of the copy source memory table entry to the copy destination memory table entry. The memory table entry contents are copied to a memory table entry of the same type: character-string memory table entry to character-string memory table entry or numeral memory table entry to numeral memory table entry .

## 6-5 Lamps, Touch Switches, Numeral Setting

This section describes the commands for operating the lamps, touch switches.

In order to change the display status (lit (flashing) or unlit) of a lamp or touch switch, use the Lamp and Touch Switch Display Commands. There are two such commands, one for bit specification and the other for number specification.

The Lamp and Touch Switch Display Status Enquiry Command is used to ascertain the status of a lamp or touch switch. When this command is executed the NT20 returns the Lamp/Touch Switch Display Status Response Command.

### Reference

When the status of an NT20 touch switch is changed - for example by pressing it - the Touch Switch Number Output Command is sent to the host. When a numerical value is input by pressing a touch switch to which a numeral setting function has been allocated, a Number Input Notify Command is sent to the host.

### 6-5-1 Notification and Control of Touch Switches

If a touch switch is pressed, the corresponding touch switch number or bit information is sent to the Host. Conversely, to turn ON a touch switch or cause it to flash, the touch switch # or bit information is sent from the Host.

The type of data relating to the touch switch notification is specified with the "bit input attribute" in the screen attributes when creating the screen data with the Support Tool. It is not permissible to use both notification and control by a touch switch number and notification and control by bit information on the same screen.

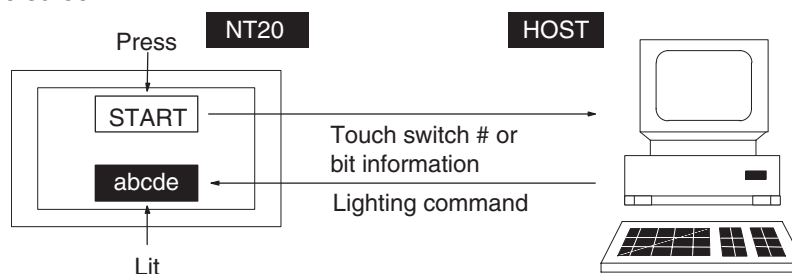

- Bit Touch Switch Method (Bit Input Permitted Setting)

If a touch switch is pressed, bit information is sent according to the position of the touch switch. It can be used as a normal bit input switch at the PLC. When this method is used, if more than one touch switch is pressed at the same time, the information of all the pressed touch switches (0 to 63) is reported to the Host.

- Touch Switch # Method (Bit Input Not-permitted Setting)

If the touch switch status is changed, the touch switch number set when the touch switch is created is sent as a 8-digit hexadecimal number.

### Cautions When Bit Input Is Permitted

If the touch switches are set in the following positions using the Support Tool while the setting is "bit input permitted", the following operations will occur due to the configuration of the touch switches.

Take this into consideration when setting touch switch areas.

Example 1:

Touch switches are set at positions A, B, C, and D using the minimum switch setting unit.

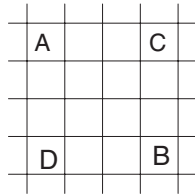

- If switches A, B, and C are turned ON at the same time, switch D is also set ON.
- Similarly, if switches A, B, and D are turned ON at the same time, switch C is also set ON.

Example 2:

Touch switch areas E, F, and G are set.

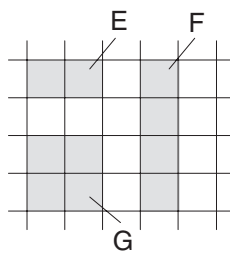

- If switches E and F are turned ON at the same time, switch G is also set ON.

**Touch Switch Notification/control and Attributes**

Inverse and normal display states can be set as attributes of touch switches by using the Support Tool. There are slight differences in the operation when a touch switch is pressed depending on whether bit input is permitted or not permitted.

Bit input not permitted: Touch switch notification by number

The touch switch is lit for 0.2 seconds when pressed and then returns to the unlit status.

Bit input permitted: Touch switch notification by bit information

The touch switch is lit while pressed and returns to the unlit status when released.

When a touch switch which is currently lit or flashing is pressed, it is continuously lit while pressed and returns to its original state when released.

**Simultaneous Pressing of Multiple Touch Switches**

Two or more touch switches can be simultaneously pressed if their status is sent by bit information or if they use different host notification methods. However, two or more switches cannot be simultaneously pressed if host is notified of their status by their numbers.

**Lamp and Touch Switch Display (Bit Specification)**

**Format**

[ESC] K m0<sub>1</sub> m0<sub>2</sub> m1<sub>1</sub> m1<sub>2</sub> m2<sub>1</sub> m2<sub>2</sub> m3<sub>1</sub> m3<sub>2</sub> [CR]

1B	4B	*	*	*	*	*	*	*	*	*	*	*	*	*	*	0D
----	----	---	---	---	---	---	---	---	---	---	---	---	---	---	---	----

m0 to m3: Specification of lamps and touch switches (2-digit hexadecimal)  
 The relationship between the lamp and touch switch number and an expression of m0 to m3 in bits is given in the following table.

Bit	mx <sub>1</sub>				mx <sub>2</sub>			
Parameter	7	6	5	4	3	2	1	0
<b>m0</b>	07	06	05	04	03	02	01	00
<b>m1</b>	15	14	13	12	11	10	09	08
<b>m2</b>	23	22	21	20	19	18	17	16
<b>m3</b>	31	30	29	28	27	26	25	24

mx1: Higher 4 bits of mx (x: 0 to 3)

mx2: Lower 4 bits of mx

Bit ON: The lamp or touch switch is turned on (or caused to flash).

Bit OFF: The lamp or touch switch is turned off.

**Example**

To turn on lamps and touch switches with the numbers 1, 5, 6, 7, and 26

**m01m02m11m12m21m22m31m32=E2000004**

**Description**

- Changes the display status of the lamps or touch switches.
- Whether the lamp or touch switch which corresponds to the specified bit is turned on or flashes is determined by the setting made using the Support Tool.
- This command can be used only when the setting for the “LMP Bit Control” memory switch is “Enable”.

**Lamp and Touch Switch Display (Number Specification)**

**Format**

[ESC] Q m<sub>1</sub> n<sub>1</sub> n<sub>2</sub>

1B	51	*	*	*	*	*	*
----	----	---	---	---	---	---	---

m<sub>1</sub>: Display status  
 0 (30H): Not lit (normal display)  
 1 (31H): Lit  
 2 (32H): Flashing inverse  
 3 (33H): All not lit

n<sub>1</sub>n<sub>2</sub>: Lamp or touch switch # (2-digit hexadecimal)  
 000 to FFH (0 to 255)

**Description**

Changes the lamp or touch switch lighting status.

Specify the display status as 3 (all not lit) to turn off all the lamps and touch switches. In this case, specify the lamp or touch switch number to any number in the permitted range.

**⚠ Caution** The display attributes set with the Support Tool determine if lamps #0 to #31 light continuously or flash. The display status set with this command is ignored.

### Lamp and Touch Switch Display Status Enquiry

#### Format

[ESC]	R	n <sub>1</sub>		n <sub>2</sub>
1B	52	* *	* *	

n<sub>1</sub>n<sub>2</sub>: Lamp or touch switch # (2-digit hexadecimal)  
000 to FFH (0 to 255)

#### Description

Enquires the status of a lamp or touch switch specified by its address.

The NT20 returns the Lamp and Touch Switch Display Status Response Command (refer to *Lamp and Touch Switch Display Status Response* below) to report the display status.

### Lamp and Touch Switch Display Status Response

#### Format

[ESC]	S	m <sub>1</sub>	n <sub>1</sub>		n <sub>2</sub>
1B	53	* *	* *	* *	

m<sub>1</sub>: Display status  
0 (30H): Not lit (normal display)  
1 (31H): Lit  
2 (32H): Flashing inverse

n<sub>1</sub>n<sub>2</sub>: Lamp or touch switch # (2-digit hexadecimal)  
0 to FFH (0 to 255)

#### Description

The NT20 returns this command to report the lamp or touch switch number display status to the Host in response to the Lamp and Touch Switch Display Status Enquiry Command (refer to *Lamp and Touch Switch Display Status Enquiry*) sent from the Host.

**Note** Lamps 0 to 31 are reported as being lit when in the “flashing inverse” status.

## 6-5-2 Notification of Numeral Setting Input and Touch Switch Status

The following describes the commands for notifying the host when numeral setting is performed (i.e., when the contents of a numeral memory table entry are changed by pressing a touch switch) or when a touch switch is pressed, when operating the NT20.

When a numerical value is input by numeral setting, the NT20 sends a Number Input Notify Command to the host. The command sent differs depending on whether a 4-digit or 8-digit number is input.

When a touch switch is pressed, the NT20 sends a Touch Switch Number Output Command or Touch Switch Bit Output Command to the host. The command sent depends on the set screen attributes.

### Four-digit Number Input Notify

#### **Format**

[ESC]	E	d <sub>1</sub>	d <sub>2</sub>	d <sub>3</sub>	n <sub>1</sub>	n <sub>2</sub>	n <sub>3</sub>	n <sub>4</sub>	[CR]	
1B	45	*	*	*	*	*	*	*	*	0D

d<sub>1</sub>d<sub>2</sub>d<sub>3</sub>: Numeral memory table entry number to which number was input (3-digit hexadecimal) 000 to 07FH (0 to 127)

n<sub>1</sub>n<sub>2</sub>n<sub>3</sub>n<sub>4</sub>: Input number data (4-digit BCD)

#### **Description**

A number with 4 transferred digits set with the NT20 number setting function is reported to the Host with this command.

**⚠ Caution** This command cannot be used for negative numbers. Always set “8” as the number of transferred digits when negative numbers may be input.

### Eight-digit Number Input Notify

#### **Format**

[ESC]	F	d <sub>1</sub>	d <sub>2</sub>	d <sub>3</sub>	n <sub>1</sub>	n <sub>2</sub>	n <sub>3</sub>	n <sub>4</sub>	n <sub>5</sub>	}
1B	46	*	*	*	*	*	*	*	*	
		n <sub>6</sub>	n <sub>7</sub>	n <sub>8</sub>	[CR]					
		*	*	*	*	0D				

d<sub>1</sub>d<sub>2</sub>d<sub>3</sub>: Numeral memory table entry number to which number was input (3-digit hexadecimal) 000 to 07FH (0 to 127)

n<sub>1</sub>n<sub>2</sub>n<sub>3</sub>n<sub>4</sub>n<sub>5</sub>n<sub>6</sub>n<sub>7</sub>n<sub>8</sub>: Input number data (8-digit BCD)

#### **Description**

A number with 8 transferred digits set with the PT number setting function is reported to the Host with this command.

When a negative number is written, n<sub>1</sub> becomes “F” (46H) and the number comprises 7 digits.

**Touch Switch Number Output (from NT20 to Host)**

**Format**

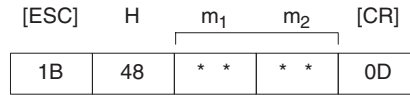

m<sub>1</sub>m<sub>2</sub>: Address of the pressed touch # (2-digit hexadecimal)  
00 to E2H (0 to 226)

**Description**

If a touch switch is pressed while the screen for which the “Bit In = Off” attribute is set is displayed, the address of the pressed touch switch is reported to the Host.

**Reference:**

If more than one touch switch is pressed at the same time, only the address of the touch switch which was pressed first is reported to the Host.  
Notification of numeral setting is not executed in the case of touch switches which have been allocated as ten keys.

**Touch Switch Bit Output (from NT20 to Host)**

**Format**

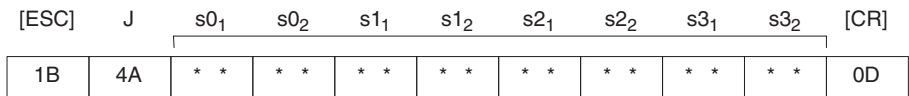

s<sub>0</sub>,... s<sub>3</sub>: Status of the touch switch (2-digit hexadecimal value for each switch)  
The relationship between the touch switch number and an expression of s<sub>0</sub> to s<sub>3</sub> in bits is given in the following table.

Bit	s <sub>x</sub> <sub>1</sub>				s <sub>x</sub> <sub>2</sub>			
Parameter	7	6	5	4	3	2	1	0
s <sub>0</sub>	07	06	05	04	03	02	01	00
s <sub>1</sub>	15	14	13	12	11	10	09	08
s <sub>2</sub>	23	22	21	20	19	18	17	16
s <sub>3</sub>	31	30	29	28	27	26	25	24

- sx<sub>1</sub>: Higher 4 bits of s<sub>x</sub> (x: 0 to 3)
- sx<sub>2</sub>: Lower 4 bits of s<sub>x</sub>
- Bit ON: The touch switch is on.
- Bit OFF: The touch switch is off.

**Example**

Touch switches at addresses 0, 3, 21, and 27 are ON  
**s01s02s11s12s21s22s31s32=09002008**

**Description**

- If the touch switch status is changed while the screen for which the “Bit Input, Touch Switch” attribute is set is displayed, the status of the corresponding bit is reported to the Host.
- This report is made each time a touch switch is turned ON or OFF.

## 6-6 Controlling the NT20 Status

This section describes the actual methods used for controlling the NT20 status.

The Screen Display Control Command is used to operate the back light of the NT20 (i.e., switch it on and off).

The Buzzer Control Command is used to control the buzzer status of the NT20. To inhibit the display of the system menu or cancel this inhibition, use the Mode Switch Enable Command.

Touch switch data input or host notification can be inhibited, or this inhibition canceled, by using the Touch Switch and Function Key Disable Command or Touch Switch and Function Key Enable Command respectively.

### Touch Switch Disable

#### **Format**

[ESC] U 2

1B	55	32
----	----	----

#### **Description**

Disables touch switch and function key input and notification to the Host.

#### **Reference:**

Use the Touch Switch Enable Command (refer to *Touch Switch Enable*) to use a disabled touch switch again. Disabled touch switches are also enabled when the NT20 power is turned off.

### Touch Switch Enable

#### **Format**

[ESC] V 2

1B	56	32
----	----	----

#### **Description**

Enables input and notification to the Host of a disabled touch switch or function key.

#### **Reference:**

Disabled touch switches are also enabled when the NT20 power is turned off.

### Screen Display Control

#### **Format**

[ESC] P m<sub>1</sub>

1B	50	* *
----	----	-----

m<sub>1</sub>: Display on or off  
 0 (30H): on  
 1 (31H): off

#### **Description**

Turns off the backlighting.

#### **Reference:**

The screen is redisplayed if a touch switch is pressed.

When a Display Specified Screen Command on page 216 is sent, the specified screen is displayed.



**Buzzer Control****Format**[ESC] T m<sub>1</sub>

1B	54	* *
----	----	-----

m<sub>1</sub>: Buzzer status

0 (30H): Buzzer off

1 (31H): Continuous buzzer

2 (32H): Short intermittent buzzer

**Description**

Controls the NT20 buzzer.

**Reference:**

The buzzer turned on with this command can be stopped with a Buzzer control command, press the “buzzer stop” touch switch on the screen, or by displaying a screen with no buzzer attributes.

**System Menu Display Permission****Format**[ESC] W m<sub>1</sub>

1B	57	* *
----	----	-----

m<sub>1</sub>: System menu display permission/inhibition

0 (30H): Display permitted

1 (31H): Display inhibited

**Description**

System menu is displayed when “display permitted” is set, and from the system menu, selection of transmit mode or maintenance mode is possible. If “display inhibited” is set, the system menu is not displayed.

Turning off the power or resetting operation validates the settings made with the DIP switch (SW2-3) on the NT20.

## 6-7 Terminal Commands

This section describes the terminal commands used to display character strings or graphics according to instructions from the host, independently of the screens registered in the NT20.

Terminal commands designate screen attributes such as inversion, flashing, cursor position and size of characters before the characters are displayed.

Once screen attributes are set, they remain effective for screen displays until they are cancelled or other attributes are set.

In addition, continuous lines and circles can be drawn.

### Clear Screen

#### Format

[ESC] &

1B	26
----	----

#### Description

Clears all text and graphics on the NT20 screen.

#### Reference:

Even if this command is used to clear a screen, the NT20 still displays the preceding screens.

After the display of number, text, lamps or touch switches is upgraded, only the upgraded parts are re-displayed.

### Character Specify Size

#### Format

[ESC] ) m<sub>1</sub>

1B	29	* *
----	----	-----

m<sub>1</sub>: Character size  
 0 (30H): Normal size, 16 x 8 dots (H x W)  
 1 (31H): 1/2 size, 8 x 8 dots (H x W)

#### Description

Specifies if 1-byte alphanumeric characters sent subsequently are displayed as normal characters or 1/2-size characters.

#### Reference:

The character string is specified with the Specify Displayed Characters Command (refer to *Specify Displayed Characters*). Both normal characters and 1/2-size characters are enlarged as specified by the Specify Character Enlargement Command (refer to *Specify Character Enlargement* below).

The character size specified with this command remains valid until the screen display is switched or another character size is specified with the command. The default character size is normal characters.

## Specify Character Enlargement

### Format

[ESC] \* m<sub>1</sub>

1B	2A	* *
----	----	-----

m<sub>1</sub>: Character enlargement  
 0 (30H): No enlargement  
 1 (31H): Enlarge height x 2  
 2 (32H): Enlarge width x 2  
 3 (33H): 2 x 2 enlargement  
 4 (34H): 3 x 3 times enlargement  
 5 (35H): 4 x 4 times enlargement

### Description

All text and marks sent after this command are displayed in the specified size.

### Reference:

The character string is specified with the Specify Displayed Characters Command (refer to *Specify Displayed Characters*).

The enlargement specified with this command remains valid until the screen display is switched or another enlargement is specified with the command. The default enlargement is no enlargement.

## Normal Display

### Format

[ESC] !

1B	21
----	----

### Description

Cancels all display attribute settings (inverse, flashing, flashing inverse) for characters and marks so that all characters are displayed as “normal” characters (not inverse or flashing).

## Set Inverse Display

### Format

[ESC] ”

1B	22
----	----

### Description

Sets the display attribute to inverse so that all characters and marks sent subsequently are highlighted. Other attributes remain unchanged.

### Reference:

The Set Inverse Display Command is cancelled by the End Inverse Display Command or the Normal Display Command.

The setting with this command remains valid until the screen display is switched or another display attribute setting is made. The default display attributes are set to a normal display when a screen is initially displayed.

Use this command with the Set Flashing Display Command (refer to *Set Flashing Display*) to produce a flashing inverse display.

**End Inverse Display****Format**

[ESC] #

1B	23
----	----

**Description**

Clears the inverse display attribute so that all characters and marks sent subsequently are not highlighted. Other attributes remain unchanged.

**Reference:**

The inverse display attribute is set with the Set Inverse Display Command.

The setting with this command remains valid until the screen display is switched or another display attribute setting is made. The default display attributes are set to a normal display when a screen is initially displayed.

**Set Flashing Display****Format**

[ESC] \$

1B	24
----	----

**Description**

Sets the display attribute to flashing so that all characters and marks sent subsequently are displayed flashing. Other attributes remain unchanged.

**Reference:**

The Set Flashing Display Command is cancelled by the End Flashing Display Command or the Normal Display Command (refer to *Normal Display* and *End Inverse Display*).

The setting with this command remains valid until the screen display is switched or another display attribute setting is made. The default display attributes are set to a normal display when a screen is initially displayed.

Use this command with the Set Inverse Display Command (refer to *Set Inverse Display*) to produce a flashing inverse display.

**End Flashing Display****Format**

[ESC] %

1B	25
----	----

**Description**

Clears the flashing display attribute so that all characters and marks sent subsequently are not flashing. Other attributes remain unchanged.

**Reference:**

The flashing display attribute is set with the Set Flashing Display Command.

The setting with this command remains valid until the screen display is switched or another display attribute setting is made. The default display attributes are set to a normal display when a screen is initially displayed.

**Set Cursor Position****Format**

[ESC]	+	x <sub>1</sub> x <sub>2</sub> x <sub>3</sub>			y <sub>1</sub> y <sub>2</sub> y <sub>3</sub>		
1B	2B	* *	* *	* *	* *	* *	* *

x<sub>1</sub>x<sub>2</sub>x<sub>3</sub>: X coordinate (3-digit BCD)  
000 to 255

y<sub>1</sub>y<sub>2</sub>y<sub>3</sub>: Y coordinate (3-digit BCD)  
000 to 127

**Description**

Before displaying a character string with the Terminal commands, use this command to set the bottom-left point of the first character to be displayed.

**Reference:**

The cursor position set with this command is also the bottom-left point of the first character displayed if the displayed characters are enlarged.

**Specify Displayed Characters****Format**

[ESC]	4	n <sub>1</sub> n <sub>2</sub>		c <sub>1</sub>	c <sub>2</sub>	c <sub>3</sub>	---	c <sub>n</sub>
1B	34	* *	* *	* *	* *	* *	{ }	* *

n<sub>1</sub>n<sub>2</sub>: Character string length as a number of normal characters  
(2-digit hexadecimal)  
01 to 20H (1 to 32)

c<sub>1</sub>c<sub>2</sub>c<sub>3</sub> to c<sub>n</sub>: Character-string to display

**Description**

- The character string is displayed from the cursor position.
- The character-string data can contain a mixture of normal (alphanumeric) characters and marks. Refer to *Appendix H Special Characters* for details.
- The character string is displayed according to the enlargement and display attributes set with commands.

**Reference:**

The character string continues on the next line if it cannot fit into a single line.

Set the position where the character string is displayed with the Set Cursor Position Command (refer to *Set Cursor Position*).

**Draw Polyline****Format**

[ESC]	7	m <sub>1</sub> m <sub>2</sub>		x0 <sub>1</sub> x0 <sub>2</sub> x0 <sub>3</sub>	y0 <sub>1</sub> y0 <sub>2</sub> y0 <sub>3</sub>	---			
1B	37	* *	* *	* *	* *	* *	* *	* *	*
		x <sub>n1</sub> x <sub>n2</sub> x <sub>n3</sub>			y <sub>n1</sub> y <sub>n2</sub> y <sub>n3</sub>				
		* *	* *	* *	* *	* *	* *		

m<sub>1</sub>, m<sub>2</sub>: Number of lines to draw (2-digit hexadecimal)  
01 to 28H (1 to 40)

x0<sub>1</sub>x0<sub>2</sub>x0<sub>3</sub> to x<sub>n1</sub>x<sub>n2</sub>x<sub>n3</sub>: X coordinates of line end points (3-digit BCD)  
000 to 255

y0<sub>1</sub>y0<sub>2</sub>y0<sub>3</sub> to y<sub>n1</sub>y<sub>n2</sub>y<sub>n3</sub>: Y coordinates of line end points (3-digit BCD)  
000 to 127

**Description**

Draws the specified number of lines between the specified points.

**Draw Circle****Format**

[ESC]	8	x <sub>1</sub> x <sub>2</sub> x <sub>3</sub>	y <sub>1</sub> y <sub>2</sub> y <sub>3</sub>	r <sub>1</sub> r <sub>2</sub> r <sub>3</sub>					
1B	38	* *	* *	* *	* *	* *	* *	* *	* *

x<sub>1</sub>x<sub>2</sub>x<sub>3</sub>: X coordinate of circle center (3-digit BCD)  
000 to 255

y<sub>1</sub>y<sub>2</sub>y<sub>3</sub>: Y coordinate of circle center (3-digit BCD)  
000 to 127

r<sub>1</sub>r<sub>2</sub>r<sub>3</sub>: circle radius in dots (3-digit BCD)  
001 to 063

**Description**

Draws a circle of the specified radius around the circle center point.

## 6-8 Key to Programs

The following programs include all the commands that can be used with the NT20.

### 6-8-1 Use of Programs

The sample program appears as follows on the screen.

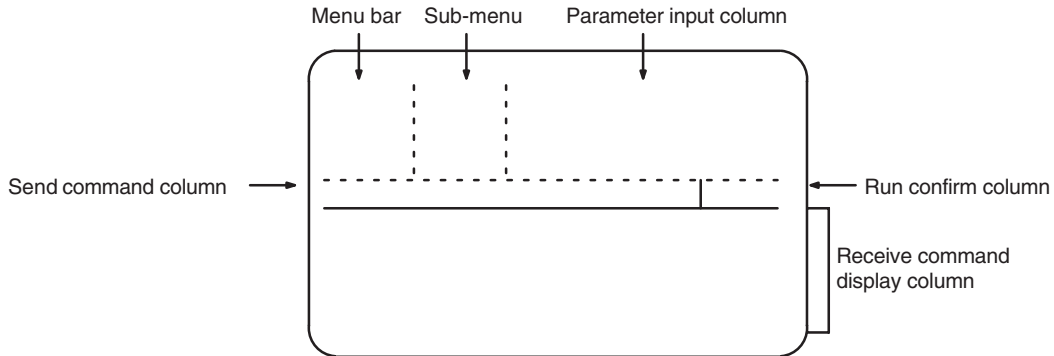

Use the program as shown below.

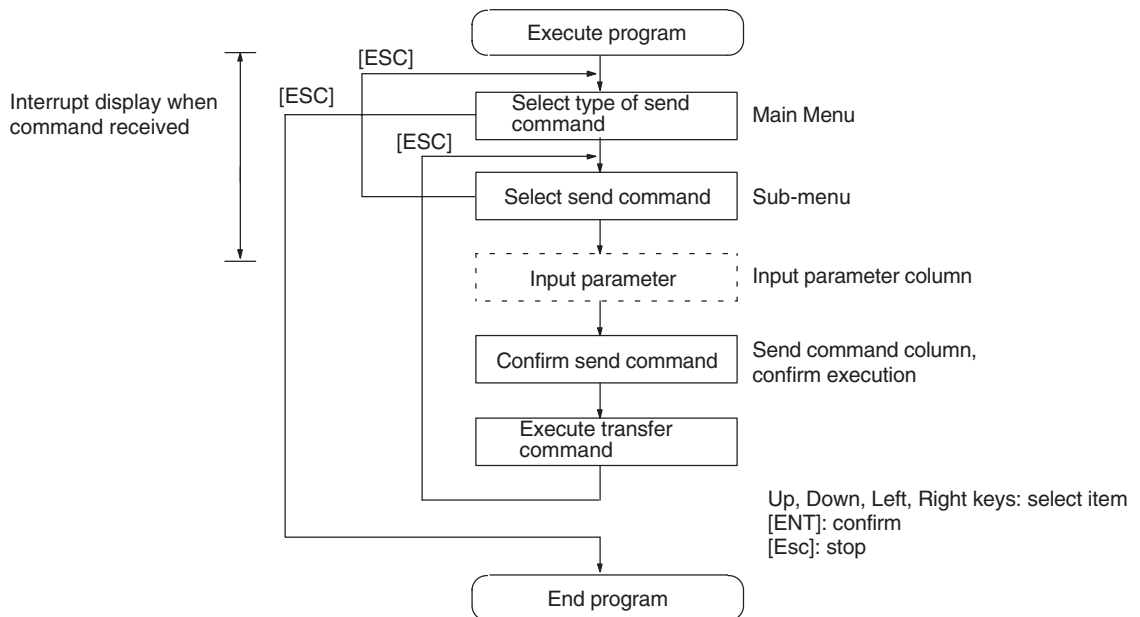

1. This sample program is written in N88BASIC (86) (NEC) for a PC-9801 computer. Modify this program for use with any other computer language or computer such as an IBM PC/AT or compatible.
2. The interval between parameter input and command transmission is a hold interval for interrupt processing of the received command. If an interrupt is permitted between the interval of parameter input and a command is received, all subsequent receive interrupts are displaced. If this occurs, send an enquiry command to read all the accumulated receive data.
3. When a parameter is input, no check is made that the parameter is in the permitted range. Make sure that parameters are input within the permitted range.

**Example Program**

```

1000 ' *****
1010 ' * OPERATION COMMAND EXAMPLE PROGRAM (NT20-ST128)*
1020 ' *****
1030 ' ..... Draw screen frame
1040 SECT=9
1050 DIM CMND$(SECT,10,1),CMND(SECT),TS.B(31)
1060 SCREEN 3:CLS 3:CONSOLE 15,10,0,0
1070 LINE (0,176)-(639,176),7,,&HF0F0
1080 LINE (159,0)-(159,176),7,,&HF0F0
1090 LINE (300,0)-(300,176),7,,&HF0F0
1100 LINE (0,16)-(159,16),7,,&HF0F0
1110 LINE (0,96)-(159,96),7,,&HF0F0
1120 LINE (0,112)-(159,112),7,,&HF0F0
1130 LINE (520,176)-(520,224),7,,&HF0F0
1140 LINE (0,223)-(639,224),7,B
1150 COLOR 0:LOCATE 2,0:PRINT "OPERATING COMMANDS"
1160 COLOR 0:LOCATE 2,6:PRINT "TERMINAL COMMANDS"
1170 CMND(0)=SECT ' ..... Set display character strings
1180 FOR I=1 TO SECT
1190   READ CMND$(0,I,0)
1200 NEXT I
1210 FOR I=1 TO SECT
1220   READ CMND(I)
1230   FOR J=1 TO CMND(I)
1240     READ CMND$(I,J,0),CMND$(I,J,1)
1250     IF CMND$(I,J,1) = "#####" THEN CMND$(I,J,1) = "[ESC]" + CHR$(&H22)
1260   NEXT J
1270 NEXT I
1280 '
1290 RY=15
1300 ON COM(1) GOSUB *RECV ' ..... Set receive interrupt routine
1310 OPEN "COM1:E81NN" AS #1 ' ..... Open communications port
1320 ' NT20_SETTING OF RS-232C
1330 ' DATA BIT LENGTH      8 BITS
1340 ' STOP BIT LENGTH      1 BIT
1350 ' PARITY                ODD
1360 ' FLOW CONTROL         RS/CS
1370 ' BAUD RATE            (VALUE SET BY SWITCH COMMAND)
1380 COM(1) ON
1390 '
1400 *LV0 ' ..... Main Menu
1410 LV=0:SECT.NO=0:SEL.NO=1
1420 GOSUB *SELECT
1430 IF SEL.NO=0 THEN GOTO *PRO.END

```



```
1440 SECT.NO = SEL.NO
1450 '
1460 *LV1 ' . . . . . Sub-menu
1470 LV=1:SEL.NO=1
1480 GOSUB *SELECT
1490 IF SEL.NO=0 THEN GOTO *LV0
1500 *LV2 ' . . . . . Branch according to command (parameter input)
1510 COM(1) STOP
1520 LV=2:SEND$=CMND$(SECT.NO,SEL.NO,1)
1530 *SECT1
1540 IF SECT.NO<>1 THEN GOTO *SECT2
1550   ON SEL.NO GOSUB *ESC.0,*ESC.X
1560 *SECT2
1570 IF SECT.NO<>2 THEN GOTO *SECT3
1580   ON SEL.NO GOSUB *ESC.B,*ESC.C,*ESC.D,*ESC.2F
1590 *SECT3
1600 IF SECT.NO<>3 THEN GOTO *SECT4
1610   ON SEL.NO GOSUB *ESC.K,*ESC.Q,*ESC.R
1620 *SECT4
1630 IF SECT.NO<>4 THEN GOTO *SECT5
1640   ON SEL.NO GOSUB *ESC.U,*ESC.V
1650 *SECT5
1660 IF SECT.NO<>5 THEN GOTO *SECT6
1670   ON SEL.NO GOSUB *ESC.P,*ESC.T,*ESC.W
1680 *SECT6
1690 IF SECT.NO<>6 THEN GOTO *SECT7
1700   ON SEL.NO GOSUB *ESC.26,*ESC.29,*ESC.2A
1710 *SECT7
1720 IF SECT.NO<>7 THEN GOTO *SECT8
1730   ON SEL.NO GOSUB *ESC.21,*ESC.22,*ESC.23,*ESC.24,*ESC.25
1740 *SECT8
1750 IF SECT.NO<>8 THEN GOTO *SECT9
1760   ON SEL.NO GOSUB *ESC.2B,*ESC.4
1770 *SECT9
1780 IF SECT.NO<>9 THEN GOTO *LV2.END
1790   ON SEL.NO GOSUB *ESC.7,*ESC.8
1800 *LV2.END ' . . . . . Confirm transmission
1810 LOCATE 0,12:PRINT LEFT$(SEND$,56);
1820 IF LEN(SEND$)>56 THEN PRINT "... "
1830 LOCATE 66,12:PRINT "OK?";
1840 YN=1
1850 *YN.KY.IN
1860 LOCATE 74,12:COLOR 2+2*YN:PRINT "Y";:COLOR 2-2*YN:PRINT "N";
1870 A$=INKEY$:IF A$="" THEN GOTO *YN.KY.IN
1880 IF A$=CHR$(&H1C) OR A$=CHR$(&H1D) THEN YN=YN*(-1):GOTO *YN.KY.IN
1890 IF A$<>CHR$(&HD) THEN GOTO *YN.KY.IN
```

```

1900 LOCATE 66,12:COLOR 0:PRINT SPACE$(14);
1910 IF YN=-1 THEN GOTO *LV3.END
1920 GOSUB *SEND ' ..... Send command
1930 COM(1) ON
1940 LOCATE 43,9:COLOR 4:PRINT "Press ESC Key";:COLOR 0
1950 *SND.KY.IN
1960 A$=INKEY$:IF A$<>CHR$(&H1B) THEN *SND.KY.IN
1970 *LV3.END
1980 LOCATE 0,12:PRINT SPACE$(79);
1990 FOR I=0 TO 10
2000 LOCATE 39,I:PRINT SPACE$(40);
2010 NEXT I
2020 GOTO *LV1 ' ..... Return to Sub-menu
2030 '
2040 *PRO.END ' ..... End routine
2050 COM(1) OFF:CLOSE ' ..... Close communications port
2060 CONSOLE 0,25,0,1:CLS 3
2070 END
2080 '
2090 *SEND ' ..... Send command routine
2100 SND$=CHR$(&H1B)+MID$(SEND$,6)
2110 PRINT #1,SND$
2120 RETURN
2130 '
2140 *RCV ' ..... Receive interrupt routine
2150 IF LOC(1)=0 THEN GOTO *NORCV
2160 SX=POS(0):SY=CSRLIN
2170 LINE INPUT #1,RCV$
2180 LOCATE 0,RY:COLOR 0
2190 PRINT "[ESC]";MID$(RCV$,2)
2200 R.CODE$=MID$(RCV$,2,1)
2210 *ESC.Y ' ..... Notify screen number
2220 IF R.CODE$<>"Y" THEN GOTO *ESC.E
2230 PRINT "Screen Number : ";VAL("&H"+MID$(RCV$,3,4))
2240 PRINT:GOTO *RCV.END
2250 *ESC.E ' ..... Notify 4-digit number
2260 IF R.CODE$<>"E" THEN GOTO *ESC.F
2270 PRINT "Numeral table entry # : ";VAL("&H"+MID$(RCV$,3,3))
2280 PRINT "Input decimal value";VAL(MID$(RCV$,6,4))
2290 PRINT:GOTO *RCV.END
2300 *ESC.F ' ..... Notify 8-digit number
2310 IF R.CODE$<>"F" THEN GOTO *ESC.H
2320 PRINT "Numeral table entry # : ";VAL("&H"+MID$(RCV$,3,3))
2330 IF MID$(RCV$,6,1)="F" THEN NN=0-VAL(MID$(RCV$,7,7)) ELSE NN=VAL(MID$(RCV$,6,8))
2340 PRINT "Input decimal value : ";NN
2350 PRINT:GOTO *RCV.END

```

```

2360 *ESC.H ' ..... Notify touch switch (number)
2370 IF R.CODE$<>"H" THEN GOTO *ESC.J
2380 PRINT "Pressed touch switch number : ";VAL("&H"+MID$(RCV$,3,3))
2390 PRINT:GOTO *RCV.END
2400 *ESC.J ' ..... Notify touch switch (bit)
2410 IF R.CODE$<>"J" THEN GOTO *ESC.S
2420 PRINT "Pressed touch switch number : ";
2430 TS=0
2440 FOR I=0 TO 13
2450   S=VAL("&H"+MID$(RCV$,3+I*2,2))
2460   FOR J=0 TO 7
2470     IF (S MOD 2)=1 THEN PRINT TS;" ";
2480     S=S¥2:TS=TS+1
2490   NEXT J,I
2500 PRINT:PRINT:GOTO *RCV.END
2510 *ESC.S ' ..... Notify lamp and touch switch status
2520 IF R.CODE$<>"S" THEN GOTO *RCV.ERR
2530 PRINT "Lamp/touch switch number : ";VAL("&H"+MID$(RCV$,4,2))
2540 M=VAL(MID$(RCV$,3,1))
2550 IF M=0 THEN M$="OFF" ELSE IF M=1 THEN M$="ON" ELSE M$="INVERSE"
2560 PRINT "Display status          : ";M$
2570 PRINT:GOTO *RCV.END
2580 '
2590 *RCV.ERR
2600 PRINT "Receive data error"
2610 PRINT
2620 '
2630 *RCV.END
2640 RY=CSRLIN
2650 LOCATE SX,SY
2660 *NORCV
2670 RETURN
2680 '
2690 *ESC.0 ' ..... Display specified screen
2700 LOCATE 43,0:INPUT "Screen number : ",M
2710 M$=RIGHT$("000"+HEX$(M),4)
2720 SEND$=SEND$+M$
2730 RETURN
2740 *ESC.X ' ..... Screen # enquiry
2750 RETURN
2760 *ESC.B ' ..... Write character screen
2770 LOCATE 43,0:INPUT "Character-screen memory table entry number : ",M
2780 LOCATE 43,1:PRINT "Write character string (32 CHARACTERS MAX.) -->"
2790 LOCATE 43,2:INPUT C$
2800 M$=RIGHT$("0"+HEX$(M),2)
2810 C$=LEFT$(C$,32):L$=RIGHT$("0"+HEX$(LEN(C$)),2)

```

```

2820 SEND$=SEND$+L$+M$+C$
2830 RETURN
2840 *ESC.C ' ..... Write 4-digit number
2850 LOCATE 43,0:INPUT "Numeral table entry #: ",M
2860 *NAGAIN
2870 LOCATE 43,1:INPUT "Write 1 to 4-digit number : ",N%
2880 IF N%<-999 OR N%>9999 THEN GOTO *NAGAIN
2890 IF N%<0 THEN S$="F" ELSE S$=""
2900 M$=RIGHT$("00"+HEX$(M),3)
2910 N%=ABS(N%)
2920 N$=STR$(N%):N$=RIGHT$(N$,LEN(N$)-1)
2930 IF S$<>"F" THEN N$=RIGHT$("000"+N$=RIGHT$("00"+N$,3)
2940 SEND$=SEND$+M$+S$+N$
2950 RETURN
2960 *ESC.D ' ..... Write 8-digit number
2970 LOCATE 43,0:INPUT "Numeral table entry #: ",M
2980 *N8AGAIN
2990 LOCATE 43,1:PRINT SPACE$(36)
3000 LOCATE 43,1:INPUT "Write 1 to 8-digit number : ",N#
3010 N#=INT(N#)
3020 IF N#<-9999999# OR N#>99999999# THEN GOTO *N8AGAIN
3030 IF N#<0 THEN S$="F" ELSE S$=""
3040 M$=RIGHT$("00"+HEX$(M),3)
3050 N#=ABS(N#)
3060 N$=STR$(N#):N$=RIGHT$(N$,LEN(N$)-1)
3070 IF S$<>"F" THEN N$=RIGHT$("0000000"+N$,8) ELSE N$=RIGHT$("000000"+N$,7)
3080 SEND$=SEND$+M$+S$+N$
3090 RETURN
3100 *ESC.2F ' ..... Copy memory table entry
3110 LOCATE 43,0:INPUT "0: character string/1 : number ",M$
3120 IF M$<>"0"AND M$<>"1" THEN *ESC.2F
3130 LOCATE 43,1:INPUT "Copy source memory table entry number : ",S%
3140 LOCATE 43,2:INPUT "Copy destination memory table entry number : ",D%
3150 S$=STR$(S%):S$=RIGHT$(S$,LEN(S$)-1):S$=RIGHT$("00"+S$,3)
3160 D$=STR$(D%):D$=RIGHT$(D$,LEN(D$)-1):D$=RIGHT$("00"+D$,3)
3170 SEND$=SEND$+M$+S$+D$
3180 RETURN
3190 *ESC.K ' ..... Display lamps and touch switches (bits)
3200 FOR I=0 TO 31:TS.B(I)=-1:NEXT I
3210 FOR I=0 TO 31
3220   LOCATE 65-(I MOD 8)*3,I#8:PRINT RIGHT$(STR$(I),2)
3230 NEXT I
3240 LOCATE 43,5:PRINT "Input # : Inverse Input : Run input 99 : Execute"
3250 *ESC.K.2
3260 COLOR 0:LOCATE 43,6:PRINT SPACE$(36)
3270 LOCATE 43,6:INPUT "Lamp/touch switch number : ";N

```

```
3280 IF N=99 THEN GOTO *ESC.K.3
3290 IF N<0 OR N>31 THEN GOTO *ESC.K.2
3300 TS.B(N)=TS.B(N)*(-1)
3310 COLOR 2+TS.B(N)*2
3320 LOCATE 65-(N MOD 8)*3,N#8:PRINT RIGHT$(STR$(N),2)
3330 GOTO *ESC.K.2
3340 *ESC.K.3
3350 FOR I=0 TO 3
3360   M=0
3370   FOR J=0 TO 7
3380     IF TS.B(I*8+J)=1 THEN M=M+2^J
3390   NEXT J
3400   SEND$=SEND$+RIGHT$("0"+HEX$(M),2)
3410 NEXT I
3420 COLOR 0
3430 RETURN
3440 *ESC.Q ' . . . . . Display lamps and touch switches (number)
3450 LOCATE 43,0:PRINT "Display specification"
3460 LOCATE 43,1:PRINT " 0 : OFF"
3470 LOCATE 43,2:PRINT " 1 : ON"
3480 LOCATE 43,3:PRINT " 2 : Inverse flashing (lamps only)"
3490 LOCATE 43,4:PRINT " 3 : All ON"
3500 *QAGAIN
3510 LOCATE 43,5:INPUT " : ",M$
3520 IF M$<>"0" AND M$<>"1" AND M$<>"2" AND M$<>"3" THEN GOTO *QAGAIN
3530 LOCATE 43,6:INPUT "Lamp/touch switch number : ",N
3540 N$=RIGHT$("00"+HEX$(N),2)
3550 SEND$=SEND$+M$+N$
3560 RETURN
3570 *ESC.R ' . . . . . Enquire lamp and touch switch status
3580 LOCATE 43,0:INPUT "Lamp/touch switch number : ",N
3590 N$=RIGHT$("00"+HEX$(N),2)
3600 SEND$=SEND$+N$
3610 RETURN
3620 *ESC.U ' . . . . . Disable inputs
3630 SEND$=SEND$+"0"
3640 RETURN
3650 *ESC.V ' . . . . . Enables inputs
3660 SEND$=SEND$+"0"
3670 RETURN
3680 *ESC.P ' . . . . . Display screen
3690 LOCATE 43,0:PRINT "Controlled item"
3700 LOCATE 43,1:PRINT " 0 : Display"
3710 LOCATE 43,2:PRINT " 1 : No display"
3720 *PAGAIN
3730 LOCATE 43,3:INPUT " : ",M$
```

```
3740 IF M$<>"0" AND M$<>"1" THEN GOTO *PAGAIN
3750 SEND$=SEND$+M$
3760 RETURN
3770 *ESC.T ' ..... Buzzer control
3780 LOCATE 43,0:PRINT "Controlled item"
3790 LOCATE 43,1:PRINT " 0 : Stop buzzer"
3800 LOCATE 43,2:PRINT " 1 : Continuous buzzer"
3810 LOCATE 43,3:PRINT " 2 : Intermittent buzzer"
3820 *TAGAIN
3830 LOCATE 43,4:INPUT " : ",M$
3840 IF M$<>"0" AND M$<>"1" AND M$<>"2" THEN GOTO *TAGAIN
3850 SEND$=SEND$+M$
3860 RETURN
3870 *ESC.W ' ..... System menu display
3880 LOCATE 43,0:PRINT "Controlled item"
3890 LOCATE 43,1:PRINT " 0:MENU TRANSFER ENABLE"
3900 LOCATE 43,2:PRINT " 1:MENU TRANSFER DISABLE"
3910 *WAGAIN
3920 LOCATE 43,3:INPUT " : ",M$
3930 IF M$<>"0" AND M$<>"1" THEN GOTO *WAGAIN
3940 SEND$=SEND$+M$
3950 RETURN
3960 '
3970 *ESC.26 ' ..... Clear screen
3980 RETURN
3990 *ESC.29 ' ..... Specify 1-byte character
4000 LOCATE 43,0:PRINT "Character specify size"
4010 LOCATE 43,1:PRINT " 0 : NORMAL SIZE (16x8)"
4020 LOCATE 43,2:PRINT " 1 : HALF SIZE (8x8)"
4030 *E26AGAIN
4040 LOCATE 43,3:INPUT " : ",M$
4050 IF M$<>"0" AND M$<>"1" THEN GOTO *E26AGAIN
4060 SEND$=SEND$+M$
4070 RETURN
4080 *ESC.2A ' ..... Specify character enlargement
4090 LOCATE 43,0:PRINT "Specify character enlargement"
4100 LOCATE 43,1:PRINT " 0:NO ENLARGEMENT"
4110 LOCATE 43,2:PRINT " 1:ENLARGE HEIGHT"
4120 LOCATE 43,3:PRINT " 2:ENLARGE WIDTH"
4130 LOCATE 43,4:PRINT " 3:2X2 ENLARGEMENT"
4140 LOCATE 43,5:PRINT " 4:3X3 TIMES ENLARGEMENT"
4150 LOCATE 43,6:PRINT " 5:4X4 TIMES ENLARGEMENT"
4160 *E2AAGAIN
4170 LOCATE 43,7:INPUT " : ",M$
4180 IF M$="0" OR M$="1" OR M$="2" THEN GOTO *E2ASEND
4190 IF M$="3" OR M$="4" OR M$="5" THEN GOTO *E2ASEND
```

```

4200 GOTO *E2AAGAIN
4210 *E2ASEND
4220 SEND$=SEND$+M$
4230 RETURN
4240 *ESC.21 ' ..... Normal display
4250 RETURN
4260 *ESC.22 ' ..... Set inverse display
4270 RETURN
4280 *ESC.23 ' ..... End inverse display
4290 RETURN
4300 *ESC.24 ' ..... Set flashing display
4310 RETURN
4320 *ESC.25 ' ..... End flashing display
4330 RETURN
4340 *ESC.2B ' ..... Set cursor position
4350 *E2B.X
4360 LOCATE 43,0:PRINT SPACE$(36)
4370 LOCATE 43,0:INPUT "X COORDINATE(000-255)",BX
4380 IF BX>639 OR BX<0 THEN *E2B.X
4390 *E2B.Y
4400 LOCATE 43,1:PRINT SPACE$(36)
4410 LOCATE 43,1:INPUT "Y COORDINATE(000-127)",BY
4420 IF BY>255 OR BY<0 THEN *E2B.Y
4430 BX$=STR$(BX):BX$=RIGHT$(BX$,LEN(BX$)-1):BX$=RIGHT$("00"+BX$,3)
4440 BY$=STR$(BY):BY$=RIGHT$(BY$,LEN(BY$)-1):BY$=RIGHT$("00"+BY$,3)
4450 SEND$=SEND$+BX$+BY$
4460 RETURN
4470 *ESC.4 ' ..... Specify Displayed Characters
4480 LOCATE 43,0:PRINT "Write character string (32 CHARACTERS MAX.) -->|"
4490 LOCATE 43,1:INPUT C$
4500 C$=LEFT$(C$,32):L$=RIGHT$("0"+HEX$(LEN(C$)),2)
4510 SEND$=SEND$+L$+C$
4520 RETURN
4530 *ESC.7 ' ..... Draw Polyline
4540 LN=0:SL$=""
4550 *E7.X
4560 LOCATE 41,8:PRINT SPACE$(38)
4570 LOCATE 41,9:PRINT SPACE$(38)
4580 LOCATE 41,8:INPUT "X COORDINATE(END AT 999) : ",LX
4590 IF LX=999 THEN *E7.E
4600 IF LX<0 OR LX>255 THEN GOTO *E7.X
4610 *E7.Y
4620 LOCATE 41,9:PRINT SPACE$(38)
4630 LOCATE 41,9:INPUT "Y COORDINATE : ",LY
4640 IF LY<0 OR LY>127 THEN GOTO *E7.Y
4650 LX$=STR$(LX):LX$=RIGHT$(LX$,LEN(LX$)-1):LX$=RIGHT$("00"+LX$,3)

```

```

4660 LY$=STR$(LY):LY$=RIGHT$(LY$,LEN(LY$)-1):LY$=RIGHT$("00"+LY$,3)
4670 LOCATE 39+(LN MOD 5)*8,LN#5:PRINT LX$;" ";LY$;
4680 SL$=SL$+LX$+LY$
4690 LN=LN+1
4700 IF LN<40 THEN GOTO *E7.X
4710 *E7.E
4720 LN$=HEX$(LN-1):LN$=RIGHT$("0"+LN$,2)
4730 SEND$=SEND$+LN$+SL$
4740 RETURN
4750 *ESC.8 ' ..... Draw circle
4760 *E8.X
4770 LOCATE 43,0:PRINT SPACE$(36)
4780 LOCATE 43,0:INPUT "X COORDINATE OF CENTER OF CIRCLE : ",CX
4790 IF CX>255 OR CX<0 THEN *E8.X
4800 *E8.Y
4810 LOCATE 43,1:PRINT SPACE$(36)
4820 LOCATE 43,1:INPUT "Y COORDINATE OF CENTER OF CIRCLE : ",CY
4830 IF CY>127 OR CY<0 THEN *E8.Y
4840 *E8.R
4850 LOCATE 43,2:PRINT SPACE$(36)
4860 LOCATE 43,2:INPUT "?????#####",CR
4870 IF CR>63 OR CR<0 THEN *E8.R
4880 CX$=STR$(CX):CX$=RIGHT$(CX$,LEN(CX$)-1):CX$=RIGHT$("00"+CX$,3)
4890 CY$=STR$(CY):CY$=RIGHT$(CY$,LEN(CY$)-1):CY$=RIGHT$("00"+CY$,3)
4900 CR$=STR$(CR):CR$=RIGHT$(CR$,LEN(CR$)-1):CR$=RIGHT$("00"+CR$,3)
4910 SEND$=SEND$+CX$+CY$+CR$
4920 RETURN
4930 '
4940 *SELECT ' ..... Item selection routine
4950 IF LV=0 THEN LX=3 ELSE LX=LV*20+1
4960 IF LV=0 THEN LY=1 ELSE LY=0
5970 COLOR 4:LOCATE LX,LY:PRINT CMND$(SECT.NO,1,0)
5980 COLOR 0
5990 FOR I=2 TO CMND(SECT.NO)
5000   IF LV=0 AND I<=5   THEN LY=I
5010   IF LV=0 AND I>5   THEN LY=I+1
5020   IF LV=1           THEN LY=I-1
5030   LOCATE LX,LY:PRINT CMND$(SECT.NO,I,0)
5040 NEXT I
5050 *KY.IN
5060 A$=INKEY$:IF A$=""   THEN GOTO *KY.IN
5070 IF A$<>CHR$(&H1B)   THEN GOTO *KY1
5080   COLOR 0
5090   FOR I=1 TO CMND(SECT.NO)
5100     IF LV=0 AND I<=5 THEN LY=I
5110     IF LV=0 AND I>5  THEN LY=I+1

```



```
5120     IF LV=1                THEN LY=I-1
5130     LOCATE LX,LY:PRINT SPACE$(20)
5140     NEXT I
5150     SEL.NO=0
5160     GOTO *SEL.RET
5170     *KY1
5180     IF A$<>CHR$(&H1E) AND A$<>CHR$(&H1F) THEN GOTO *KY2
5190     IF LV=0 AND SEL.NO<=5  THEN LY=SEL.NO
5200     IF LV=0 AND SEL.NO>5   THEN LY=SEL.NO+1
5210     IF LV=1                THEN LY=SEL.NO-1
5220     COLOR 0:LOCATE LX,LY:PRINT CMND$(SECT.NO,SEL.NO,0)
5230     IF A$=CHR$(&H1E)      THEN SEL.NO=SEL.NO-1 ELSE SEL.NO=SEL.NO+1
5240     IF SEL.NO=0           THEN SEL.NO=CMND(SECT.NO)
5250     IF SEL.NO>CMND(SECT.NO) THEN SEL.NO=1
5260     IF LV=0 AND SEL.NO<=5  THEN LY=SEL.NO
5270     IF LV=0 AND SEL.NO>5   THEN LY=SEL.NO+1
5280     IF LV=1                THEN LY=SEL.NO-1
5290     COLOR 4:LOCATE LX,LY:PRINT CMND$(SECT.NO,SEL.NO,0)
5300     GOTO *KY.IN
5310     *KY2
5320     IF A$<>CHR$(&HD) THEN GOTO *KY.IN
5330     *SEL.RET
5340     COLOR 0
5350     RETURN
5360     DATA "SCREEN CONTROL","MEMORY TABLE OPERATION","LAMP, TOUCH SWITCH OPERATION"
5370     DATA "TOUCH SWITCH INPUT","SYSTEM CONTROL","CHARACTER SIZE"
5380     DATA "CHARACTER DISPLAY ATTRIBUTE","CHARACTER-STRING DISPLAY","FIGURE DISPLAY"
5390     DATA 2
5400     DATA "Display specified screen","[ESC]0"
5410     DATA "Request screen number","[ESC]X"
5420     DATA 4
5430     DATA "Write character-string memory table","[ESC]B"
5440     DATA "4-digit write numeral table","[ESC]C"
5450     DATA "8-digit write numeral table","[ESC]D"
5460     DATA "Copy memory table","[ESC]/"
5470     DATA 3
5480     DATA "Lamp and touch switch display (bit specification)","[ESC]K"
5490     DATA "Lamp and touch switch display (address specification)","[ESC]Q"
5500     DATA "Lamp and touch switch display status enquiry","[ESC]R"
5510     DATA 2
5520     DATA "Touch switch disable","[ESC]U"
5530     DATA "Touch switch enable","[ESC]V"
5540     DATA 3
5550     DATA "Screen display control","[ESC]P"
5560     DATA "Buzzer control","[ESC]T"
5570     DATA "Mode Transition Enable","[ESC]W"
```

```
5580 DATA 3
5590 DATA "Clear screen", "[ESC]&"
5600 DATA "Character specify size", "[ESC])"
5610 DATA "Specify character enlargement", "[ESC]*"
5620 DATA 5
5630 DATA "Normal display", "[ESC]!"
5640 DATA "Set inverse display", "@@@@@@"
5650 DATA "End inverse display", "[ESC]#"
5660 DATA "Set flashing display", "[ESC]$"
5670 DATA "End flashing display", "[ESC]%"
5680 DATA 2
5690 DATA "Set cursor position", "[ESC]+"
5700 DATA "Specify displayed characters", "[ESC]4"
5710 DATA 2
5720 DATA "Draw polyline", "[ESC]7"
5730 DATA "Draw circle", "[ESC]8"
```



# SECTION 7

## Troubleshooting and Maintenance

This section describes the action to take when NT20 errors occur, and how to carry out maintenance and inspections to prevent the occurrence of errors.

7-1	Hardware Faults . . . . .	248
7-2	Responding to Displayed Error Messages . . . . .	249
7-2-1	Errors Occurring When the Power Is Turned ON . . . . .	249
7-2-2	Errors Occurring during Operation. . . . .	249
7-2-3	Errors Occurring on Screen Data Initialization . . . . .	249
7-2-4	Errors Occurring on Resource Transmit Mode. . . . .	250
7-2-5	Errors Occurring on System Program Transmit Mode. . . . .	250
7-2-6	Communications Errors . . . . .	251
7-3	Maintenance of the NT20 . . . . .	253
7-4	Inspection and Cleaning . . . . .	253

## 7-1 Hardware Faults

When a fault relating to the operation of the NT20 occurs, find the symptoms in the table below and respond by following the corresponding “Remedy” indicated in the table.

- Note**
1. Confirm system safety before turning the power ON/OFF or resetting.
  2. Do not disassemble the PT for repair or modification.

NT20 Symptoms	Cause	Remedy
Nothing is displayed on the screen	Power is not being supplied.	Check the connections and make sure that power is supplied correctly. (Refer to 2-2-3 Power Supply Connection, page 23.)
	Power supply fuse has blown	Contact your OMRON service center.
	Screen #0 has been read at the host.	This is not an error. Change the screen number. (Refer to 4-3 Screen Display, page 140.)
Communications with the Support Tool not possible.	The Transmit Mode has not been established.	Display the system menu and select the Transmit Mode. (Refer to 3-6 Registering the Screen Data, page 102.)
	Not connected to the Support Tool.	Check the installation of the connector cable. (Refer to 2-4 Connecting the NT Support Tool, page 35.)
	The PT type/direct connection settings made at the Support Tool do not agree with the NT20.	Make the PT type setting and direct connection setting in the “PT Configuration” of the Support Tool agree with the NT20.
Cannot communicate with the PLC/Host.	Memory switch settings do not match.	Check the communications setting in the “Memory Switch” menu of the Maintenance Mode, and match the PLC and NT20 settings. (Refer to 3-5 Setting the Conditions of Communications with the Host by Using the Memory Switches, page 91.)
	NT20 and PLC are not correctly connected.	Check that the type, length and installation of the connector cable match the specifications. (Refer to 2-4 Connecting the NT Support Tool, page 35, 2-6 Connecting to the RS-232C Port at the Host, page 44.)
	When NT link (1:N), there is unit number duplication.	Set again with no duplication.
	Power not supplied to the NT20, PLC, or host	Check the power supply.
Buzzer sounds, RUN LED is OFF.	Malfunction due to external noise.	Distance the communications cable from the source of the noise and insert a noise filter in the power supply line.
Touch panel does not respond	Malfunction due to external noise	Distance the communications cable from the source of the noise and insert a noise filter in the power supply line.
	Touch panel is broken.	Check the touch panel by performing the touch panel test in the I/O check in the maintenance mode.
PLC mode changes to monitor mode.	The NT20 changes the mode during host link communications.	This is normal with the NT20 specification. When using a PLC that can also be connected using the NT link, connect it with the NT link (the mode is not changed when using the NT link).

## 7-2 Responding to Displayed Error Messages

When the NT20 displays an error message, find the corresponding symptoms in the appropriate table below and respond by following the “Remedy” indicated in the table.

### 7-2-1 Errors Occurring When the Power Is Turned ON

The table below shows the errors that can occur when the power supply to the NT20 is turned ON, and their remedies.

Message	Cause	Remedy
Screen Data Corrupted	There is an error in the registered screen data.	After initializing the screen data memory in the Maintenance Mode, transmit the screen data once more with the Support Tool.
Mark Data Corrupted	There is an error in the registered mark data.	After initializing the screen data memory in the Maintenance Mode, transmit the screen data once more using the Support Tool.
No direct information is set!	The allocated words for the PT status control area and PT status notify area have not been set.	Use the Support Tool to set the head words of the PT status control area and PT status notify area, and transmit the screen data again.
	There is no screen data.	Transmit screen data from the Support Tool.

### 7-2-2 Errors Occurring during Operation

The table below shows the errors that can occur during operation of the NT20, and their remedies.

Message	Cause	Remedy
Setting Error	Bits or words allocated to the PLC memory cannot be found in the screen data.	Check the memory area in the PLC used and correct the bit and word allocations in the screen data.
QQ command is not available	The PLC cannot be connected to the NT20.	Select a type of PLC that can be connected to the NT20.

### 7-2-3 Errors Occurring on Screen Data Initialization

The table below shows the errors that can occur when data is written to the NT20 screen data memory, and their remedies.

Message	Cause	Remedy
Initialization Error	Hardware fault or screen data memory life reached	If the same message is displayed even after executing screen data memory initialization or screen data transmission several times, contact your OMRON service center.

### 7-2-4 Errors Occurring on Resource Transmit Mode

The table below shows the errors that can occur when erasing resource, downloading resource or when NT20 is power on, and their remedies.

Message	Cause	Remedy
Erasing failed.	Hardware fault or resource memory life reached	Push the reset switch and erase again. If the same message is displayed even after executing erase several times, contact your OMRON service center.
Downloading failed.	Noise caused data corruption during communications	Push the reset switch and download again. Use noise-resistant cable if communications occurs in an environment with high levels of noise.
Resource Error!	Resource is missing or fragmentary. Checksum of Resource is wrong. There are any two items unmatched among system program, Font Data and System Information Data.	Turn ON the DIP switch 2-5 and push the reset switch to download resource.

### 7-2-5 Errors Occurring on System Program Transmit Mode

The table below shows the errors that can occur when erasing system program, downloading system program or when NT20 is power on, and their remedies.

Message	Cause	Remedy
Erasing failed.	Hardware fault or resource memory life reached	Push the reset switch and erase again.
Communications Error Time Out	The connectors or the connecting cable have become disconnected.	Reconnect the cable. Push the reset switch and download again.
System program error!	<p>The power to the NT20 is switched off, or the NT20 is reset, during transfer.</p> <p>The power to the personal computer that is running the system transfer tool is switched off, or the personal computer is reset, during transfer.</p> <p>The cable connecting the personal computer running the system transfer tool and the NT20 becomes disconnected or sustains a wire breakage during transfer.</p> <p>Transfer is terminated by pressing any two of the function keys on the panel of the NT20.</p> <p>Transfer is terminated by pressing the ESC key of the personal computer running the system transfer tool.</p>	Please download system program again.

### 7-2-6 Communications Errors

This section describes the errors relating to communications with the PLC/Host that can occur during operation, and their remedies.

- Operation When a Communications Error Occurs

When a communications error occurs, the error message is displayed at the NT20, and the buzzer sounds. Error messages are displayed when the “Automatic Reset” memory switch is not set.

Some error messages are displayed even if the “Automatic Reset” memory switch is set.

- Procedure When a Communications Error Occurs

When an error message is displayed, press the [EXIT] touch switch displayed on the screen. The screen display will return to the RUN mode.

- Display of Communications Errors

As shown below, communications errors are displayed in the center of the screen, together with a classification indicating whether they are receive or send errors.

#### Screen When an Error Has Occurred while Receiving

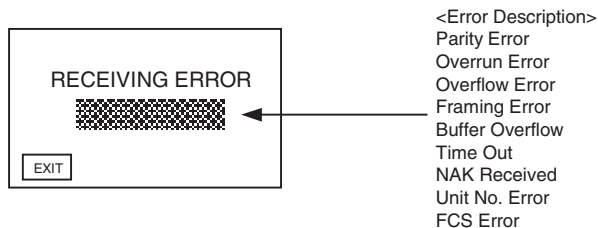

#### Screen When an Error Has Occurred while Sending

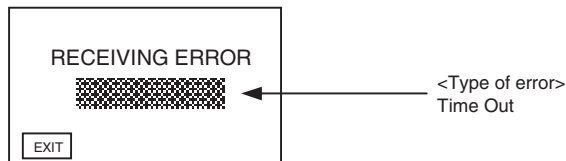

Message	Cause	Remedy
(ACIA) Parity Error Framing Error Overflow Error Overrun	Communications parameters/conditions of communications set incorrectly.	Check whether the parity bit, frame length, baud rate, stop bit length, and flow control settings of the PLC match the settings of the NT20.
	Noise caused data corruption during communications.	Use a noise-resistant cable if communications occurs in an environment with high levels of noise.
	The connectors of the connecting cable are not connected correctly.	Reconnect the cable.
Buffer Overflow (NT20-ST128 only)	The NT20 receive buffer is full.	Lengthen the command transmission intervals. If this error occurs frequently, set flow control for communications.



<b>Message</b>	<b>Cause</b>	<b>Remedy</b>
Time Out	The connectors of the connecting cable have become disconnected.	Reconnect the cable.
	The PLC is stopped.	Make sure the PLC is able to communicate with the NT20.
	During transmission of one command, a time lapse exceeding 5 seconds is detected.	Confirm the proper command length. Reconnect the cable.
NAK Received (end code simultaneously displayed)	Noise caused data corruption during communications.	Use a noise-resistant cable if communications occurs in an environment with high levels of noise.
	Error returned by host.	Check the end code by referring to the PLC operation manual.
Unit No. Error	The unit # does not match that set on the PLC.	Set the PLC unit # to "0".
	The PLC is transmitting incorrect data.	Check PLC operation.
	Noise caused data corruption during communications.	Use a noise-resistant cable if communications occurs in an environment with high levels of noise.
FCS Error	The PLC is transmitting incorrect data.	Check PLC operation.
	Noise caused data corruption during communications.	Use a noise-resistant cable if communications occurs in an environment with high levels of noise.

## 7-3 Maintenance of the NT20

Carry out maintenance work in order to ensure that the NT20 is always used in its optimum condition.

 **WARNING** Do not attempt to take the PLC apart and do not touch any internal parts while the power is being supplied. Doing either of these may result in electrical shock.

### Spare PT

It is advisable to have a spare NT20 available to minimize system downtime in the event of an NT20 failure or if the screen display becomes difficult to read due to deterioration of the display unit.

### Backlight

The backlight must be replaced when the brightness of the display backlight dims and the display becomes difficult to see. The backlight cannot be replaced by the user.

Contact your nearest OMRON representative.

## 7-4 Inspection and Cleaning

Clean and inspect the NT20 regularly to ensure that it is always used in its optimum condition.

### Cleaning Method

If the display is dirty the screen is difficult to see. Clean the screen from time to time as follows.

- In daily cleaning, wipe the display with a soft dry cloth.
- If the soiling cannot be removed with a dry cloth, wet the cloth with water, wring it out well and wipe the display with it.
- If rubber or vinyl products, tape, etc. are left stuck to the display for long periods they will cause staining. If such items are stuck to the display, remove them during cleaning.

**Note** Never use volatile solvents such as benzene or thinners, or dusters.

### Inspection Method

In normal environments, inspect the NT20 at intervals of between 6 months and a year. In environments that are extremely hot and humid, or very dusty environments, shorten the inspection interval.

- Items Required for Inspection

Prepare the following items before starting the inspection.

- The tools supplied with the NT20
- Screwdrivers (Phillips, flat-head)
- Tester (or digital voltmeter)
- Industrial alcohol
- 100% cotton cloth
- Hygrometer (required in some cases)
- Thermometer (required in some cases)
- Synchroscope (required in some cases)
- Pen-writing oscilloscope (required in some cases)

- Faulty Display Pixels

Although the LCD panel has been manufactured with extremely high-level technology, there can sometimes be pixels that will not light or that will be lit constantly. These are characteristic of LCD panels and are not an indication of a faulty display. Please understand that, although we are constantly striving to keep these pixels to a minimum, it is not possible with present technology to eliminate them completely.

- Points Inspected

Inspect the following points to determine if there is any divergence from the stated criteria. If there is, either improve the surrounding environment so that the values fall within the stated range, or adjust the NT20.

Point Inspected	Inspection Details	Criterion	Inspection Instrument
Power supply voltage	Fluctuation in power supply terminal voltage	Permissible voltage fluctuation range (24 VDC – 15% +15%)	Tester
Ambient environmental conditions	Ambient temperature (temperature in the operation panel)	0 to 50°C	Thermometer
	Ambient humidity (humidity in the operation panel)	35% to 85%	Hygrometer
	Presence/absence of dust	Dust must not be settled	Visual inspection
Mounting conditions	Looseness of mounting brackets etc.	To be no looseness	Accessory tools
	Connector connections of connecting cable	To be fully inserted and locked, with no looseness	
	Looseness of screws in external wiring	To be no looseness	Phillips screwdriver
	Conditions of external connecting cables	Faults such as incipient disconnections.	Visual inspection
External appearance	Peeling of front sheet	Front sheet must not show any signs of peeling.	Visual inspection

**Note**

- (1) Do not attempt to disassemble the NT20 for repair or modification.
- (2) The disposal of the NT20 may be regulated by national or local authorities. Dispose of them according to the laws and regulations of the relevant country and local authority.
- (3) When replacing the NT20 after discovering a fault during inspections, note the following points:
  - Be sure to switch the power OFF before replacement.
  - After replacement, check that the new NT20 is not subject to the same error.
  - If a faulty unit is returned for repairs, write as detailed a description of the fault as possible and send this description together with the unit to the OMRON address indicated on the back cover of this book.

# Appendix A

## Specifications

### General Specifications

Item	Specification
Power supply voltage	24 VDC
Allowable power supply voltage range	20.4 VDC to 27.6 VDC (24 VDC -15% +15%)
Allowable momentary power interruption time	Not specified.
Power consumption	10 W max.
Ambient operating temperature	0 to 50°C (with no freezing)
Storage temperature	-20 to 70°C
Ambient operating humidity	35% to 85% at 0 to 40°C (with no condensation) 35% to 50% at 40 to 50°C (with no condensation)
Ambient storage humidity	35% to 85% at -20 to 40°C (with no condensation) 35% to 50% at 40 to 50°C (with no condensation) 35% to 45% at 50 to 70°C (with no condensation)
Operating environment	No corrosive gases.
Noise immunity	Based on IEC 61000-4-4: 2 kV (power line)
Vibration resistance (during operation)	5 to 9 Hz with 3.5-mm single amplitude, 9 to 150 Hz with 9.8-m/s <sup>2</sup> acceleration for 10 times (1 octave/min) in each of X, Y and Z directions
Shock resistance (during operation)	147 m/s <sup>2</sup> , 3 times in each of X, Y and Z directions
Dimensions (mm)	190 x 108 x 53.5 mm (W x H x D)
Panel cutout dimensions	178.5 <sup>+0.5</sup> / <sub>0</sub> x 98.5 <sup>+0.5</sup> / <sub>0</sub> mm (H x V), Panel thickness: 1.6 to 4.8 mm
Weight	0.7 kg max.
Degree of protection	Front panel operating section: Equivalent to oil-resistant IP65 and equivalent to NEMA4 (See note 2.)
Applicable standards	UL 1604 Class 1 Division 2 and EC Directives

- Note** (1) The display quality (e.g., the contrast) will deteriorate at temperatures above 40°C. Also, response will be slower due to the characteristics of liquid crystals at low temperatures.
- (2) Do not use the PT in locations subject to long-term exposure to oil.

## Performance Specifications

### Display Specifications

Item	Specification	
Display panel (See note 1.)	Display device	Monochrome STN LCD (with backlight)
	Number of dots (resolution)	140 (128) vertical × 260 (256) horizontal, dot size: 0.42 mm Values in parentheses are the numbers of dots that can be used by the NT20 system program.
	Effective display area	66 (57.6) mm vertical × 120 (115.2) mm horizontal Values in parentheses are effective display area that can be used by the NT20 system program.
	Display mode	Blue mode
	View angle	Up: 40°, Down: 50°, Left: 35°, Right: 35°
	Life expectancy	50,000 hours minimum
	Contrast adjustment	The contrast can be adjusted with the contrast adjustment on the back of NT20.
Backlight (white cold cathode tube)	Life expectancy	50,000 hours minimum (See note 2.)
	Replacement	User must not replace the backlight.
	Brightness adjustment	Not provided.
	Automatic turn-off	Can be set to turn off in 10 minutes, 1 hour, or to remain ON.
Front-panel indicator	RUN	Lit green: Running normally and Memory Unit automatic transmission completed. Flashing green: Memory Unit automatic transmission being executed or Memory Unit automatic transmission error.

- Note** (1) There are sometimes faulty pixels in the touch panel but this does not indicate an error as long as the number of bright or dark pixels does not exceed the following limits.  
 4 total defects max. of the following size with no more than one per 20-mm square:  
 $0.2 \text{ mm} < (\text{short dia.} + \text{long dia.})/2 \leq 0.55 \text{ mm}$
- (2) Time taken for brightness to reduce to half at room temperature and humidity. This is a reference value only. The life expectancy will be radically reduced at low temperatures. For example, the life expectancy at 0°C or lower will be 10,000 hours (reference value).

### Panel Specifications

Item	Specification
Touch panel	Number of switches: 72 (6 vertically × 12 horizontally)
	Switch size: 9.14 mm horizontal × 9.18 mm vertical
	Input: Pressure-sensitive type
	Life expectancy: 1 million operations min.

## Display Capacity

Item		Specification	
		Host Link/NT Link C200H direct communications	RS-232C (NT20-ST128)
Display elements	Character displays	Fixed character data (character strings registered for each screen)	
	Character string displays	32 positions per screen	128 strings per file, 32 positions per screen
	Numeral displays (See note.)	50 positions per screen, 8-digit display	
	Graph displays (See note.)	50 per screen	
	Graphic displays	Can be displayed wherever required.	
	Lamps	128 per screen	256 strings per file max.
	Touch switches	72 per screen	256 strings per file max.
	Numeral settings (See note.)	Display of set numerical values 50 per screen, 8 digits each	
Screen types	Normal screen	Displays screens registered as normal.	
	Overlapping screens	A maximum of 8 registered screens can be displayed overlapped with each other.	
	Continuous screens	A maximum of 8 screens can be displayed sequentially by scrolling. (The screen can be changed by pressing the $\uparrow$ and $\downarrow$ touch switches)	
Screen attributes		Buzzer, numeral setting, backlight	Buzzer, numeral setting, backlight, bit input
Max. number of registered screens		495	
Screen registration method		Transfer screen data created using the Support Tool to the PT.	
Screen saving method (screen data memory)		Saved to flash memory (recording format unique to NT20)	

**Note** Number of numeral memory table entries that can be set (number used for numeral display + number used for graphs + number used for numeral settings)  $\leq$  128

## Display Element Specifications

Item	Specification
Display characters	Half-size characters (8 × 8 dots): Alphanumerics and symbols
	Normal characters (8 × 16 dots): Alphanumerics and symbols
	Marks (16 × 16 dots): User-defined pictographs
Enlargement function	Horizontal and vertical magnifications of double width, double height, 4x, 9x, and 16x
Smoothing processing	Enlarged characters up to 4x
Character display attributes	Normal, inverse, flashing, inverse flashing
Graphics	Continuous straight lines, circles

## Data Quantities

Item	Specification	
	Host Link/NT Link C200H direct communications	RS-232C (NT20-ST128)
Strings	128 strings comprising 32 characters each	
Numeral data	128 max. (8 digits each)	
Marks	64 marks	
Touch switches	No maximum restriction	256 strings per file max.
Lamps	No maximum restriction	256 strings per file max.

## Special Features

Item	Specification
Buzzer	Two types: Continuous sound and intermittent sound Setting: Set "Buzzer Sound" in the "Memory Switch" menu of the Maintenance Mode ON. If "ERR ON" is set the buzzer only sounds when an error occurs. ON: The buzzer sounds on designation from the PLC, when a screen with a buzzer-ON specification is called, or on display of an error screen such as for a receive error. OFF: The buzzer is turned off on designation from the PLC, by touch switch input, or when a screen without a buzzer-ON specification is displayed. Sound pressure: Min. 80 dB, average 87 dB (measured 10 cm from front face)
Maintenance functions	<ul style="list-style-type: none"> <li>• Self-test for memory, switches, etc.</li> <li>• Status setting confirmation for communications and other conditions.</li> <li>• Simple communications confirmation.</li> </ul>
Key input sound setting	0.2 second input sound when a touch switch is pressed Setting: Set "Key Sound" of the "Memory Switch" menu in the Maintenance mode ON.

**Note** The NT20 system program does not provide a battery backup function.

## Communications Specifications

### Host Link

Item	Specification
Communications standard	EIA RS-232C
Communications settings	Start-stop synchronization Baud rate: 9,600, 19,200, 38,400, 57,600, 115,200 bps Data length: 7 bits Stop bits: 2 bits Parity: Even
Connector	9-pin, D-SUB connector (female)
Number of units connected	1 to 1
Transmission distance	15 m max.

### NT Link (1:1)

Item	Specification
Communications standard	EIA RS-232C
Connector	9-pin D-SUB connector (female)
Number of units connected	1 to 1
Transmission distance	15 m max.

### NT Link (1:N)

Item	Specification
Communications standard	EIA RS-232C
Connector	9-pin D-SUB connector (female)
Number of units connected	1:1 to 8
Transmission distance	RS-232C cable: 2 m max. (*) RS-422A/485 cable: Total length 500 m (*)

(\*) When NT-AL001 used

### RS-232C (NT20-ST128)

Item	Specification
Communications standard	EIA RS-232C
Communications settings	Start-stop synchronization Baud rate: 2,400, 4,800, 9,600, 19,200 bps Data length: 7, 8 bits Stop bits: 1, 2 bits Parity: Even, Odd, None Flow control: RS/CS control XON/XOFF control None
Connector	9-pin D-SUB connector (female)
Number of units connected	1 to 1
Transmission distance	15 m max.





# Appendix B Dimensions

## Outside Dimensions

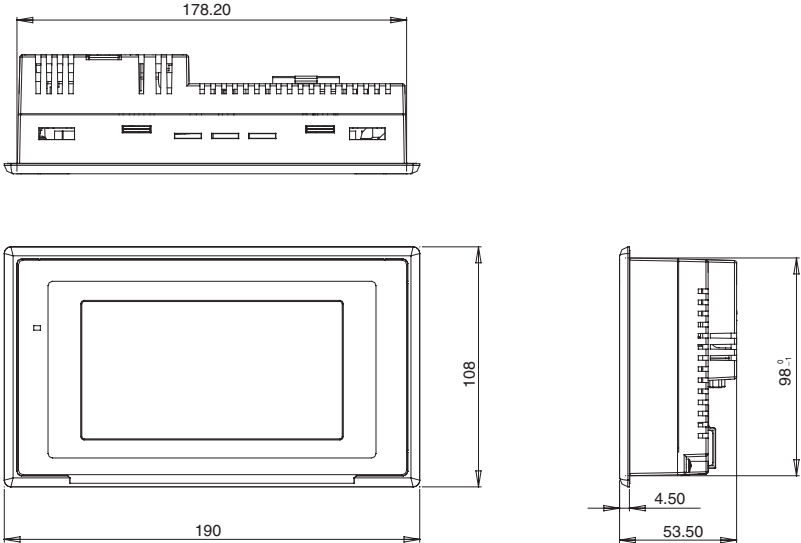

Unit: mm

## Installation Dimensions

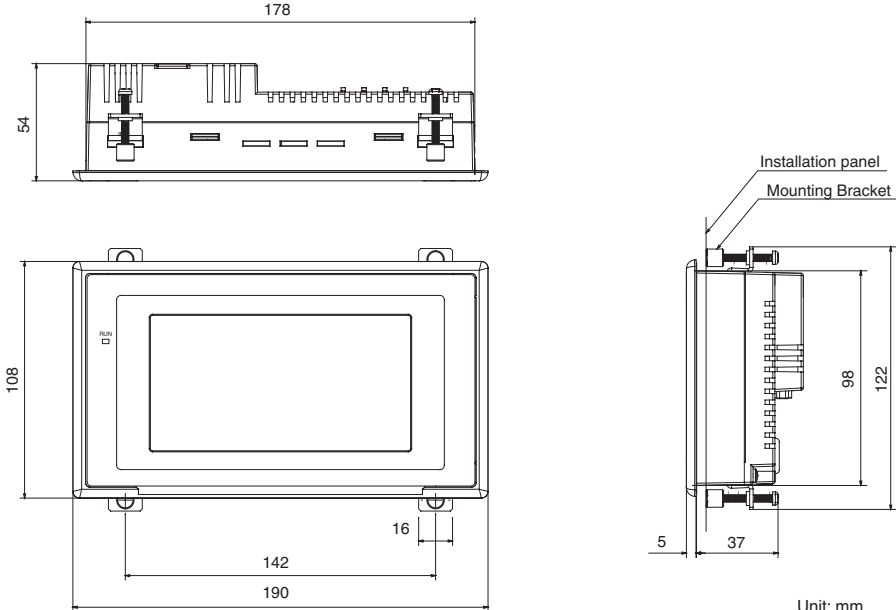

Unit: mm

Cable Connection Dimensions

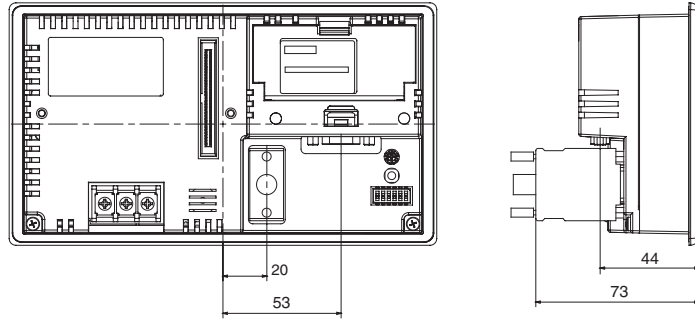

Unit: mm

Cable Connection Dimensions (with C200H Communications Interface Unit Mounted)

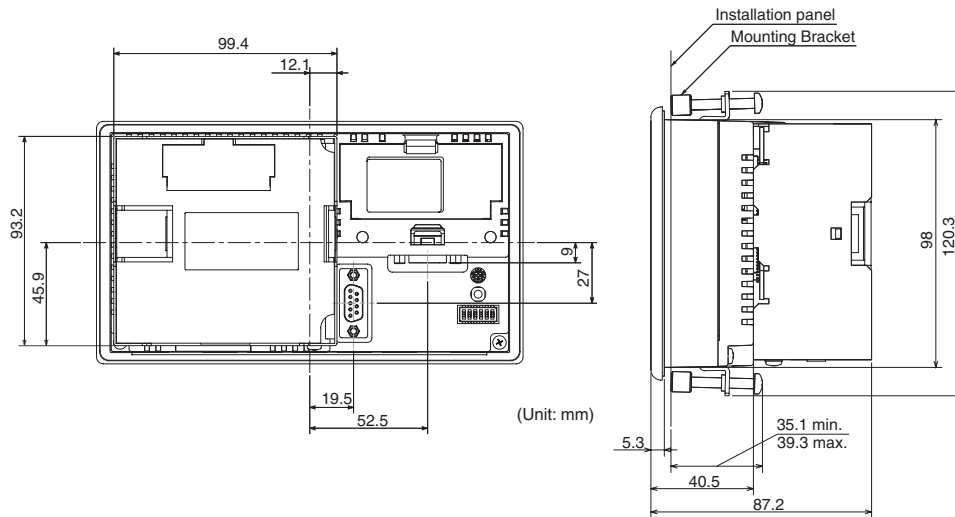

(Unit: mm)

# Appendix C

## Transporting and Storing PTs

- Use the special packing box provided with the PT when shipping the PT.
- When storing the PT, store it under the following conditions:
  - Ambient storage temperature:  $-20$  to  $70^{\circ}\text{C}$
  - Ambient storage humidity: 35% to 85% ( $-20$  to  $40^{\circ}\text{C}$ )
    - 35% to 50% ( $40$  to  $50^{\circ}\text{C}$ )
    - 35% to 45% ( $50$  to  $70^{\circ}\text{C}$ )



# Appendix D

## Making the Cable

The procedure for making up the cable is described below.

Also refer to this procedure for making a connecting cable for use with RS-422A/485 type connections.

### Cable Preparation

The preparation of the cable differs according to whether or not the shielding wire is to be connected to the FG.

#### Cable with Shield Connected to FG

1. Cut the cable to the required length.
2. Remove the external vinyl insulation from the cable with a razor blade. Take care not to damage the shielding underneath.
3. Cut back the shielding wire with scissors.
4. Use wire strippers to strip the insulation from each wire.
5. Fold back the shielding wire.
6. Wrap aluminum foil tape around the folded-back shielding wire.

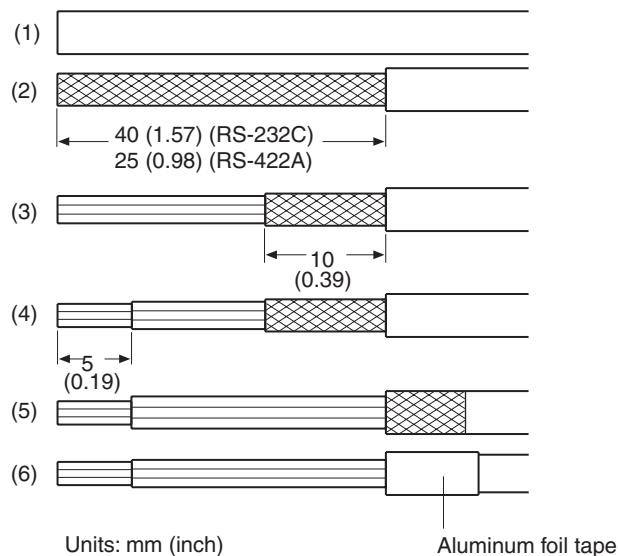

#### Cable with Shield Not Connected to FG

1. Cut the cable to the required length.
2. Remove the external vinyl insulation from the cable with a razor blade. Take care not to damage the shielding underneath.
3. Cut back the shielding wire with scissors.
4. Use wire strippers to strip the insulation from each wire.

- Wrap vinyl tape over the cut off end of the shielding wire.

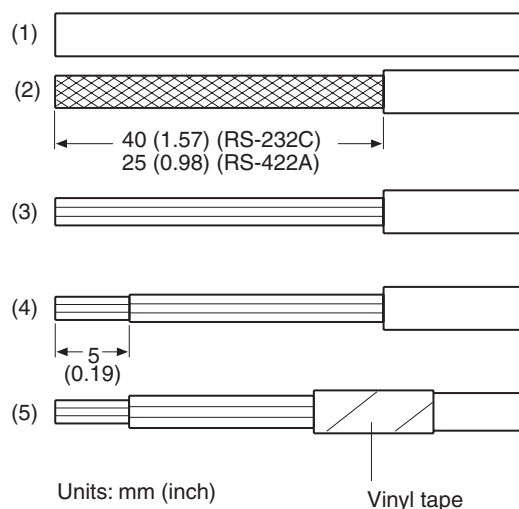

## Soldering

- Slide heat-shrink tube over each wire.
- Pre-solder each wire and connector terminal.
- Solder each wire to each connector terminal.

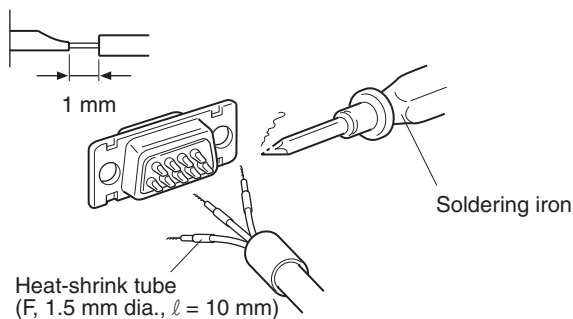

- Push the heat shrink tube over the soldered joint and heat the tube to shrink it in place.

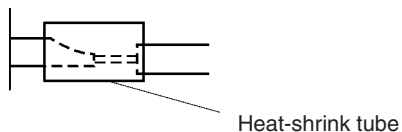

## Hood Assembly

Assemble the connector hood as shown below.

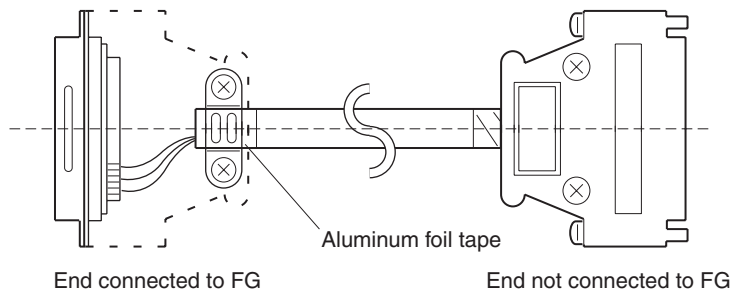

# Appendix E

## Making the Cable for Connecting a Personal Computer

Refer to the following when making a cable for connecting the NT Support Tool.

### Assembly of Connecting Cables

Wiring should be carried out in one of the following ways, depending on the type of RS-232C connector.

#### 25-pin Connector

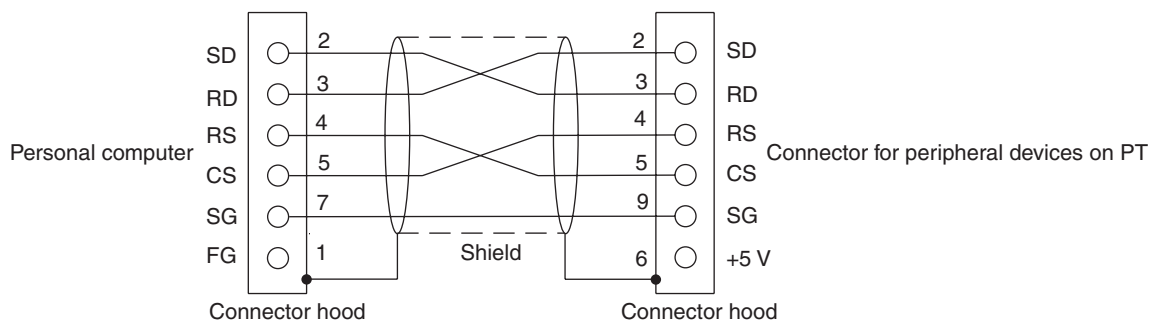

Use the following recommended products when making the connecting cable.

Name	Model	Remarks
Connector	XM2D-2501	25-pin, made by OMRON, for personal computer end
	XM2A-0901	9-pin, made by OMRON, for PT end
Connector hood	XM2S-2511	25-pin, made by OMRON, for personal computer end
	XM2S-0911	9-pin, made by OMRON, for PT end
Connector set	XM2S-0911-S003	9-pin, made by OMRON, for PT end Connector and Connector hood
Cable	AWG28×5P IFVV-SB	Multi-core shielded cable, made by Fujikura Ltd.
	CO-MA-VV-SB 5P×28AWG	Multi-core shielded cable, made by Hitachi Cable, Ltd.



### 9-pin Connector

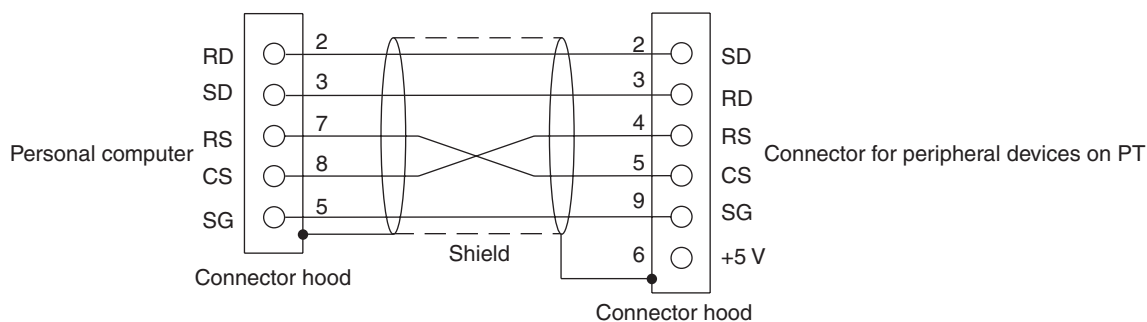

Use the following recommended products when making the connecting cable.

Name	Model	Remarks
Connector	XM2D-0901	9-pin, made by OMRON, for personal computer
	XM2A-0901	9-pin, made by OMRON, for PT
Connector hood (See note.)	XM2S-0911	9-pin, mm pitch screw, made by OMRON
	XM2S-0913	9-pin, inch pitch screw, made by OMRON
Connector set	XM2S-0911-S003	9-pin, made by OMRON, for PT end Connector and Connector hood
Cable	AWG28×5P IFVV-SB	Multi-core shielded cable, made by Fujikura Ltd.
	CO-MA-VV-SB 5P×28AWG	Multi-core shielded cable, made by Hitachi Cable, Ltd.

**Note** One XM2S-0911 (for PT) and either one XM2S-0911 or -0913 (for your personal computer) are needed.

# Appendix F

## Model List

### PTs

Model	Specification
NT20-ST121-E	Host link/NT link/C200H Japanese/English language support (Ivory)
NT20-ST121B-E	Host link/NT link/C200H Japanese/English language support (Black)
NT20-ST128	RS232C Japanese/English language support (Ivory)
NT20-ST128B	RS232C Japanese/English language support (Black)

### Host Link Units

Model	Specification	Applicable PLC
C120-LK201-V1	<ul style="list-style-type: none"> <li>Features a connector for RS-232C connections</li> <li>Type mounted to a CPU</li> </ul>	C-series C120 C200H C500(F) C1000H C2000(H)
C200H-LK201(-V1)	<ul style="list-style-type: none"> <li>Features a connector for RS-232C connections</li> <li>Type mounted to C200H base</li> </ul>	C-series C200H(S)/HE/HG/HX
C500-LK201-V1	Features a connector for RS-232C/RS-422A connections (switchable type).	C-series C500(F) C1000H C2000(H)
C500-LK203	Type mounted to C500 base	
CV500-LK201	<ul style="list-style-type: none"> <li>Features a connector for RS-232C connections and a connector for RS-232C/RS422A connections (switchable type).</li> <li>Type mounted to base for CVM1/CV use.</li> </ul>	CVM1/CV-series CV500 CV1000 CV2000 CVM1

### Communications Units

Model	Specification	Applicable PLC
CS1W-SCU21-V1	RS-232C (2 ports) Rack-mounting Unit	CS-series CS1G/H, CS1G/H-H
CS1W-SCU31-V1	RS-422A/485 (2 ports) Rack-mounting Unit	
CJ1W-SCU21-V1	RS-232C (2 ports)	CJ-series CJ1G, CJ1G/H-H
CJ1W-SCU31-V1	RS-422A/485 (2 ports)	
CJ1W-SCU41-V1	Features an RS-422A/485 (port 1) and an RS-232C port (port 2)	

### CPU Units (for Connection Via a Host Link)

Model	Specification	PLC Type
C20H/C28H/C40H/C60H	Features a 9-pin connector for RS-232C connections	C-series C20H C28H C40H C60H
CPM1-10CDR-□ CPM1-20CDR-□ CPM1-30CDR-□ CPM1A-10CDR□-□ CPM1A-30CDR□-□ CPM1A-40CDR□-□	Connect an RS-232C adapter to the peripheral port.	C-series CPM1 CPM1A
CPM2A-30CD□□-□ CPM2A-40CD□□-□ CPM2A-60CD□□-□	Connect an RS-232C adapter to the peripheral port.	C-series CPM2A
CPM2C-10□□□□□□-□ (See note 1.) CPM2C-20□□□□□□-□ (See note 1.)	Connect an RS-232C adapter to the peripheral port.	C-series CPM2C
CQM1-CPU21-E CQM1-CPU41-E CQM1-CPU42-E CQM1-CPU43-E CQM1-CPU44-E	Features a 9-pin connector for RS-232C connections.	C-series CQM1
CQM1H-CPU11 (See note 2.)	Connect an RS-232C adapter to the peripheral port.	C-series CQM1H
CQM1H-CPU21 CQM1H-CPU51 CQM1H-CPU61	Features a 9-pin connector for RS-232C connections.	
C200HS-CPU21-E C200HS-CPU23-E C200HS-CPU31-E C200HS-CPU33-E	Features a connector for RS-232C connections (selectable/9-pin).	C200HS
C200HE-CPU32-(Z)E (*) C200HE-CPU42-(Z)E	Features a connector for RS-232C connections (selectable/9-pin)	C-series C200HE
C200HG-CPU33-(Z)E (*) C200HG-CPU43-(Z)E C200HG-CPU53-(Z)E (*) C200HG-CPU63-(Z)E	Features a connector for RS-232C connections (selectable/9-pin).	C-series C200HG
C200HX-CPU34-(Z)E (*) C200HX-CPU44-(Z)E C200HX-CPU54-(Z)E (*) C200HX-CPU64-(Z)E C200HX-CPU65-(Z)E C200HX-CPU85-(Z)E	Features a connector for RS-232C connections (selectable/9-pin).	C-series C200HX
CV500-CPU01-EV1 CV1000-CPU01-EV1 CV2000-CPU01-EV1 CVM1-CPU01-EV1 CVM1-CPU11-EV1 CVM1-CPU21-EV1	Features a connector for RS-232C connections (selectable/9-pin).	CVM1/CV-series CV500 CV1000 CV2000 CVM1

<b>Model</b>	<b>Specification</b>	<b>PLC Type</b>
CS1G-CPU42-EV1 CS1G-CPU43-E1 CS1G-CPU44-EV CS1G-CPU45-EV	Features a connector for RS-232C connections.	CS-series CS1G
CS1H-CPU63-EV1 CS1H-CPU64-EV1 CS1H-CPU65-EV1 CS1H-CPU66-EV1 CS1H-CPU67-EV1	Features a connector for RS-232C connections.	CS-series CS1H
CS1G-CPU42H CS1G-CPU43H CS1G-CPU44H CS1G-CPU45H	Features a connector for RS-232C connections.	CS-series CS1G-H
CS1H-CPU63H CS1H-CPU64H CS1H-CPU65H CS1H-CPU66H CS1H-CPU67H	Features a connector for RS-232C connections.	CS-series CS1H-H
CJ1G-CPU44 CJ1G-CPU45	Features a connector for RS-232C connections.	CS-series CJ1G

**Note** For CPU units marked (\*), a communications board is required.

1. Use a CPM2C-CN111 or CS1W-CN114/118 Connecting Cable, CPM1-CIF01 RS-232C Adapter, or CPM1-CIF11 RS-422A Adapter to connect.
2. The CQM1H-CPU11 does not have a built-in RS-232C port, so connect to the PT at the peripheral port with a CS1W-CN118 Connecting Cable.

### CPU Units (for Connection Via an NT Link (1:1))

Model	Specification	PLC Type
CPM1-10CDR-□ CPM1-20CDR-□ CPM1-30CDR-□	Connect an RS-232C adapter to the peripheral port.	C-series CPM1
CQM1-CPU41-E CQM1-CPU42-E CQM1-CPU43-E CQM1-CPU44-E	Features a 9-pin connector for RS-232C connections.	C-series CQM1
CQM1H-CPU21-E (*) CQM1H-CPU51-E CQM1H-CPU61-E	Features a 9-pin connector for RS-232C connections.	C-series CPM1H
CPM1A-10CD□-□ CPM1A-20CD□-□ CPM1A-30CD□-□ CPM1A-40CD□-□	Connect an RS-232C adapter to the peripheral port.	C-series CPM1A
CPM2A-30CD□□-□ CPM2A-40CD□□-□ CPM2A-60CD□□-□	Features a 9-pin connector for RS-232C connections.	C-series CPM2A
CPM2C-10□□□□□□-□ (See note 1.) CPM2C-20□□□□□□-□ (See note 1.)	Connect an RS-232C adapter to the peripheral port.	C-series CPM2C
C200HS-CPU21-E C200HS-CPU23-E C200HS-CPU31-E C200HS-CPU33-E	Features a 9-pin connector for RS-232C connections.	C200HS
C200HE-CPU32-E(*) C200HE-CPU42-E	Features a connector for RS-232C connections (selectable/9-pin).	C-series C200HE
C200HG-CPU33-E(*) C200HG-CPU43-E C200HG-CPU53-E(*) C200HG-CPU63-E	Features a connector for RS-232C connections (selectable/9-pin).	C-series C200HG
C200HX-CPU34-E(*) C200HX-CPU44-E C200HX-CPU54-E(*) C200HX-CPU64-E	Features a connector for RS-232C connections (selectable/9-pin).	C-series C200HX
CV500-CPU01-V1-EV1 CV1000-CPU01-V1-EV1 CV2000-CPU01-V1-EV1 CV2000 CPU01 V1 EV1 CVM1-CPU01-V1-EV□ CVM1-CPU11-V1-EV□ CVM1-CPU21-EV□	Features a 9-pin connector for RS-232C connections	CV500 CV1000 CV2000 CVM1-series

**Note** For CPU units marked (\*), a communications board is required.

1. Use a CPM2C-CN111 or CS1W-CN114/118 Connecting Cable, CPM1-CIF01 RS-232C Adapter, or CPM1-CIF11 RS-422A Adapter to connect.

### CPU Units (for Connection Via an NT Link (1:N))

Model	Specification	PLC Type
C200HE-CPU32-(Z)E(*) C200HE-CPU42-(Z)E	Features a connector for RS-232C connections (selectable/9-pin).	C-series C200HE-(Z)E
C200HG-CPU33-(Z)E(*) C200HG-CPU43-(Z)E C200HG-CPU53-(Z)E(*) C200HG-CPU63-(Z)E	Features a connector for RS-232C connections (selectable/9-pin).	C-series C200HG-(Z)E
C200HX-CPU34-(Z)E(*) C200HX-CPU44-(Z)E C200HX-CPU54-(Z)E(*) C200HX-CPU64-(Z)E C200HX-CPU65-(Z)E C200HX-CPU85-(Z)E	Features a connector for RS-232C connections (selectable/9-pin).	C-series C200HX-(Z)E
CQM1H-CPU51 (*) CQM1H-CPU61 (*)	Features a connector for RS-232C connections.	C-series CQM1H
CS1G-CPU42-EV1 CS1G-CPU43-EV1 CS1G-CPU44-EV1 CS1G-CPU45-EV1	Features a connector for RS-232C connections.	CS-series CS1G
CS1H-CPU63-EV1 CS1H-CPU64-EV1 CS1H-CPU65-EV1 CS1H-CPU66-EV1	Features a connector for RS-232C connections.	CS-series CS1H
CS1G-CPU42H CS1G-CPU43H CS1G-CPU44H CS1G-CPU45H	Features a connector for RS-232C connections.	CS-series CS1G-H
CS1H-CPU63H CS1H-CPU64H CS1H-CPU65H CS1H-CPU66H CS1H-CPU67H	Features a connector for RS-232C connections.	CS-series CS1H-H
CJ1G-CPU44 CJ1G-CPU45	Features a connector for RS-232C connections.	CJ-series CJ1G

**Note** For CPU units marked (\*), a communications board is required.

**CPU Units (for Connection Via an High-speed NT Link (1:N))**

Model	Specification	PLC Type
CS1G-CPU42-EV1 CS1G-CPU43-EV1 CS1G-CPU44-EV1 CS1G-CPU45-EV1	Features a connector for RS-232C connections.	CS-series CS1G
CS1H-CPU63-EV1 CS1H-CPU64-EV1 CS1H-CPU65-EV1 CS1H-CPU66-EV1	Features a connector for RS-232C connections.	CS-series CS1H
CS1G-CPU42H CS1G-CPU43H CS1G-CPU44H CS1G-CPU45H	Features a connector for RS-232C connections.	CS-series CS1G-H
CS1H-CPU63H CS1H-CPU64H CS1H-CPU65H CS1H-CPU66H CS1H-CPU67H	Features a connector for RS-232C connections.	CS-series CS1H-H
CJ1G-CPU44 CJ1G-CPU45	Features a connector for RS-232C connections.	CJ-series CJ1G

**Note** The direct high-speed 1:N NT Link connection is not supported by CS1-series CPU Units without the -EV1 suffix.

### CPU Units (Connected by C200H Direct Communications)

Model	Product Name
C20H-C□DR-DE-V1 C20H-C□DT-DE-V1	C20H
C28H-C□DR-DE-V1 C28H-C□DT-DE-V1	C28H
C40H-C□DR-DE-V1 C40H-C□DT-DE-V1	C40H
C60H-C□DR-DE-V1 C60H-C□DT-DE-V1	C60H
C200H-CPU01-E C200H-CPU03-E C200H-CPU11-E C200H-CPU21-E C200H-CPU23-E C200H-CPU31-E	C200H
C200HS-CPU01-E C200HS-CPU03-E C200HS-CPU11-E C200HS-CPU21-E C200HS-CPU23-E C200HS-CPU31-E	C200HS
C200HE-CPU11-E C200HE-CPU32-E C200HE-CPU42-E	C200HE
C200HG-CPU33-E C200HG-CPU43-E C200HG-CPU53-E C200HG-CPU63-E	C200HG
C200HX-CPU34-E C200HX-CPU44-E C200HX-CPU54-E C200HX-CPU64-E	C200HX

### RS-232C/RS-422A Link Adapter

Model	Specification
NT-AL001	RS-232C: 9-pin connector RS-422A: 8-pin terminal block

### RS-422A Converter

Model	Specification
CJ1W-CIF11	Converts RS-232C to RS-422A or RS-485.

### RS-232C Adapter

Model	Specification
CPM1-CIF01	Connect the RS-232C port of the NT20 and the peripheral port of the CPM1.



## Related Products

Name	Model	Remarks
Support Tool	NT-ZJCAT1-EV4	For IBM PC/AT compatible, media: CD-ROM
Options	NT20S-KBA04	Reflection-suppressing protective sheet for NT20
	NT20S-KBA01	Chemical-resistant cover to NT20
	NT-MF261	Memory Unit for NT20

## Parts Used for Connection

### Cables with Connectors

Model	Cable Length	Applicable Units	Communications Method
XW2Z-200S	2 m	Host link units with 25-pin connectors	Host link
XW2Z-500S	5 m		
XW2Z-200T	2 m	Host link units and CPU units with 9-pin connectors	Host link, NT link (1 to 1)
XW2Z-500T	5 m		
C200H-CN311	30 cm	C200H, C200HS, C200HX/HG/HE	C200H direct communications
NT20M-CNP711 C200H-CN711	70 cm		
NT20M-CNP221 C200H-CN221	2 m		
NT20M-CNP521 C200H-CN521	5 m		
NT20M-CNP131 C200H-CN131	10 m		
C200H-CN312	30 cm	C□□H	
NT20M-CNP712 C200H-CN712	70 cm		
NT20M-CNP222 C200H-CN222	2 m		

### Connecting Cables (for Host Link, NT Link, and RS-232C)

Model	Specification
AWG28×5P IFVV-SB	Multiconductor shielded cable (FUJIKURA, Ltd.)
CO-MA-VV-SB 5P×28AWG	Multiconductor shielded cable (HITACHI Cable, Ltd.)

### Applicable Connectors (for Host Link, NT Link, and RS-232C)

Name	Model	Remarks
Connector	XM2A-2501	25-pin, manufactured by OMRON
	XM2A-0901	9-pin (Plug), manufactured by OMRON
	DB-25P	25-pin, manufactured by JAE
Connector cover	XM2S-2511	25-pin, manufactured by OMRON
	XM2S-0911	9-pin, manufactured by OMRON
	DB-C2-J9	25-pin, manufactured by JAE

# Appendix G

## Option List

### Interface Unit ... NT20-IF001

This is the Interface Unit used when connecting a Host Interface Unit for C200H direct communications.

The PTs and Interface Units that can be used with the NT20-IF001 are listed in the following table. Be sure to use an applicable PT and Interface Unit.

Mounting Attachment	Applicable PTs	Applicable Interface Units
NT20-IF001	NT20-series PTs	NT600M-LB122-V1

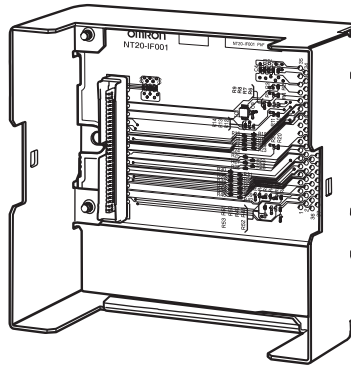

### C200H Interface Unit ... NT600M-LB122-V1

This is the Interface Unit for C200H communications.

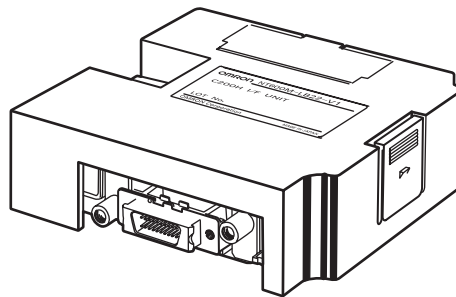

### Reflection-suppressing Protective Sheet ... NT20-KBA04

Stuck to the display to prevent it from being soiled. The entire sheet is colorless and transparent.

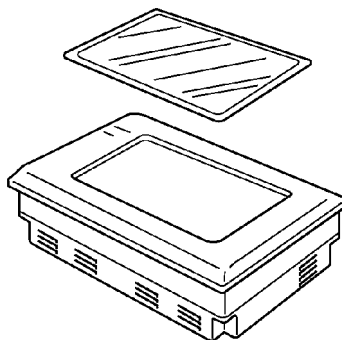

### Chemical-resistant Cover (NT20-KBA01)

Covers the front panel and protects it from chemical agents. The entire sheet is milky white and made of silicone rubber.

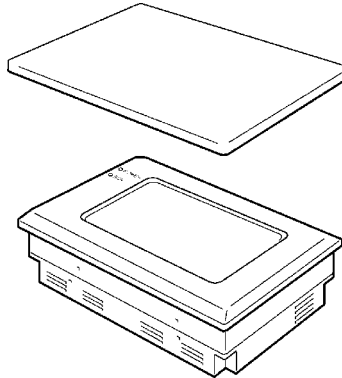

The protection the cover affords is summarized below.

Protects Against	Does Not Protect Against
Boric acid Sulfuric acid Nitric acid Ammonia gas Carbon dioxide Phenol Glycerin Ammonia water Calcium chloride Developing fluid ("hypo") Acetaldehyde Lard	Hexane Lubricating oils Benzene Butane Carbonic acid Chlorinated solvents Napthalene Soya oil Toluene

For information on protection against chemical agents not included in the table above, please ask OMRON. (If it is a chemical agent to which silicone rubber is recognized to be resistant, the cover can be used with confidence even if that chemical agent is not listed in the "Protects Against" column above.)

- Note**
- (1) This cover does not afford protection against all chemical agents.
  - (2) Since the cover is milky white, it reduces the clarity of the display a little.
  - (3) This cover is intended to be affixed to the display in order to provide protection against chemical agents. It will not provide protection against chemical agents that enter through the installation panel or through the gap between the cover and the display.

### Memory Unit (NT-MF261)

This is a special unit for reading/writing the screen data and the system programs in an NT20. Data is transmitted by DIP switch setting at the Memory Unit.

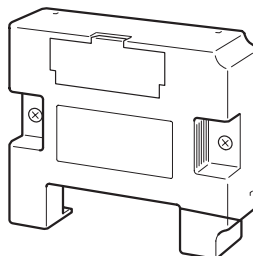

# Appendix H

## Special Characters

### English Character Codes

Pin 2 of SW2 must be ON to enable English language messages to use the following codes.

Example: Hex code is represented by 30, decimal code by 48, and character by 0.

30	0
48	

Code 20 and 32 in the table represents a space, as indicated by "SP."

Hex Digits 1st → 2nd ↓	2-		3-		4-		5-		6-		7-		8-		9-	
	-0	20	SP	30	0	40	@	50	P	60	`	70	p	80	Ç	90
	32		48		64		80		96		112		128		144	
-1	21	!	31	1	41	A	51	Q	61	a	71	q	81	ü	91	æ
	33		49		65		81		97		113		129		145	
-2	22	"	32	2	42	B	52	R	62	b	72	r	82	é	92	Æ
	34		50		66		82		98		114		130		146	
-3	23	#	33	3	43	C	53	S	63	c	73	s	83	â	93	ô
	35		51		67		83		99		115		131		147	
-4	24	\$	34	4	44	D	54	T	64	d	74	t	84	ä	94	ö
	36		52		68		84		100		116		132		148	
-5	25	%	35	5	45	E	55	U	65	e	75	u	85	à	95	ò
	37		53		69		85		101		117		133		149	
-6	26	&	36	6	46	F	56	V	66	f	76	v	86	â	96	û
	38		54		70		86		102		118		134		150	
-7	27	'	37	7	47	G	57	W	67	g	77	w	87	ç	97	ù
	39		55		71		87		103		119		135		151	
-8	28	(	38	8	48	H	58	X	68	h	78	x	88	ê	98	ÿ
	40		56		72		88		104		120		136		152	
-9	29	)	39	9	49	I	59	Y	69	i	79	y	89	ë	99	Ö
	41		57		73		89		105		121		137		153	
-A	2A	*	3A	:	4A	J	5A	Z	6A	j	7A	z	8A	è	9A	Ü
	42		58		74		90		106		122		138		154	
-B	2B	+	3B	;	4B	K	5B	[	6B	k	7B	{	8B	ï	9B	ç
	43		59		75		91		107		123		139		155	
-C	2C	,	3C	<	4C	L	5C	\	6C	l	7C		8C	î	9C	£
	44		60		76		92		108		124		140		156	
-D	2D	-	3D	=	4D	M	5D	]	6D	m	7D	}	8D	ì	9D	¥
	45		61		77		93		109		125		141		157	
-E	2E	.	3E	>	4E	N	5E	^	6E	n	7E	~	8E	Ä	9E	Pt
	46		62		78		94		110		126		142		158	
-F	2F	/	3F	?	4F	O	5F	_	6F	o	7F	△	8F	Å	9F	f
	47		63		79		95		111		127		143		159	

Hex Digits 1st → 2nd ↓	A-		B-		C-		D-		E-		F-	
	-0	A0 160	á	B0 176	⋮	C0 192	┌	D0 208	⊥	E0 224	α	F0 240
-1	A1 161	í	B1 177	■	C1 193	┐	D1 209	⌋	E1 225	β	F1 241	±
-2	A2 162	ó	B2 178	⋮	C2 194	└	D2 210	⌋	E2 226	Γ	F2 242	≥
-3	A3 163	ú	B3 179	┆	C3 195	└	D3 211	⌋	E3 227	π	F3 243	≤
-4	A4 164	ñ	B4 180	└	C4 196	—	D4 212	⌋	E4 228	Σ	F4 244	∫
-5	A5 165	Ñ	B5 181	≡	C5 197	+	D5 213	ƒ	E5 229	σ	F5 245	J
-6	A6 166	ä	B6 182	⌋	C6 198	≡	D6 214	⌋	E6 230	μ	F6 246	÷
-7	A7 167	ö	B7 183	⌋	C7 199	⌋	D7 215	⌋	E7 231	τ	F7 247	≈
-8	A8 168	ı	B8 184	└	C8 200	⌋	D8 216	≡	E8 232	Φ	F8 248	°
-9	A9 169	ı	B9 185	≡	C9 201	⌋	D9 217	└	E9 233	Θ	F9 249	.
-A	AA 170	ı	BA 186	⌋	CA 202	⌋	DA 218	└	EA 234	Ω	FA 250	•
-B	AB 171	½	BB 187	└	CB 203	⌋	DB 219	■	EB 235	δ	FB 251	√
-C	AC 172	¼	BC 188	└	CC 204	⌋	DC 220	■	EC 236	∞	FC 252	n
-D	AD 173	i	BD 189	└	CD 205	≡	DD 221	■	ED 237	φ	FD 253	2
-E	AE 174	«	BE 190	└	CE 206	≡	DE 222	■	EE 238	ε	FE 254	■
-F	AF 175	»	BF 191	└	CF 207	⌋	DF 223	■	EF 239	∩	FF 255	(See note.)

**Note** Used as the prefix for mark data codes (2 bytes).

# Appendix I

## Function Restrictions Depending on the Support Tool

Screens can be created for Host link, NT link, or C200H direct communications by using the conventional Support Tool indicated below.

In addition, the NT series Support Tool (Ver.2.□) can be used with Ver.4 of the direct connection function.

However, when the above Support Tool is used, restrictions apply to some functions as shown in the table below.

The expressions used for the Support Tools In the table have the following meanings.

NT V2: NT Series Support Tool (Ver.2.□)

Support Tool	NT Model	Direct Connection	Communications Mode	Support Tool Mode (NT20S memory switch)	Restrictions
NT V2	NT20M	Ver. 4	Standard	NT20M	250 screens max., Thumbwheel numeral settings not possible, no upper/lower limits, hexadecimal input not possible, indirect specification not possible, touch switch input notification fixed as "momentary", data transmission in screen units not possible.
	NT20S	Ver. 4	Standard/High-speed	NT20S	
	NT20S	Ver. 5	Standard/High-speed	NT20S	No restriction

The NT20 cannot be used with combinations of Support Tools and settings other than those indicated above.

Reference: The RS-232C can be used in the same way with the NT series Support Tool (Ver.2.□). The necessary Support Tool and "Tool Mode" (NT20 memory switch) settings in this case are as follows:

NT Model: NT20S

Direct setting: No

Communications mode: Standard/High-speed

Tool Mode: NT20S



# Index

## Numerics

25-pin connector, 267

9-pin connector, 268

## A

allocatable bits and words, 166

automatic reset function, 98

## B

backlight, 205

backlight mode, 205

bar graphs, 147

before operating, 14

buzzer attribute, 205

## C

cable preparation, 265

changing displayed numerals or character strings, 182

changing displayed numerical values or character strings, 184

changing the status of allocated bits, 195

changing the system settings, 83

character string memory table

    direct specification, 177

    displaying and referencing, 177

    indirect specification, 177

    initialization setting, 178

    number of registration words, 178

    setting, 178

checking the PT setting, 122

Communications Board, 44, 57, 60, 65

communications methods, 8

communications port, 8

communications type, 8

comparison between NT20S, NT20M, and NT20, 6

compatibility with NT20M/NT20S, 4

CompoBus/S Master Control Units

    manual, 15

connecting directly between RS-232C ports, 69

connecting the NT Support Tool, 35

connection method, 8

continuous buzzer, 205

continuous buzzer sound, 108

controlling the display elements, 167

controlling the NT20 status, 168

CPUs, 57, 60, 65

## D

data transmission in screen units, 102

description of parts, 18

determining touch switch status, 196

dimensions, 261

DIP switch settings, 19, 124

display

    numeric values (numeral table), 7

    reverse and flashing display, 138, 145

display elements

    character-string memory table, 11

    lamps, 10

    numeral memory table, 11

    touch switches, 11

displaying the system menu, 86

displays

    bar graphs, 7

    characters (character-string memory table), 7

    characters (text), 7

    lamps, 7

    marks, 7

    numeric keys, 7

    touch switches, 7

## E

EC Directives, xx

EMI Standard, xxi

EMS Standard, xxi

enlarged display, 137, 145

error messages, 213, 249

## F

file units, 102

## G

graph frame, 147



## H

hardware faults, 212, 248  
host link method, 44  
Host Link Unit, 44  
Host Link Units  
  manual, 15

## I

I/O check, 115  
  buzzer, 119  
  communications with the Support Tool, 116  
  LCD, 118  
  LED, 120  
  screen memory, 121  
  touch switches, 115  
initialization by using the DIP switch, 90  
initialization by using the system menu, 88  
initializing memory, 88  
inspection and cleaning, 218, 253  
intermittent buzzer, 205  
intermittent buzzer sound, 108  
IP65 waterproof requirements, 4

## K

key press sound, 106

## L

lamps, 150  
language function, 110

## M

maintenance of the NT20, 216, 253  
marks, 137  
memory switches, 91  
memory table  
  character-string memory table, 144  
  copying, 186  
  numeral memory table, 145  
menu item  
  Maintenance Mode, 87  
  Quit, 87  
  Transmit Mode, 87

menu tree, 84  
model list, 269

## N

ng, 195  
notification of display elements, 170  
notification of NT20 status, 170  
notification of numbers to the PLC, 199  
notification operation  
  alternate, 193  
  momentary, 193  
  reset, 194  
  set, 194  
NT Link  
  1:1 NT Link, 56  
  1:N NT Link, 60  
  high-speed 1:N NT Link, 65  
NT Support Tool  
  connecting, 35  
  manual, 15  
NT20 status control, 199  
numeral memory table  
  direct specification, 179  
  displaying and referencing, 178  
  indirect specification, 179  
  initialization setting, 180  
  number of registration words, 180  
numeral setting, 156  
  numeric key type, 157  
  thumbwheel type, 158  
numeric keys, 158

## O

operating status, 209  
operation flow, 82  
operation panel, 22  
operation with the system menu, 86

## P

power supply connection, 23  
precautions, xvii  
  EC Directives, xx  
Programming Tools  
  manuals, 15  
PT operating status, 208

PT status, 208  
PT status control area, 12, 168, 203  
PT status notify area, 12, 170

## **R**

radiated emission, xxi

## **S**

screen

- child screen, 140
- classification, 140
- composition of the screen, 136
- continuous screen, 141
- normal screen, 140
- NT20 screen, 136
- overlapping screen, 140
- parent screen, 140
- screen display, 140
- screen management, 136
- special screen number, 136
- switching the continuous screens, 141

screen attributes

- backlight attribute, 143
- buzzer attribute, 142
- numeral setting attribute, 142

screen data, 102

screen display, 203

screen switch setting, 172

screen switch strobe, 174, 209

screen switch timing, 173

screen switching function, 154

screen switching strobe, 171, 173

screens

- creating, 134

selecting the host communications method, 93

selecting the host communications port, 94

selecting the host link communications speed, 95

selecting the menu items, 87

selecting the NT link (1

- N) communications speed, 96

selecting unit numbers, 97

Serial Communications Board, 44, 61, 65

Serial Communications Boards

- manuals, 15

Serial Communications Unit, 44

serial port A, 8

serial port B, 8

setting the buzzer, 107

smoothing, 137, 145

soldering, 266

specifications, 255

starting the NT20, 83

Support Tool

- connecting the NT Support Tool, 35

Support Tool mode setting, 111

switching the screen display, 172

switching to the RUN mode, 105

System Installer

- manual, 15

system key functions, 154

system menu, 84

system program

- erasing, 127

- transferring, 126

system transfer tool, 126

## **T**

touch switches, 152

transmitting the screen data, 103

## **U**

upgrade bar graphs, 189

upper/lower limit check, 157

using numeric keys, 160

using the thumbwheel type, 161



## Revision History

A manual revision code appears as a suffix to the catalog number on the front cover of the manual.

Cat. No. V091-E1-01

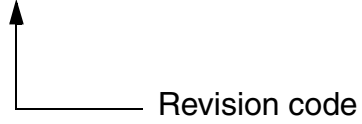

The following table outlines the changes made to the manual during each revision. Page numbers refer to the previous version.

Revision code	Date	Revised content
01	March 2007	Original production

---

*Revision History*

---

**OMRON Corporation**

**Control Devices Division H.Q.**

Shiokoji Horikawa, Shimogyo-ku,  
Kyoto, 600-8530 Japan  
Tel: (81)75-344-7109/Fax: (81)75-344-7149

**Regional Headquarters**

**OMRON EUROPE B.V.**

Wegalaan 67-69, NL-2132 JD Hoofddorp  
The Netherlands  
Tel: (31)2356-81-300/Fax: (31)2356-81-388

**OMRON ELECTRONICS LLC**

1 East Commerce Drive, Schaumburg, IL 60173  
U.S.A.  
Tel: (1)847-843-7900/Fax: (1)847-843-8568

**OMRON ASIA PACIFIC PTE. LTD.**

83 Clemenceau Avenue,  
#11-01, UE Square,  
Singapore 239920  
Tel: (65)6835-3011/Fax: (65)6835-2711

**OMRON (CHINA) CO., LTD.**

Room 2211, Bank of China Tower,  
200 Yin Cheng Zhong Road,  
PuDong New Area, Shanghai, 200120 China  
Tel: (86)21-5037-2222/Fax: (86)21-5037-2200

# OMRON

**Authorized Distributor:**