

# E5ER

**Digital Controller**

デジタル調節計

**Digitaler Regler**

**Contrôleur numérique**

**Regolatore digitale**

**Controlador digital**

EN	Connection Diagram	P1–P4
JPN	接続図	P5–P8
DE	Schaltplan	P9–P12
FR	Schéma de connexion	P13–P16
IT	Diagramma di connessione	P17–P20
ES	Esquema de conexiones	P21–P24

# Connections (E5ER)

**E5ER-Q4B**

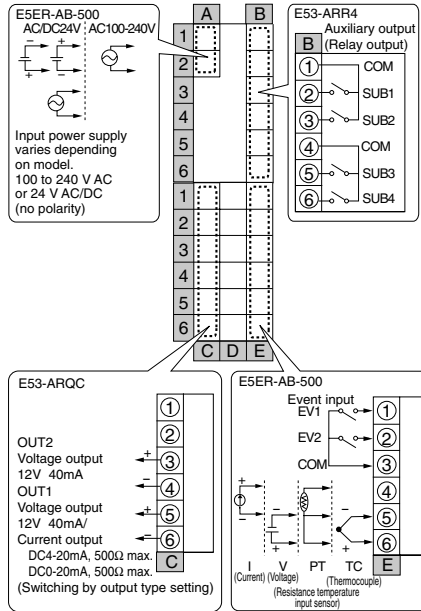

**E5ER-C4B**

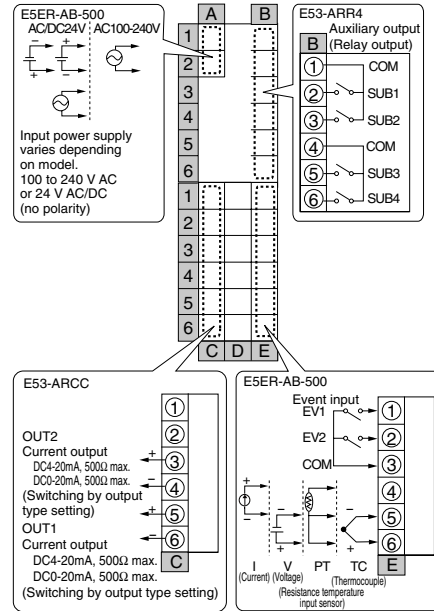

**E5ER-QT3DB-FLK**

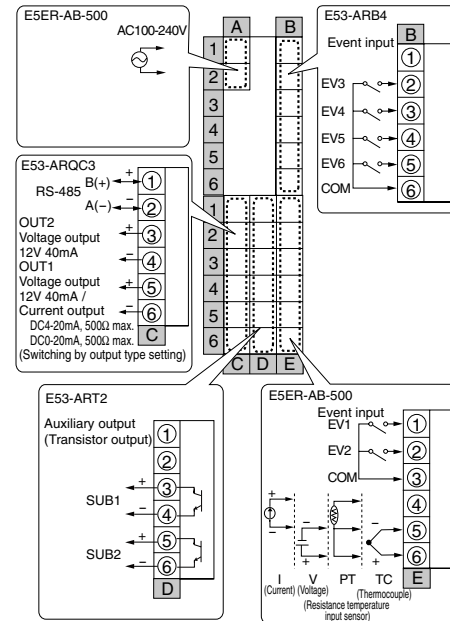

**E5ER-CT3DB-FLK**

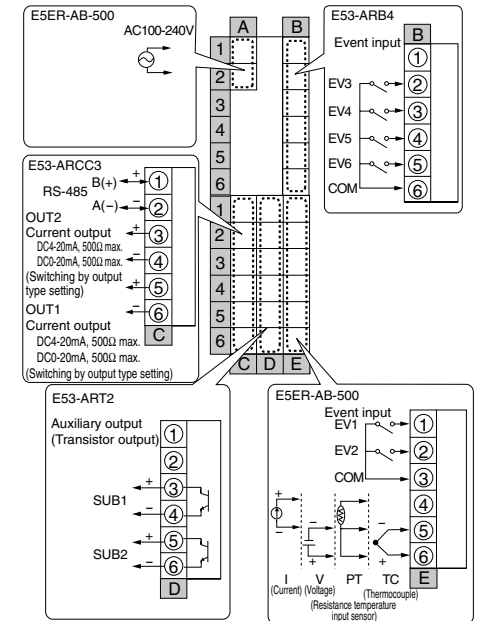

**E5ER-Q43B-FLK**

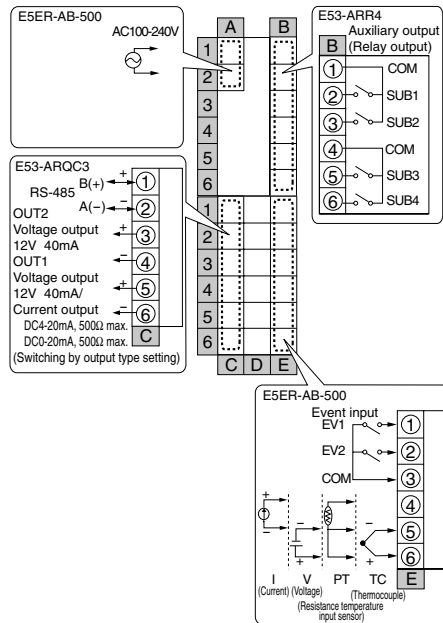

**E5ER-C43B-FLK**

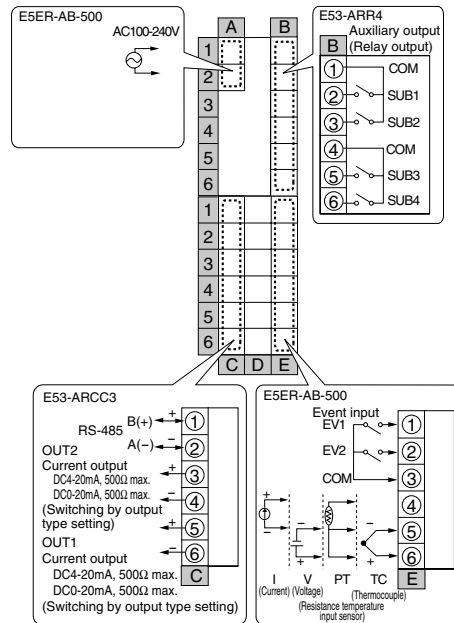

**E5ER-QC43B-FLK**

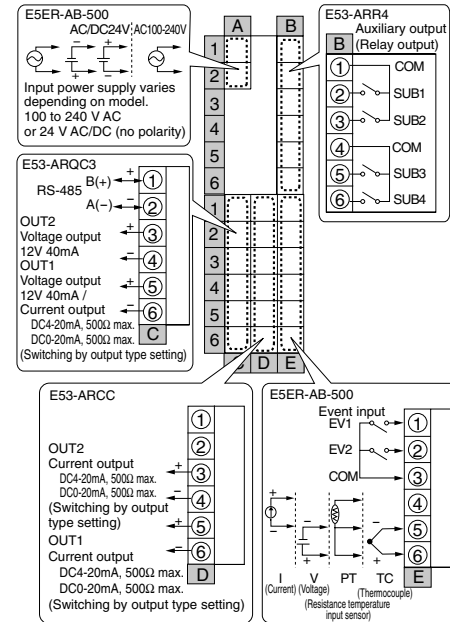

**E5ER-QT3DW-FLK (2-input type)**

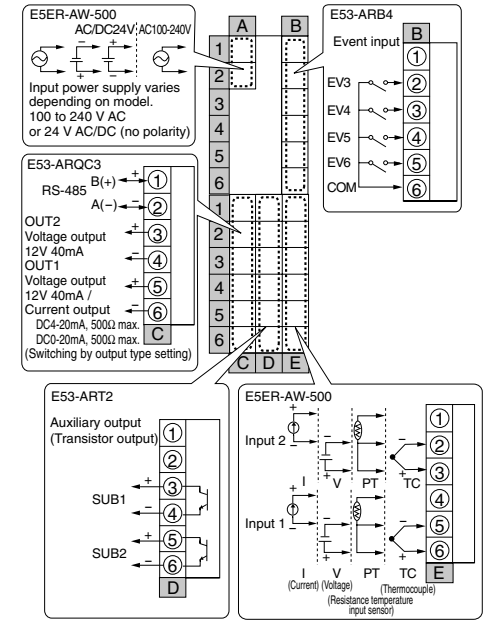

**E5ER-CT3DW-FLK (2-input type)**

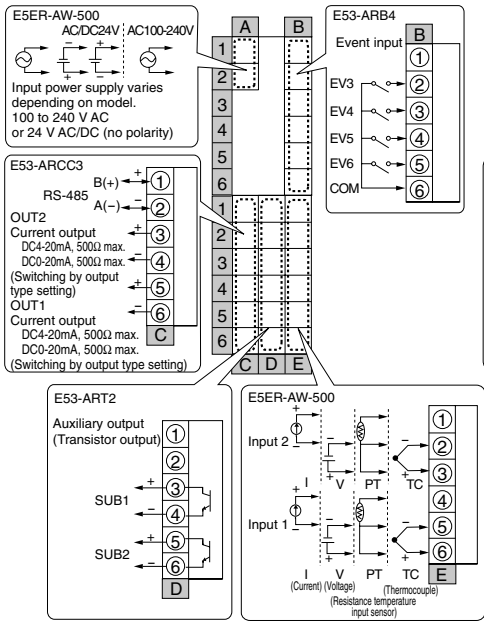

**E5ER-PRTF**

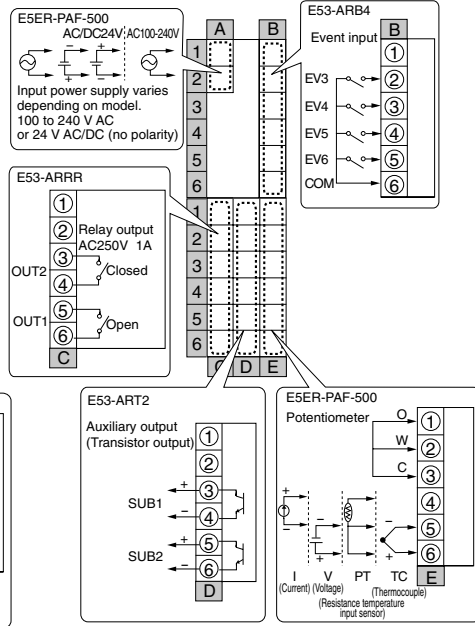

**E5ER-CTB-DRT**

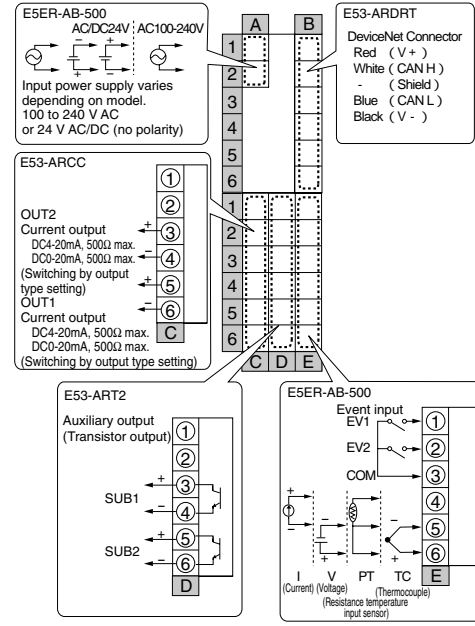

**E5ER-QTW-DRT (2-input type)**

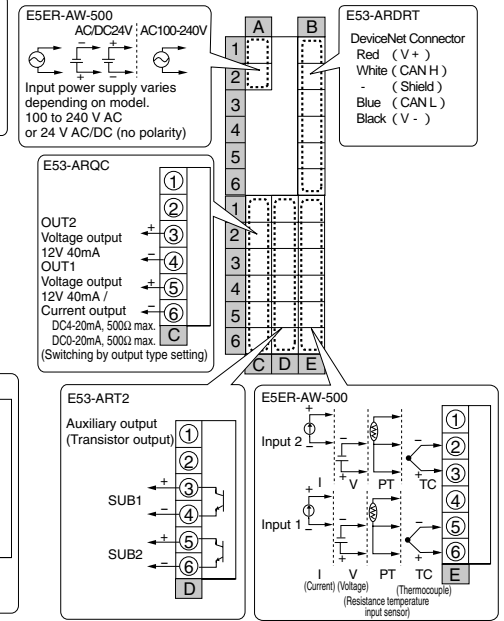

**E5ER-PRQ43F-FLK**

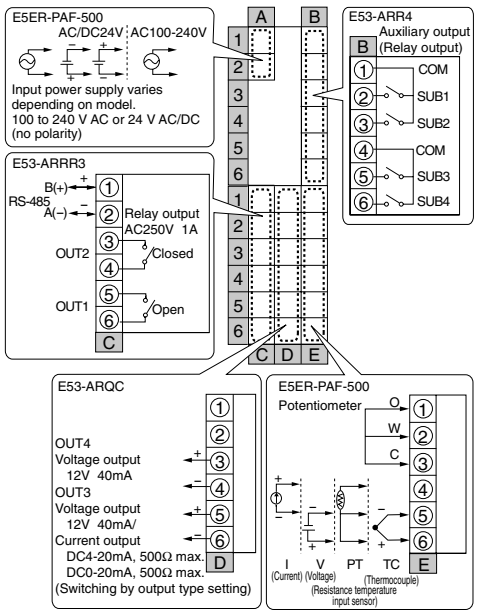

**E5ER-QTB-DRT**

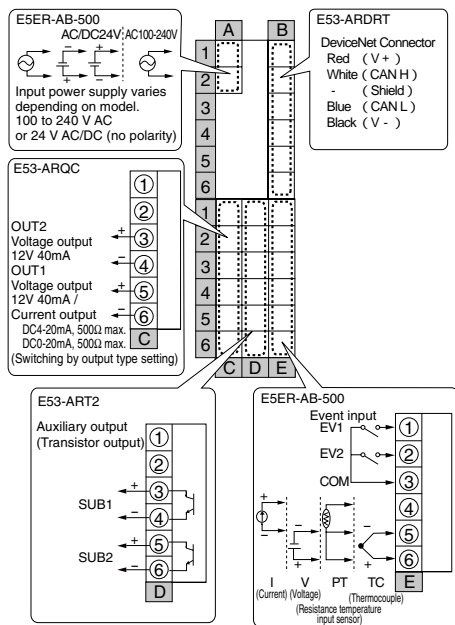

**E5ER-CTW-DRT (2-input type)**

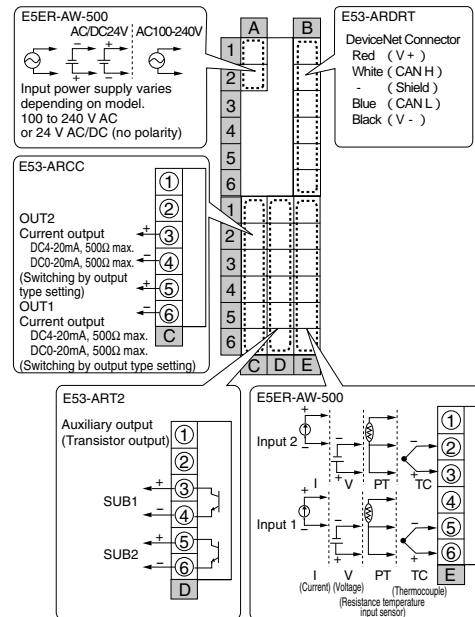

**E5ER-PRTF-DRT**

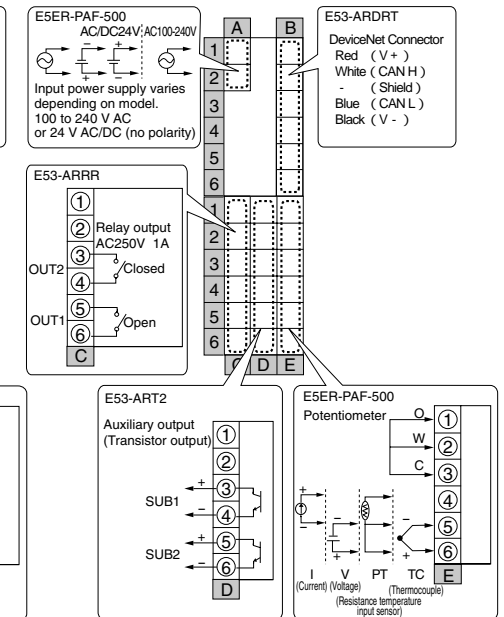

# 接続(E5ER)

E5ER-Q4B

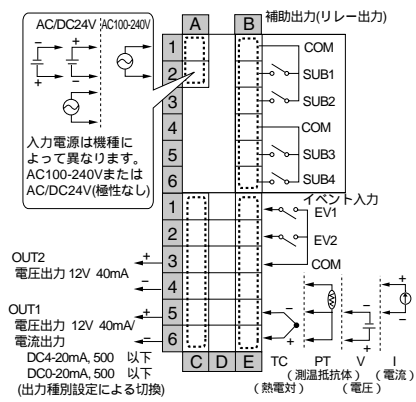

E5ER-C4B

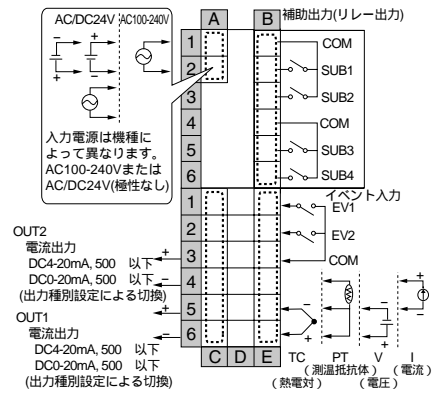

E5ER-QT3DB-FLK

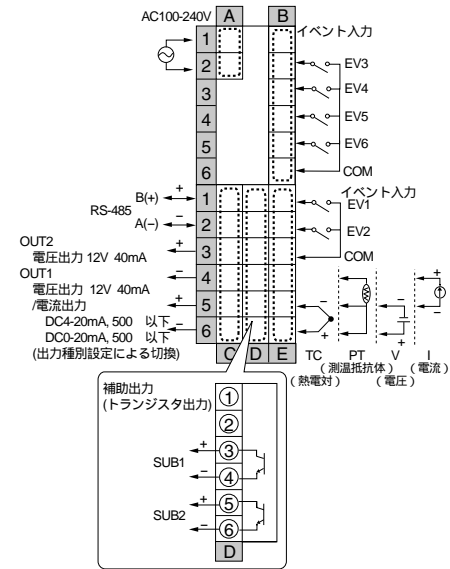

E5ER-CT3DB-FLK

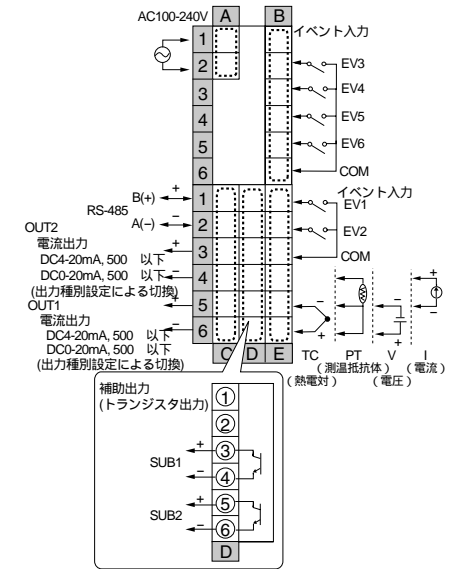

E5ER-Q43B-FLK

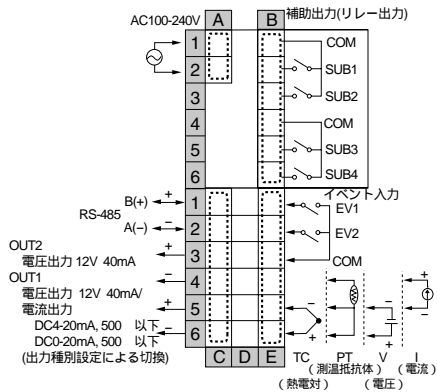

E5ER-C43B-FLK

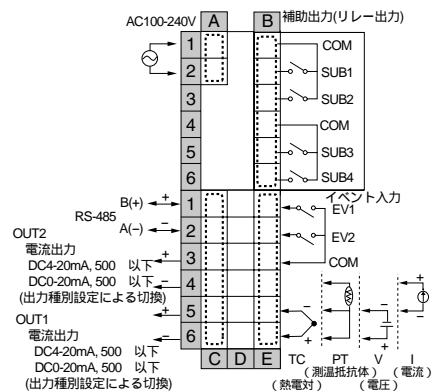

E5ER-QC43B-FLK

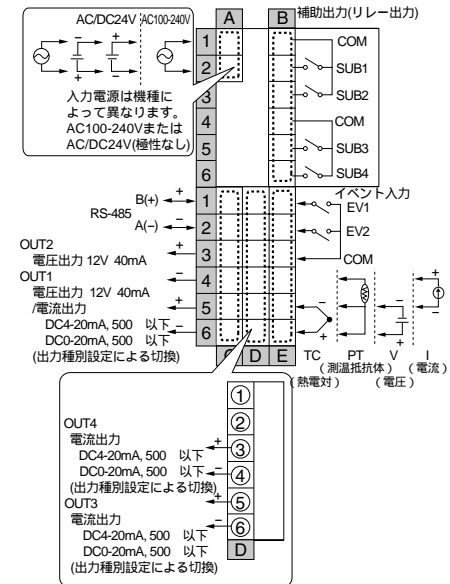

E5ER-QT3DW-FLK

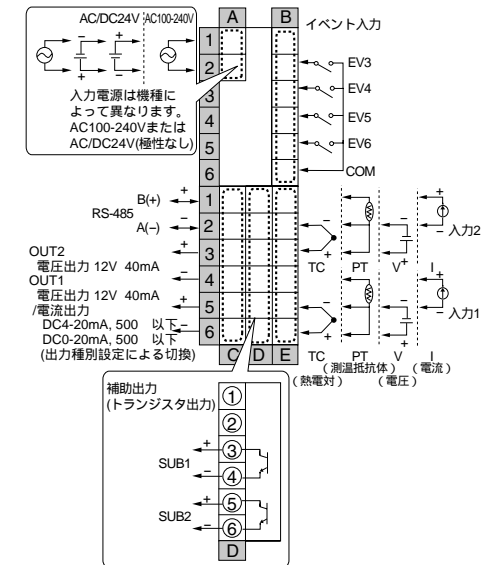

E5ER-CT3DW-FLK

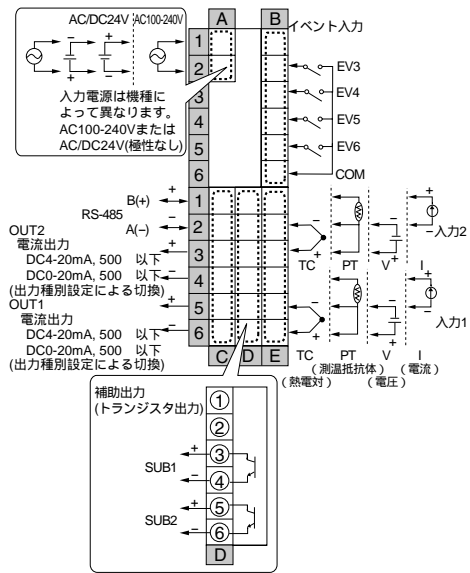

E5ER-PRTF

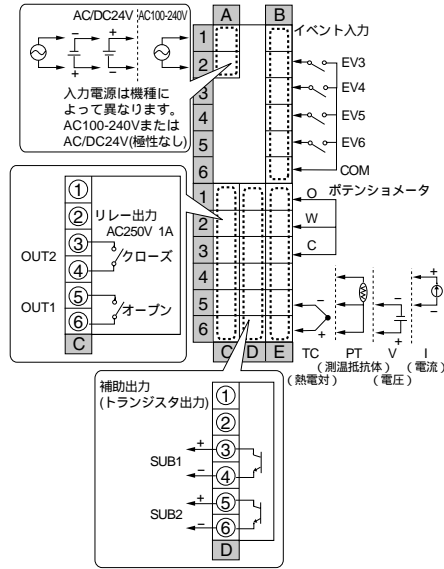

E5ER-CTB-DRT

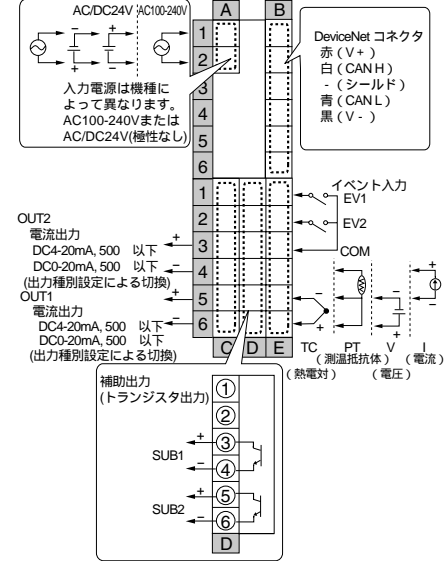

E5ER-QTW-DRT(2入力タイプ)

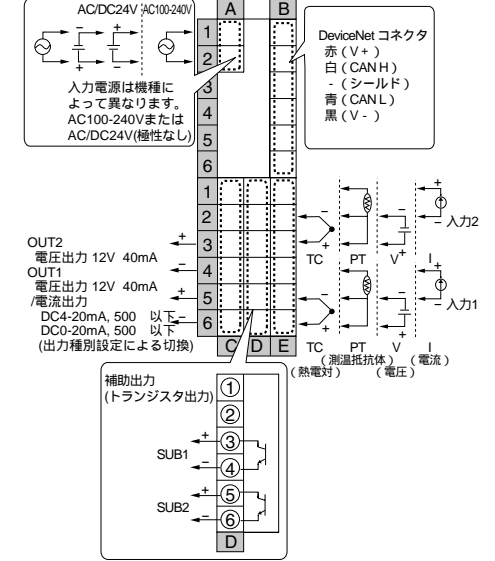

E5ER-PRQ43F-FLK

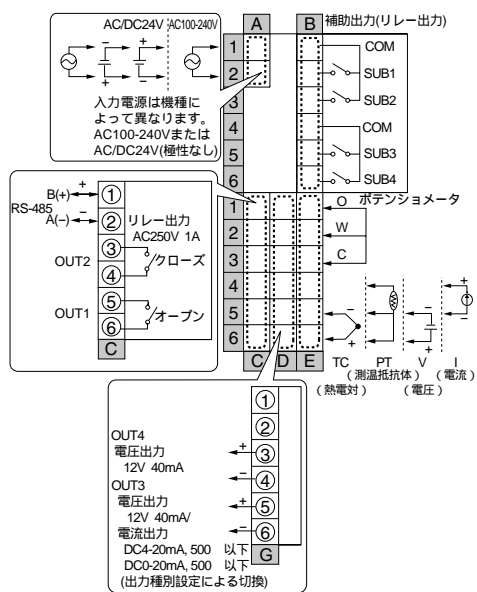

E5ER-QTB-DRT

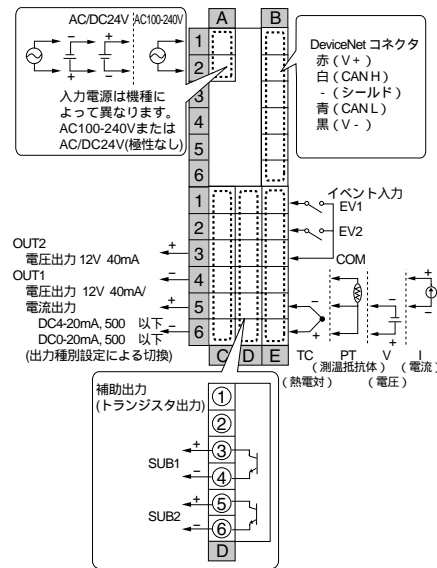

E5ER-CTW-DRT(2入力タイプ)

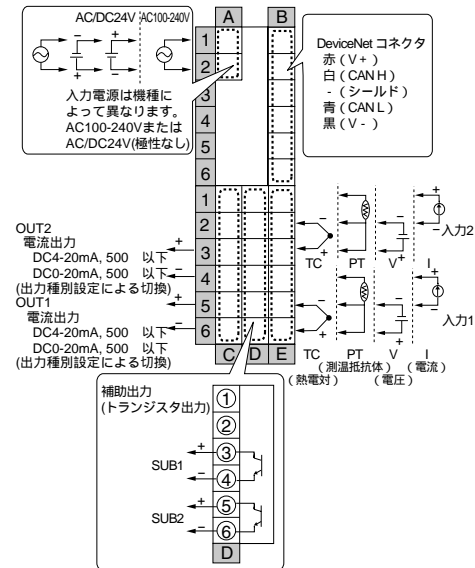

E5ER-PRTF-DRT

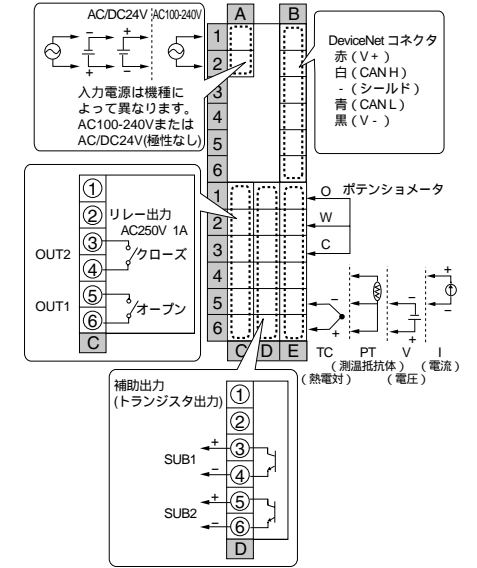

# Anschlüsse (E5ER)

E5ER-Q4B

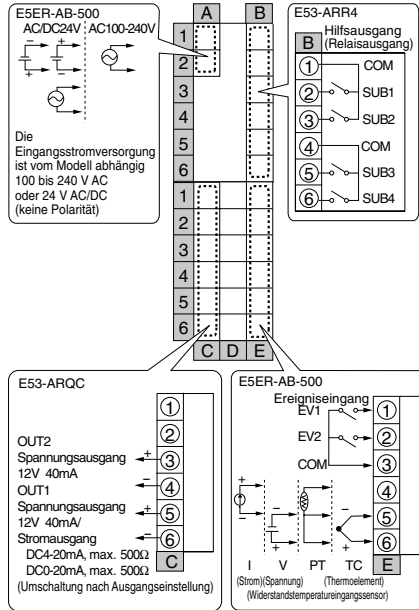

E5ER-C4B

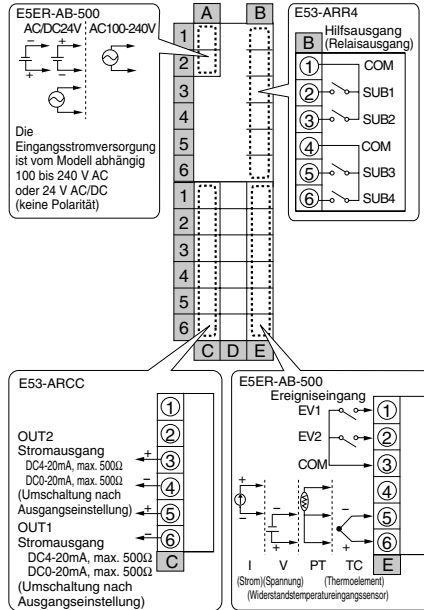

E5ER-QT3DB-FLK

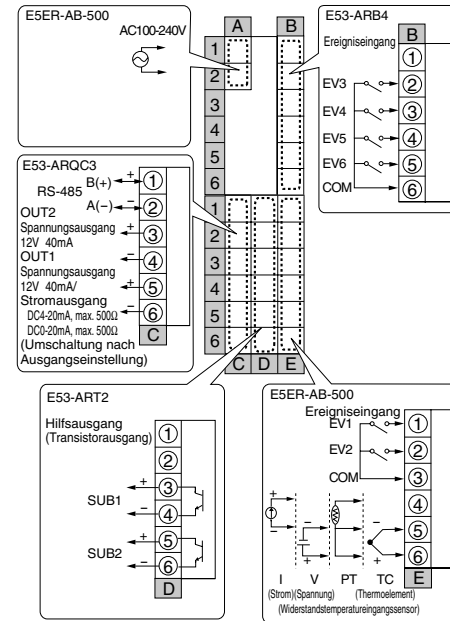

E5ER-CT3DB-FLK

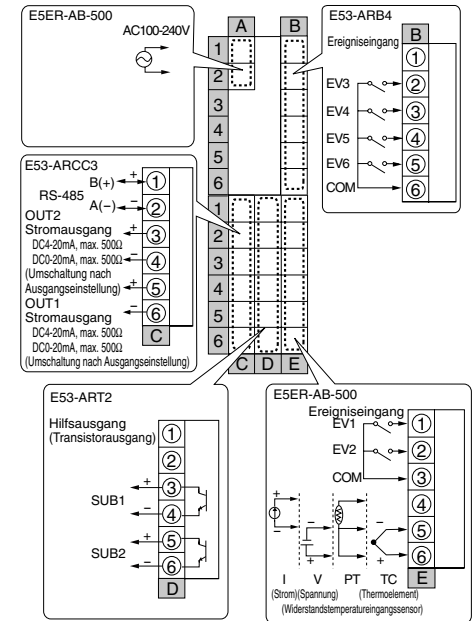

E5ER-Q43B-FLK

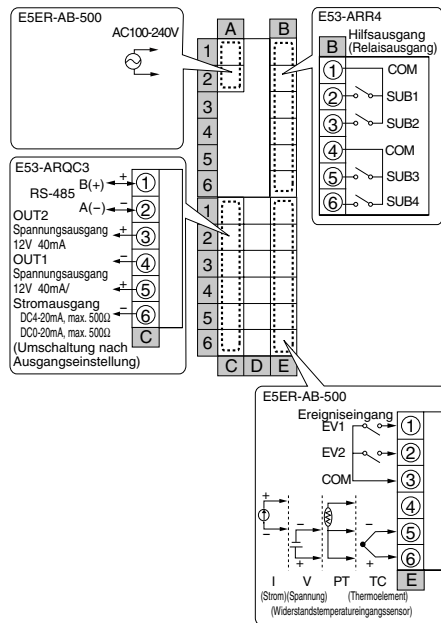

E5ER-C43B-FLK

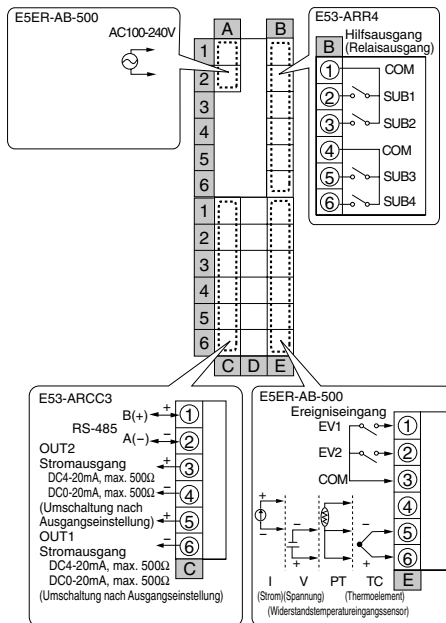

E5ER-QC43B-FLK

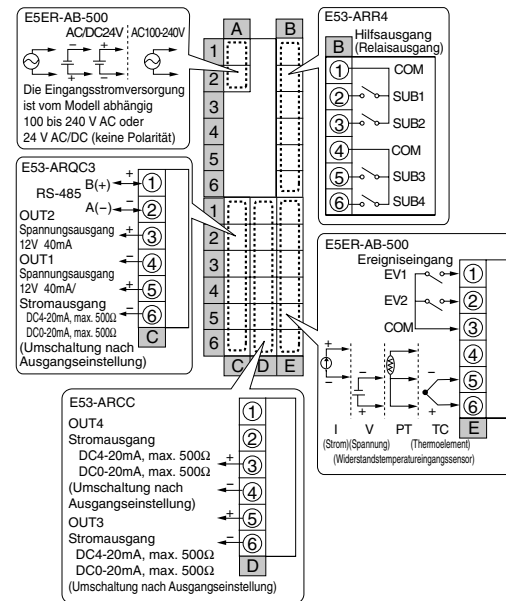

E5ER-QT3DW-FLK (Ausführung mit 2 Eingängen)

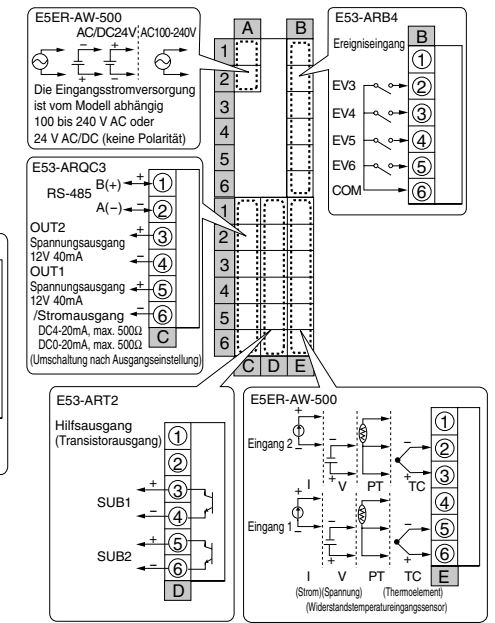

### E5ER-CT3DW-FLK (Ausführung mit 2 Eingängen)

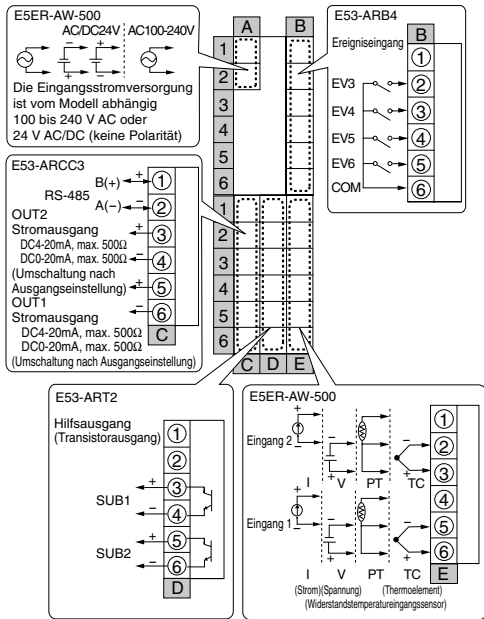

### E5ER-PRTF

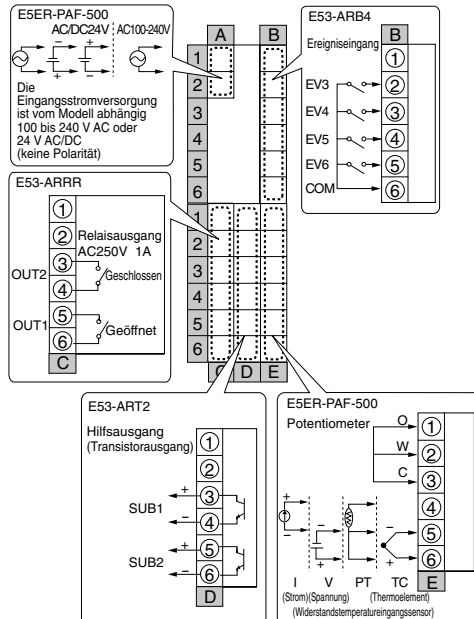

### E5ER-CTB-DRT

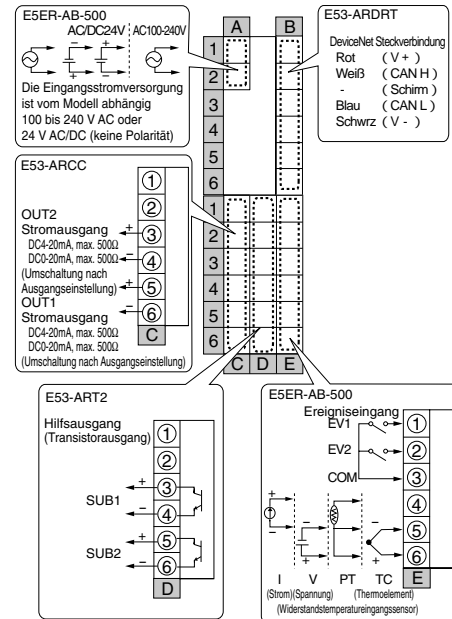

### E5ER-QTW-DRT (Ausführung mit 2 Eingängen)

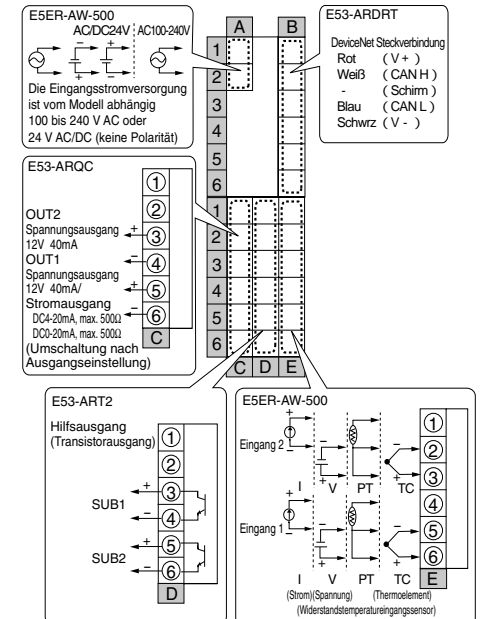

### E5ER-PRQ43F-FLK

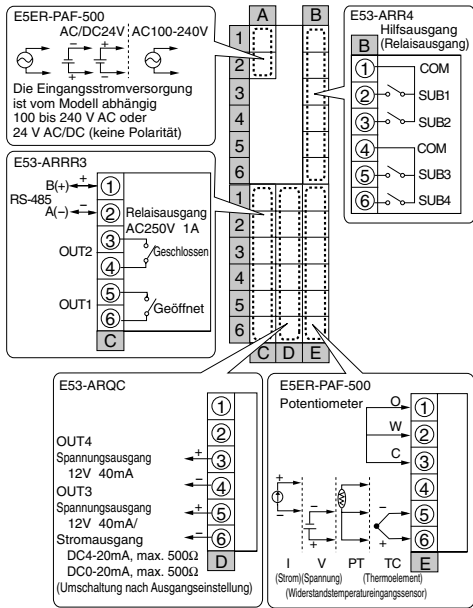

### E5ER-QTB-DRT

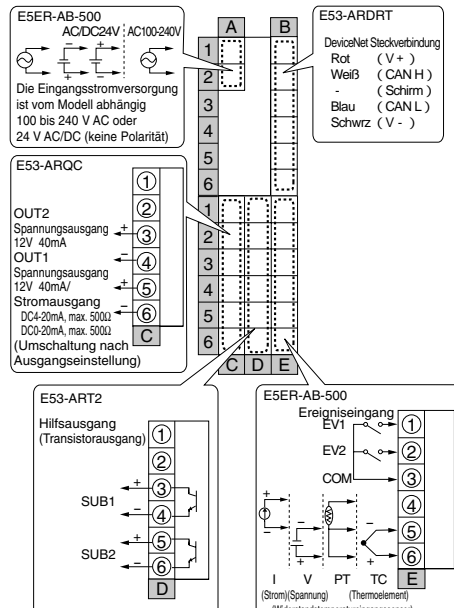

### E5ER-CTW-DRT (Ausführung mit 2 Eingängen)

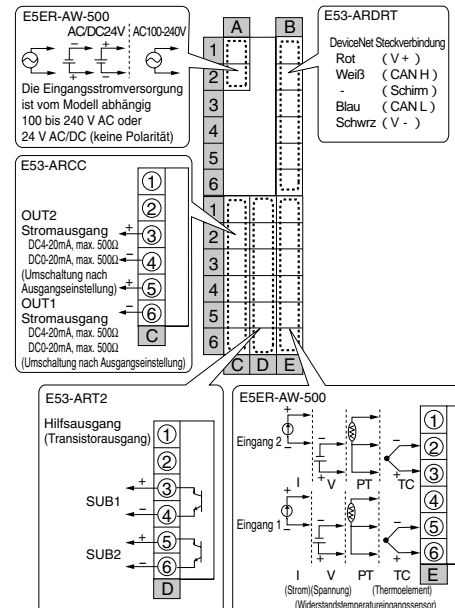

### E5ER-PRTF-DRT

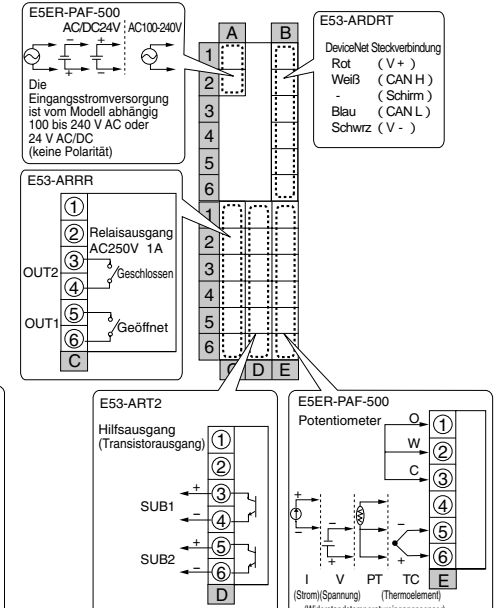



# Connexions (E5ER)

## E5ER-Q4B

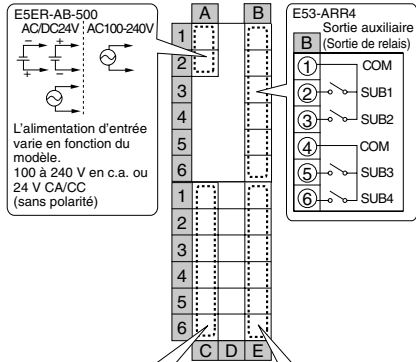

## E5ER-C4B

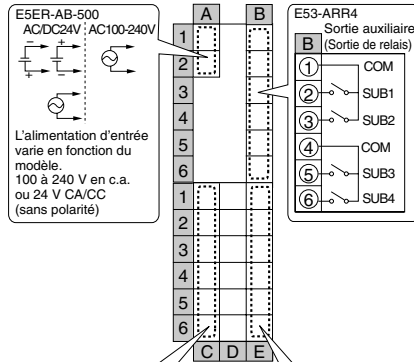

## E5ER-QT3DB-FLK

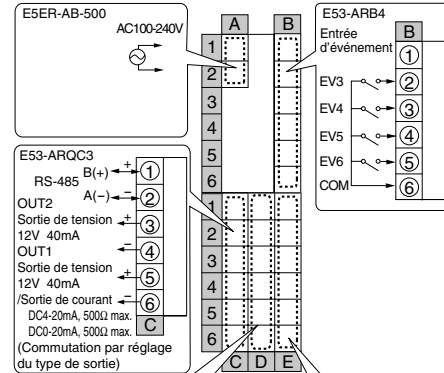

## E5ER-CT3DB-FLK

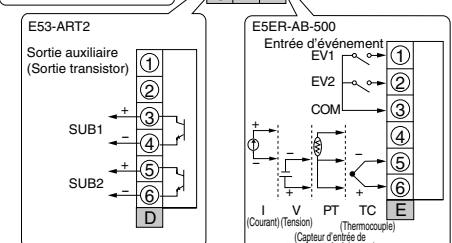
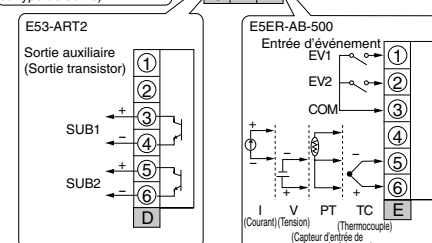
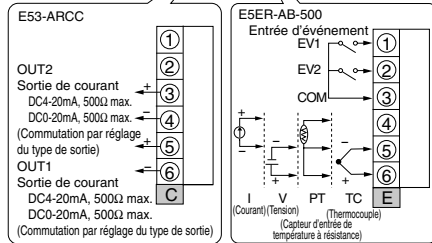
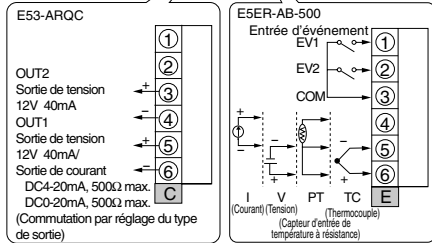
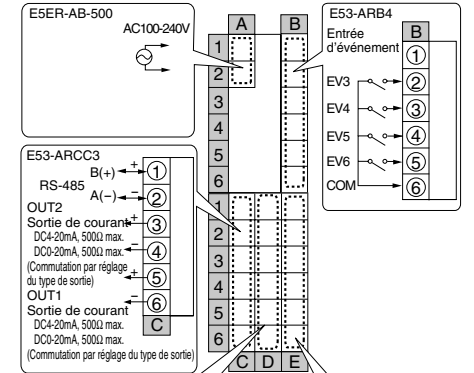

## E5ER-Q43B-FLK

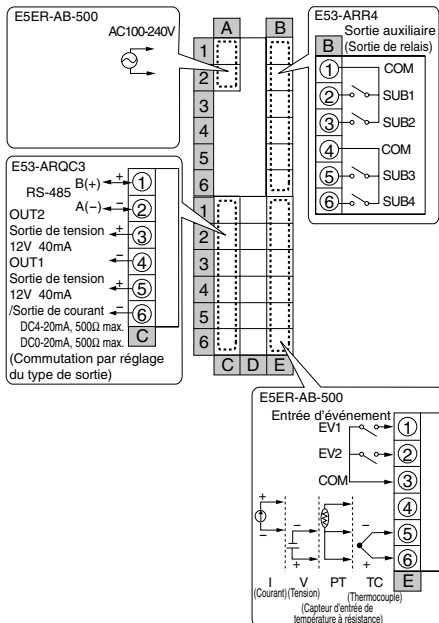

## E5ER-C43B-FLK

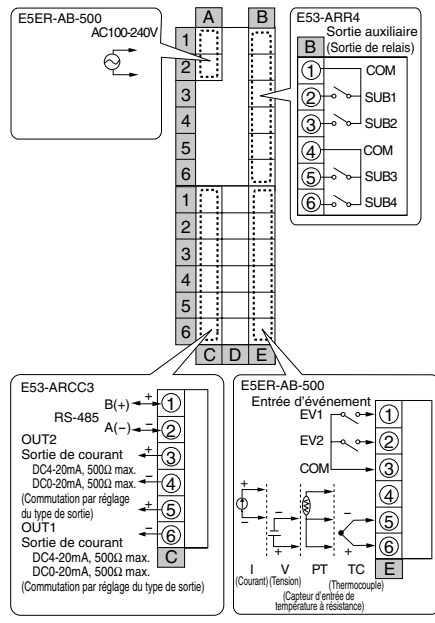

## E5ER-QC43B-FLK

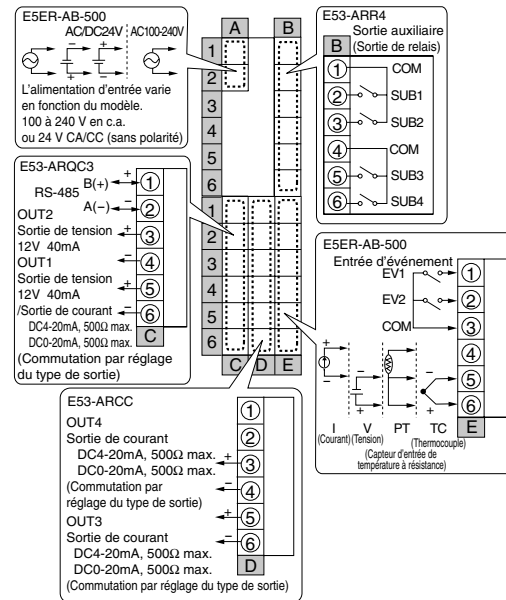

## E5ER-QT3DW-FLK (Type à 2 entrées)

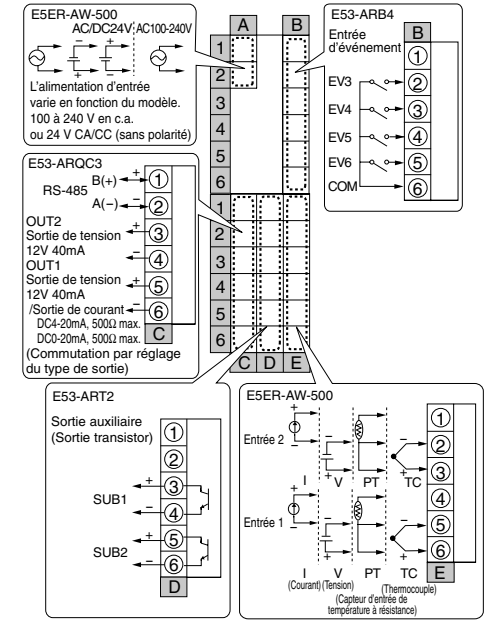



### E5ER-CT3DW-FLK (Type à 2 entrées)

### E5ER-PRTF

### E5ER-CTB-DRT

### E5ER-QTW-DRT (Type à 2 entrées)

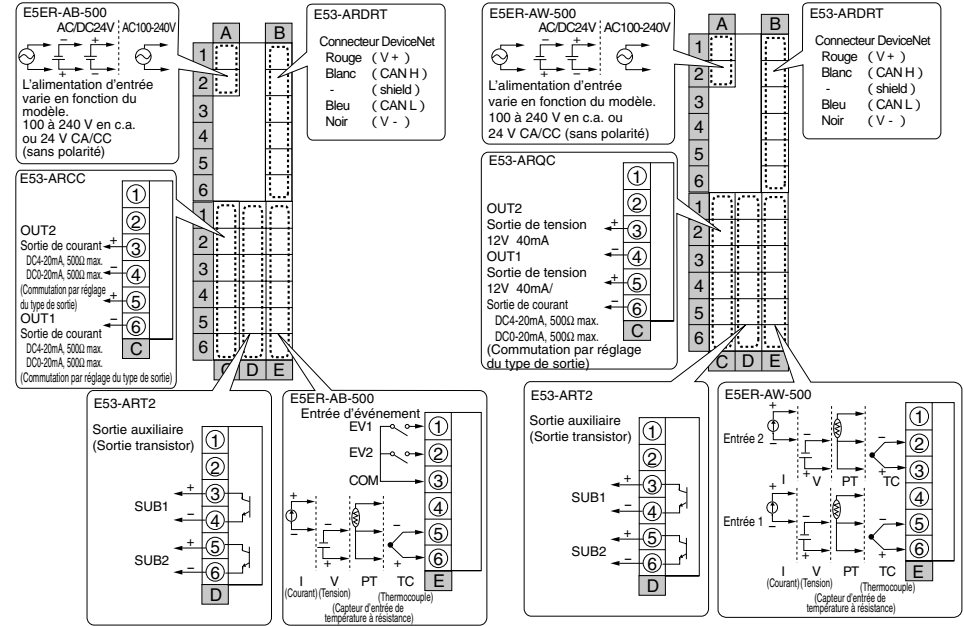
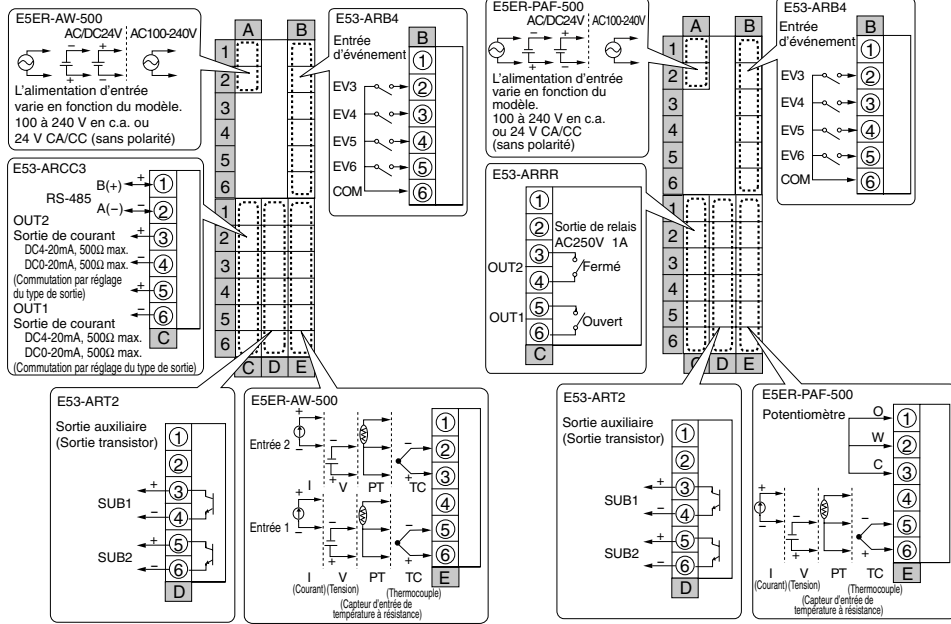

### E5ER-PRQ43F-FLK

### E5ER-QTB-DRT

### E5ER-CTW-DRT (Type à 2 entrées)

### E5ER-PRTF-DRT

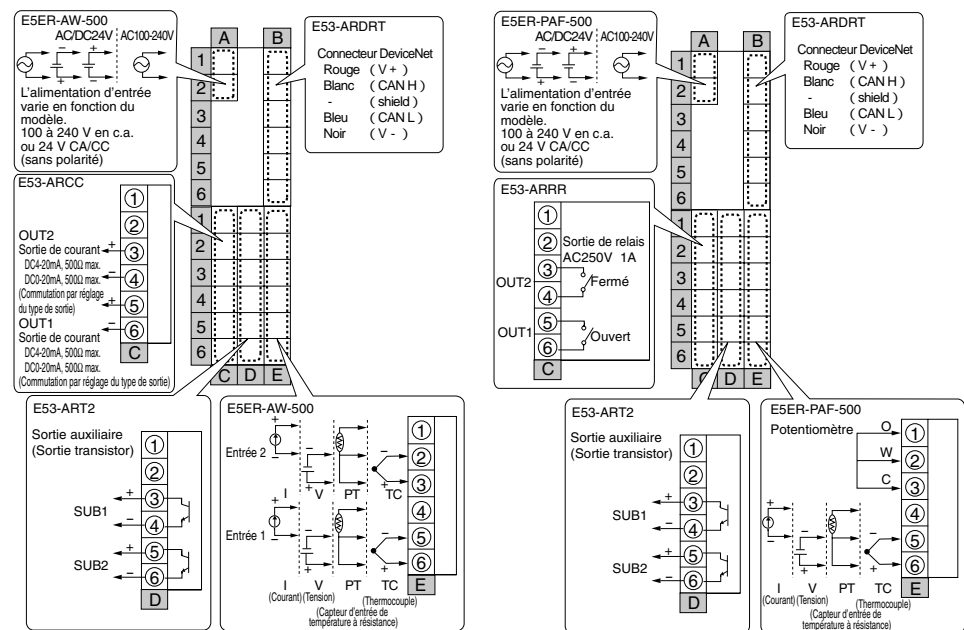
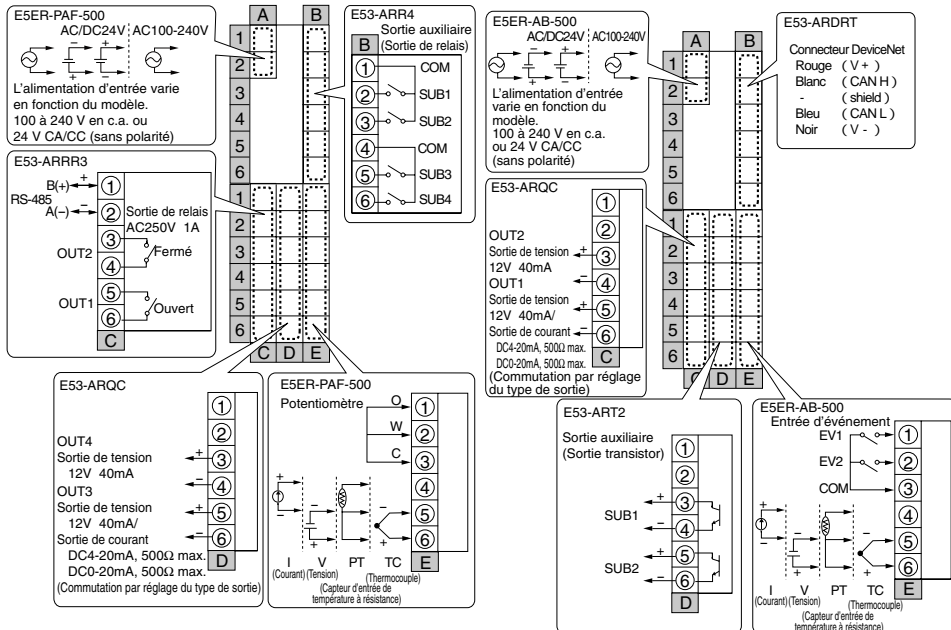

# Collegamenti (E5ER)

E5ER-Q4B

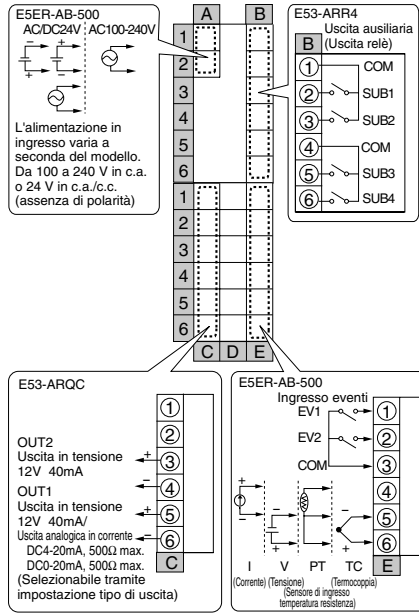

E5ER-C4B

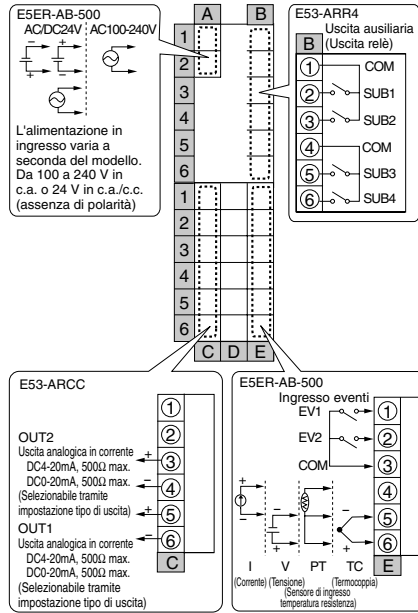

E5ER-QT3DB-FLK

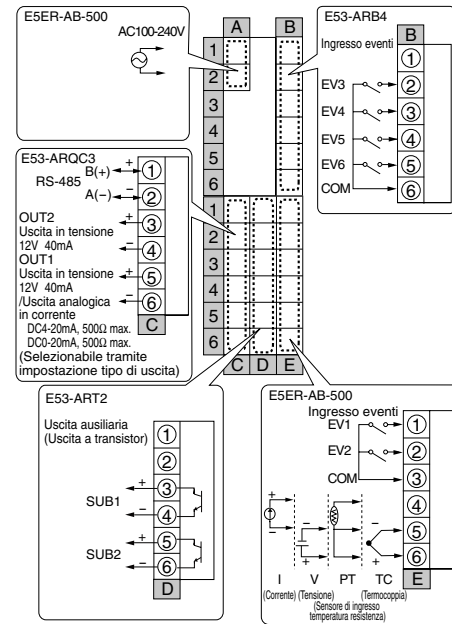

E5ER-CT3DB-FLK

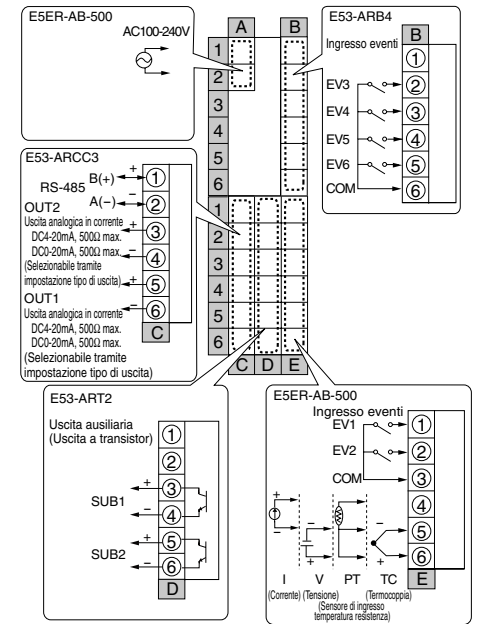

E5ER-Q43B-FLK

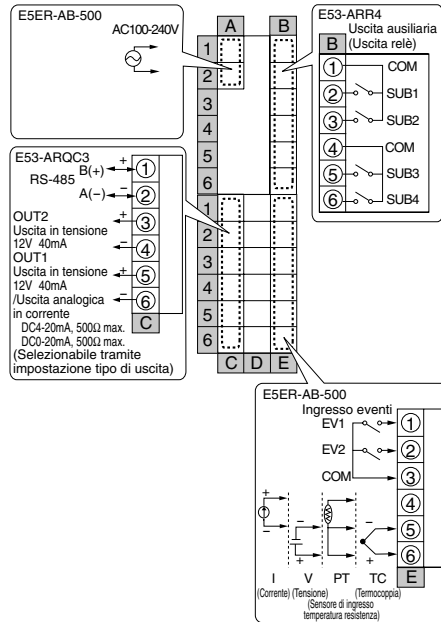

E5ER-C43B-FLK

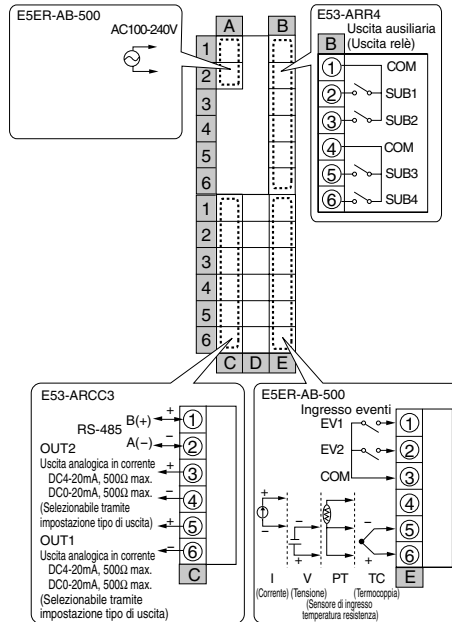

E5ER-QC43B-FLK

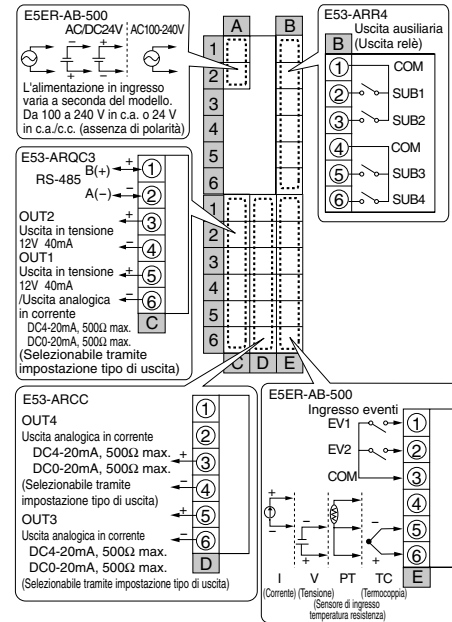

E5ER-QT3DW-FLK (Tipo a 2 ingressi)

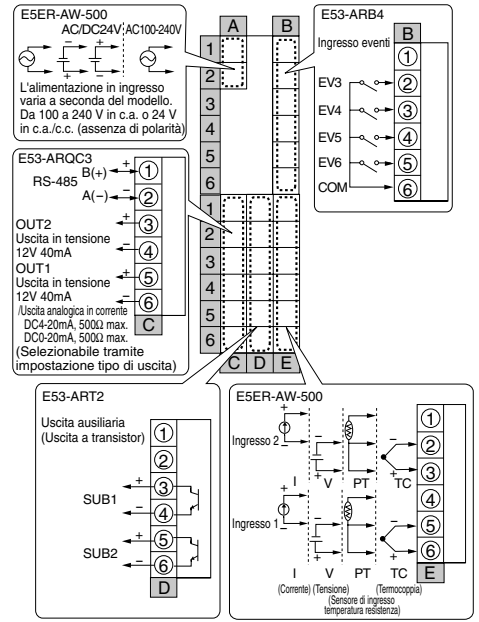

### E5ER-CT3DW-FLK (Tipo a 2 ingressi)

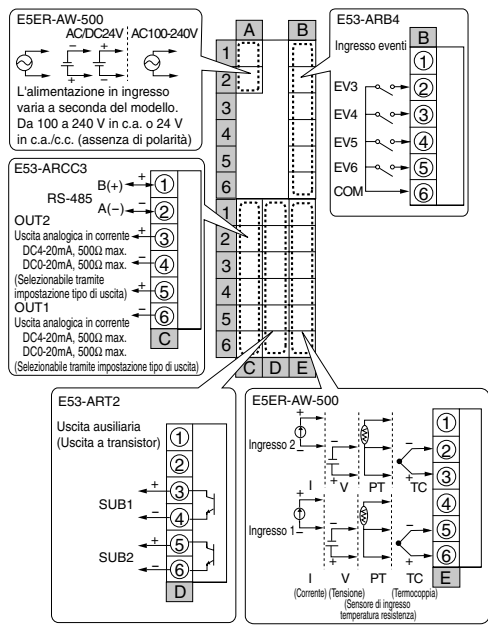

### E5ER-PRTFD

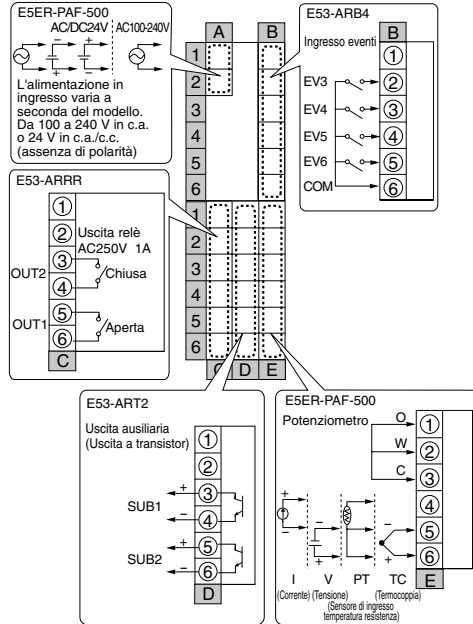

### E5ER-CTB-DRT

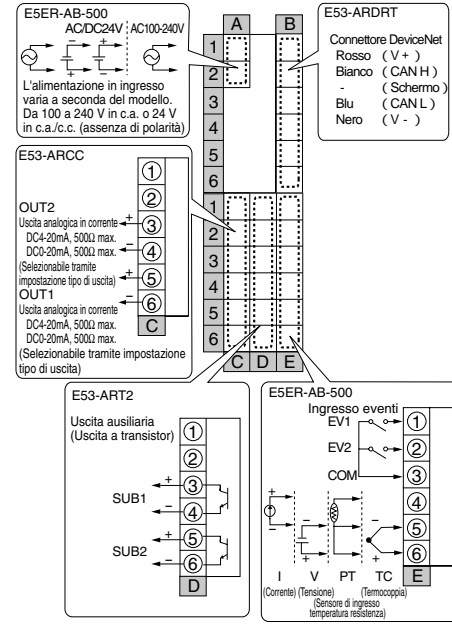

### E5ER-QTW-DRT (Tipo a 2 ingressi)

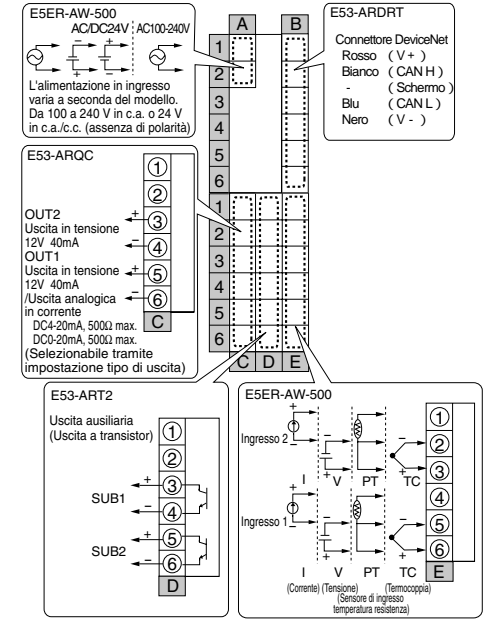

### E5ER-PRQ43F-FLK

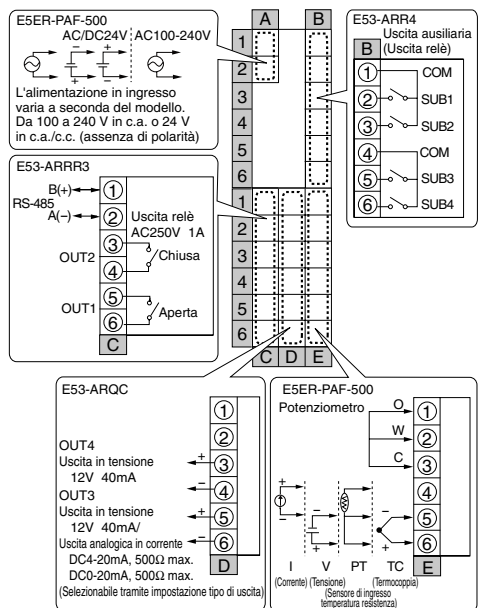

### E5ER-QTB-DRT

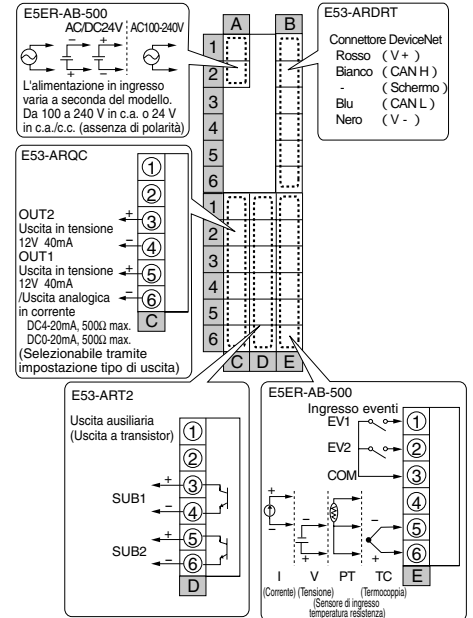

### E5ER-CTW-DRT (Tipo a 2 ingressi)

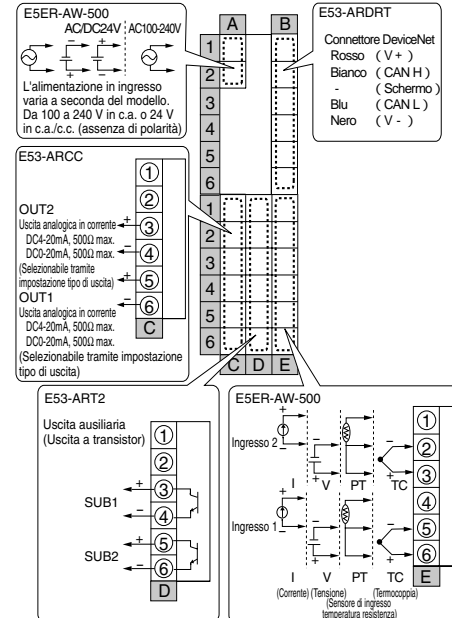

### E5ER-PRTF-DRT

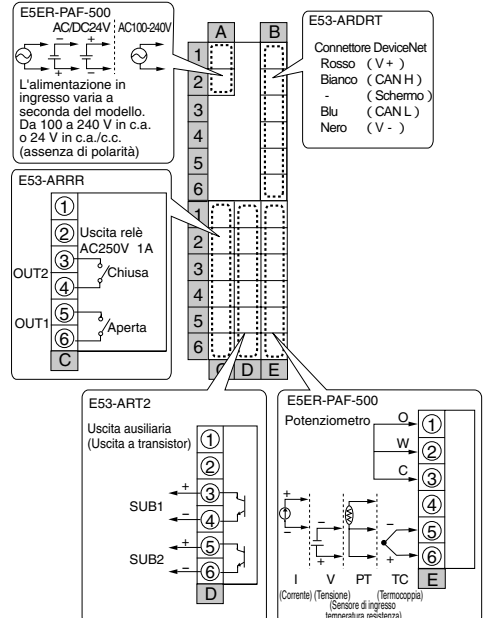

# Conexiones (E5ER)

E5ER-Q4B

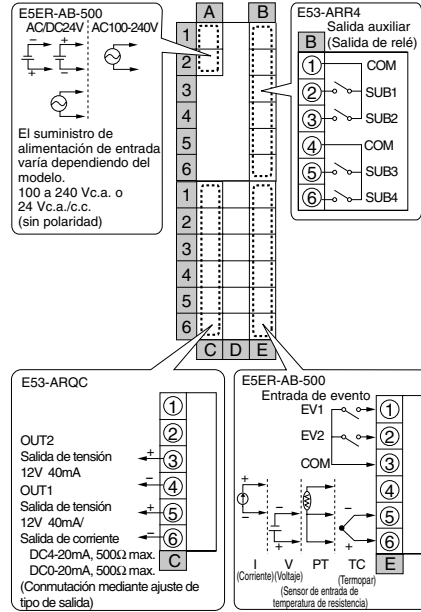

E5ER-C4B

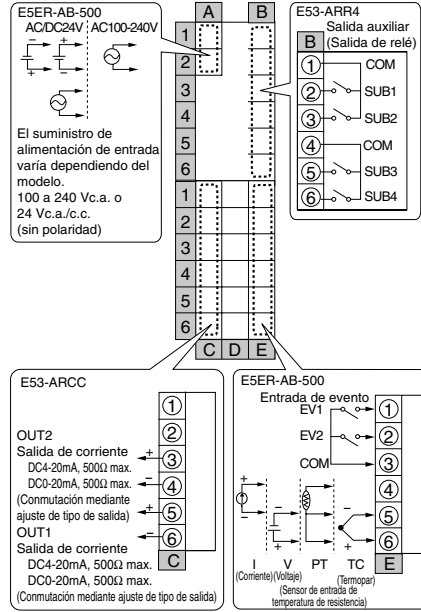

E5ER-QT3DB-FLK

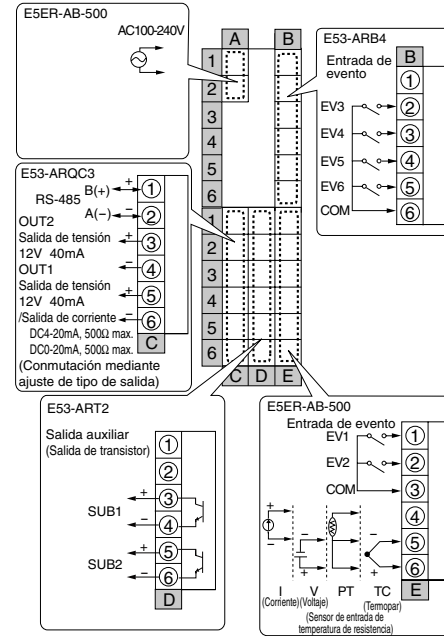

E5ER-CT3DB-FLK

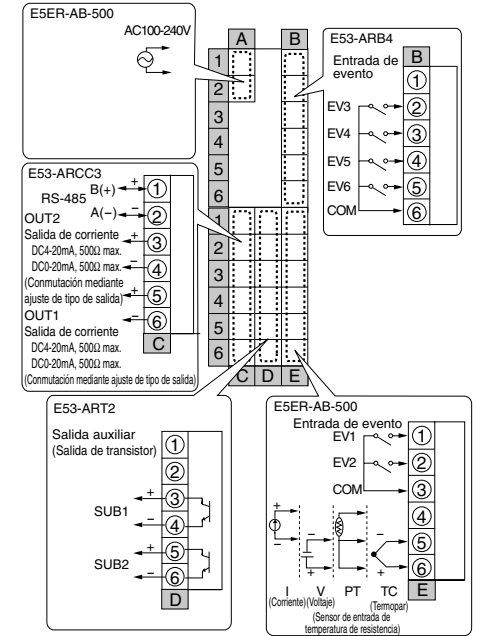

E5ER-Q43B-FLK

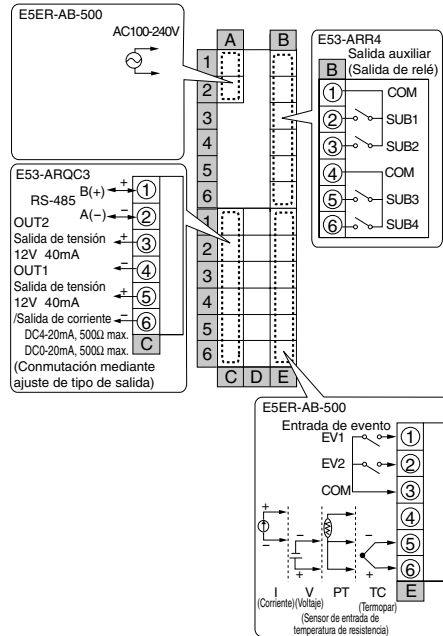

E5ER-C43B-FLK

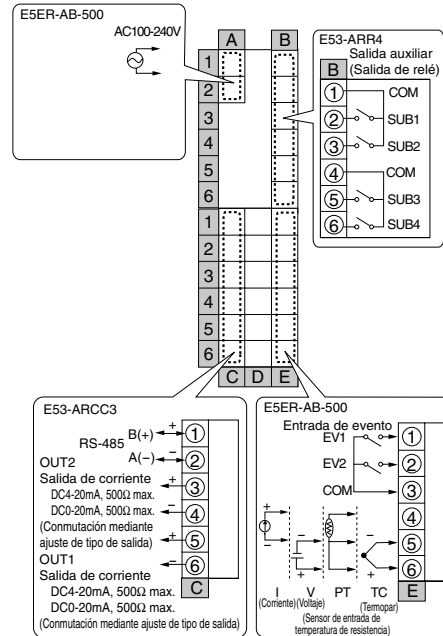

E5ER-QC43B-FLK

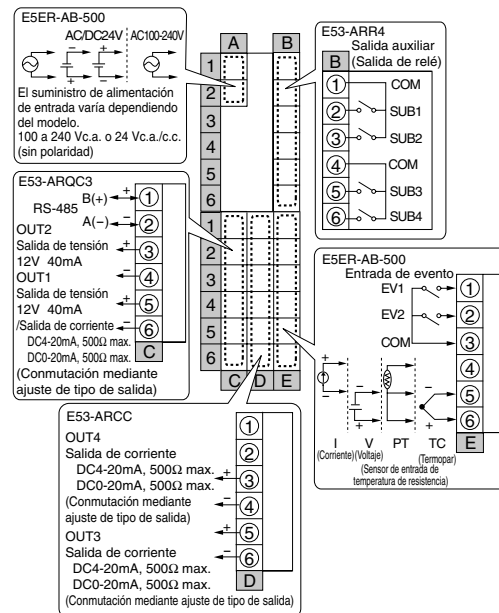

E5ER-QT3DW-FLK (tipo 2 entradas)

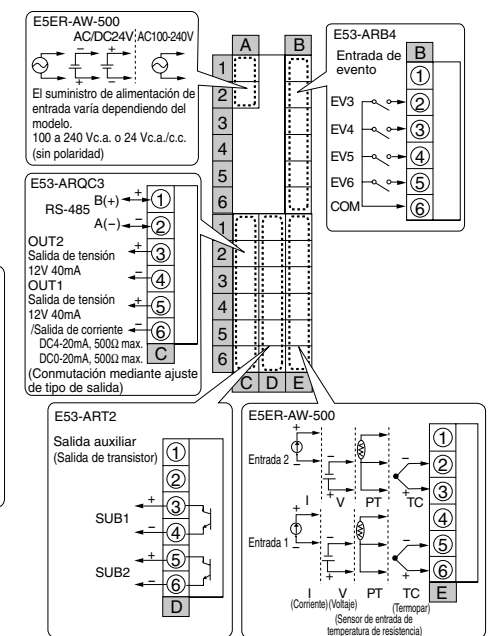



E5ER-CT3DW-FLK (tipo 2 entradas)

E5ER-PRTF

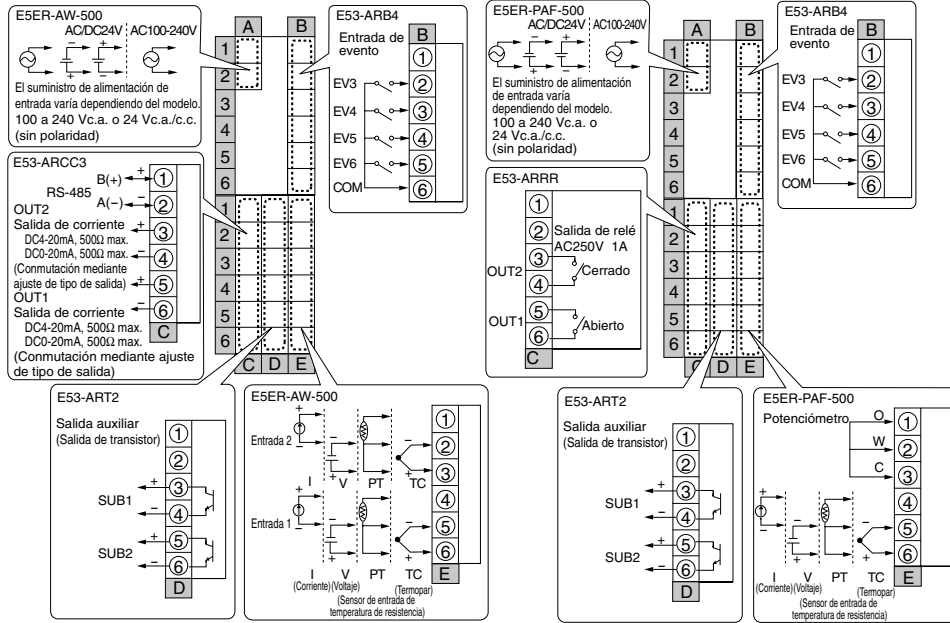

E5ER-CTB-DRT

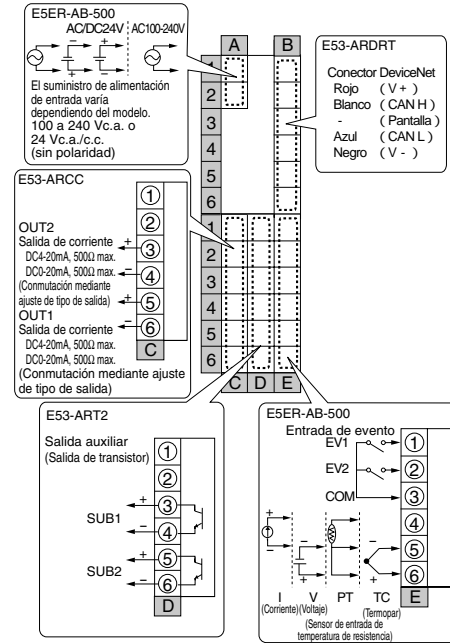

E5ER-QTW-DRT (tipo 2 entradas)

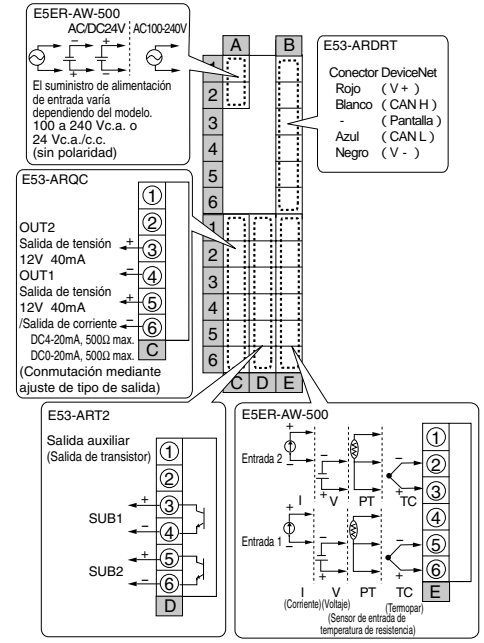

E5ER-PRQ43F-FLK

E5ER-QTB-DRT

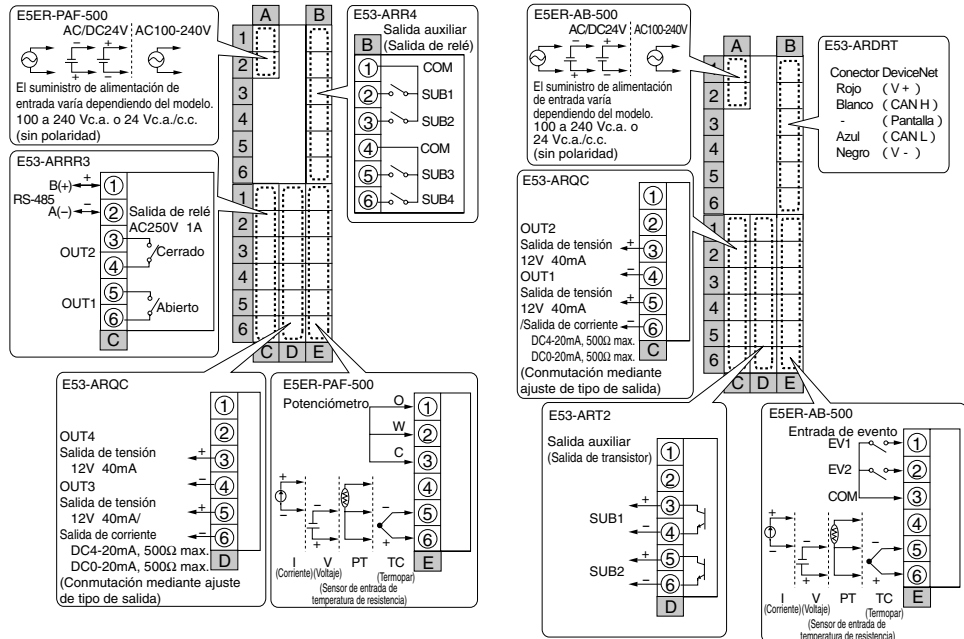

E5ER-CTW-DRT (tipo 2 entradas)

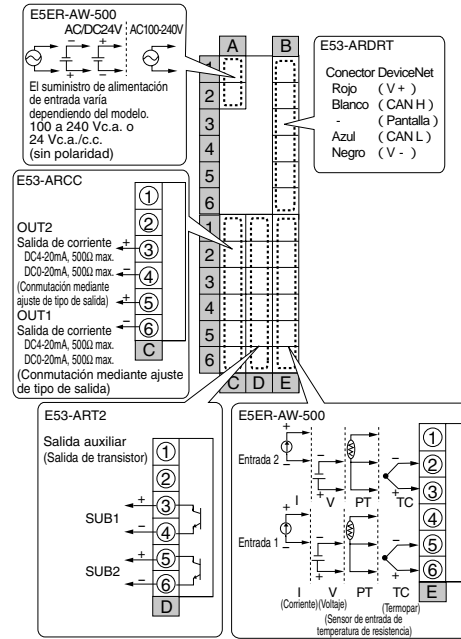

E5ER-PRTF-DRT

