

**Programmable Multi-Axis Controller**

# **Startup Guide for Sinusoidal Encoder**

**CK3W-AX2□2□□**

**Startup  
Guide**

## **NOTE**

1. All rights reserved. No part of this publication may be reproduced, stored in a retrieval system, or transmitted, in any form, or by any means, mechanical, electronic, photocopying, recording, or otherwise, without the prior written permission of OMRON.
2. No patent liability is assumed with respect to the use of the information contained herein.  
Moreover, because OMRON is constantly striving to improve its high-quality products, the information contained in this manual is subject to change without notice.
3. Every precaution has been taken in the preparation of this manual. Nevertheless, OMRON assumes no responsibility for errors or omissions.  
Neither is any liability assumed for damages resulting from the use of the information contained in this publication.

## **Trademarks**

- Microsoft, Windows, Excel, Visual Basic, and Microsoft Edge are either registered trademarks or trademarks of Microsoft Corporation in the United States and other countries.
- EtherCAT® is registered trademark and patented technology, licensed by Beckhoff Automation GmbH, Germany.

Other company names and product names in this document are the trademarks or registered trademarks of their respective companies.

## **Copyrights**

- Microsoft product screen shots used with permission from Microsoft.
- This product incorporates certain third party software. The license and copyright information associated with this software is available at [http://www.fa.omron.co.jp/nj\\_info\\_e/](http://www.fa.omron.co.jp/nj_info_e/).

# Sections in this Manual

---

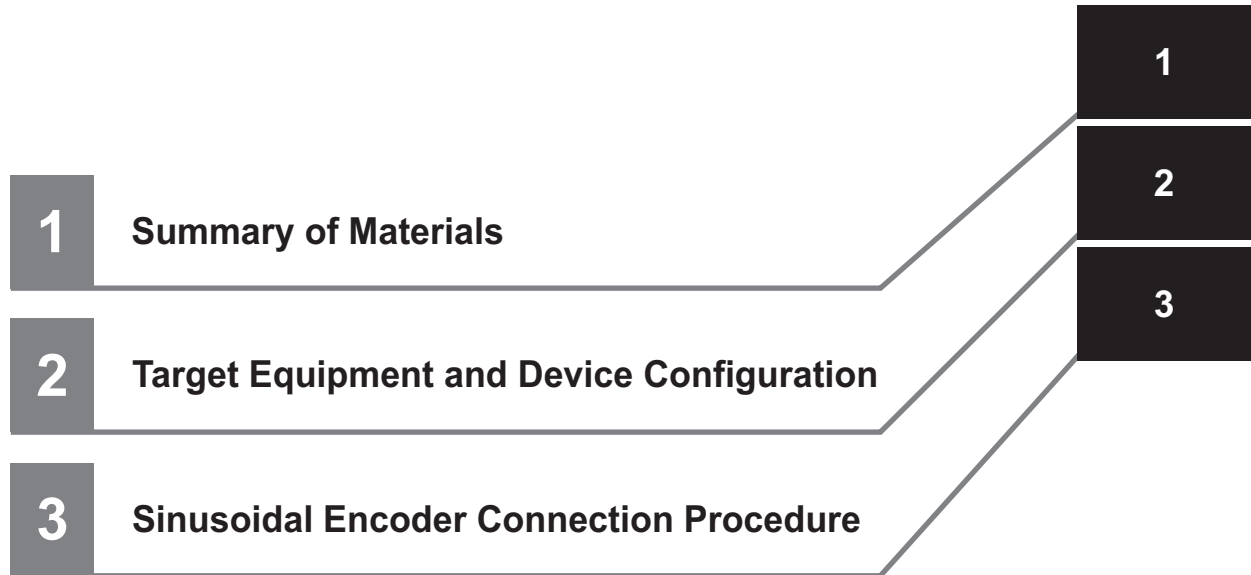

# CONTENTS

---

<b>Sections in this Manual .....</b>	<b>3</b>
<b>Precautions .....</b>	<b>5</b>
<b>Related Manuals.....</b>	<b>6</b>
<b>Terms and Definitions.....</b>	<b>7</b>
<b>Revision History.....</b>	<b>8</b>

## Section 1 About This Guide

---

<b>1-1 Introduction .....</b>	<b>1-2</b>
1-1-1 Intended Audience .....	1-2

## Section 2 Target Equipment and Device Configuration

---

<b>2-1 Device Configuration.....</b>	<b>2-2</b>
--------------------------------------	------------

## Section 3 Sinusoidal Encoder Connection Procedure

---

<b>3-1 Work Flow.....</b>	<b>3-2</b>
<b>3-2 Controller Setting Preparations.....</b>	<b>3-3</b>
3-2-1 Creation of a New Project .....	3-3
3-2-2 Controller Initial Setting .....	3-4
<b>3-3 Sinusoidal Encoder Wiring .....</b>	<b>3-6</b>
<b>3-4 Various Controller Settings and Checking Operation .....</b>	<b>3-7</b>

# Precautions

---

- For actual system construction, check the specifications for each device and piece of equipment that makes up the system, use a method with sufficient margin for ratings and performance, and adopt safety circuits and other safety measures to minimize risks even if a breakdown occurs.
- To safely utilize the system, obtain a manual or user's guide for each device and piece of equipment that makes up the system, confirm and understand their content, including "Safety Precautions", "Precautions for Safe Use", and other precautions related to safety, and then proceed with use.
- The customer must check all regulations, laws, and rules that are applicable to the system themselves.
- Copying, duplication, or redistribution of part or all of these materials without the permission of OMRON Corporation is prohibited.
- The content listed in these materials may be changed without notice for purposes of improvement.

The marks used in these materials are defined as follows.



## **Precautions for Correct Use**

---

Precautions on what to do and what not to do to ensure correct operation and performance.

---



## **Additional Information**

---

Additional information to read as required.

This information is provided to increase understanding and make operation easier.

---

## Related Manuals

To safely utilize the system, obtain a manual or user's guide for each device and piece of equipment, confirm their content, including "Safety Precautions", "Precautions for Safe Use", and other precautions related to safety, and then proceed with use.

The manuals for OMRON Corporation (hereafter, "OMRON") and Delta Tau Data Systems Inc. (hereafter "DT") are as shown below.

Manufacturer	Cat. No.	Model	Manual Name
OMRON	O036	CK5M-□ CK3M-□ CK3W-□	Programmable Multi-Axis Controller Hardware User's Manual
DT	O014	---	Power PMAC User's Manual
DT	O015	---	Power PMAC Software Reference Manual
DT	O016	---	Power PMAC IDE User's Manual

# Terms and Definitions

---

Terms	Descriptions and Definitions
PMAC	This is the acronym for Programmable Multi-Axis Controller.
Power PMAC IDE	This is computer software that is used to configure the Motion Controller, create user programs, and perform monitoring.
Sinusoidal Encoder	A type of encoder that outputs SIN/COS waveforms at 1 Vpp.

# Revision History

---

A manual revision code appears as a suffix to the catalog number on the front and back covers.

<b>Cat. No.</b>	<b>O048-E1-02</b>
-----------------	-------------------

↑  
Revision code

Revision code	Revision date	Revised content
01	July 2019	Original production
02	January 2023	<ul style="list-style-type: none"><li>• Revisions due to the addition of the CK5M-CPU1□1</li><li>• Corrected mistakes.</li></ul>





# About This Guide

---

This section lists a summary of these materials.

---

<b>1-1</b>	<b>Introduction .....</b>	<b>1-2</b>
1-1-1	Intended Audience .....	1-2

# 1-1 Introduction

---

This document describes the connecting procedure and confirmation for an OMRON Programmable Multi-Axis Controller CK□M-□□□□(hereinafter referred to as “Controller”) and a sinusoidal encoder. By understanding the setting content and setting procedure points described in *Section 3 Sinusoidal Encoder Connection Procedure* on page 3-1, the Controller can communicate with each Sinusoidal Encoder, and position information can be received.

## 1-1-1 Intended Audience

This guide is intended for the following personnel, who must also have knowledge of electrical systems (electrical or the equivalent).

- Personnel in charge of introducing FA systems.
- Personnel in charge of designing FA systems.
- Personnel in charge of installing and maintaining FA systems.
- Personnel in charge of managing FA systems and facilities.

Also, this guide is intended for personnel who understand the contents described in the DT manual.

# 2

## Target Equipment and Device Configuration

This section lists the target equipment and system configurations for connections in these materials.

---

<b>2-1</b>	<b>Device Configuration .....</b>	<b>2-2</b>
------------	-----------------------------------	------------

# 2-1 Device Configuration

The configuration devices for reproducing the connection procedures in this document are shown below.

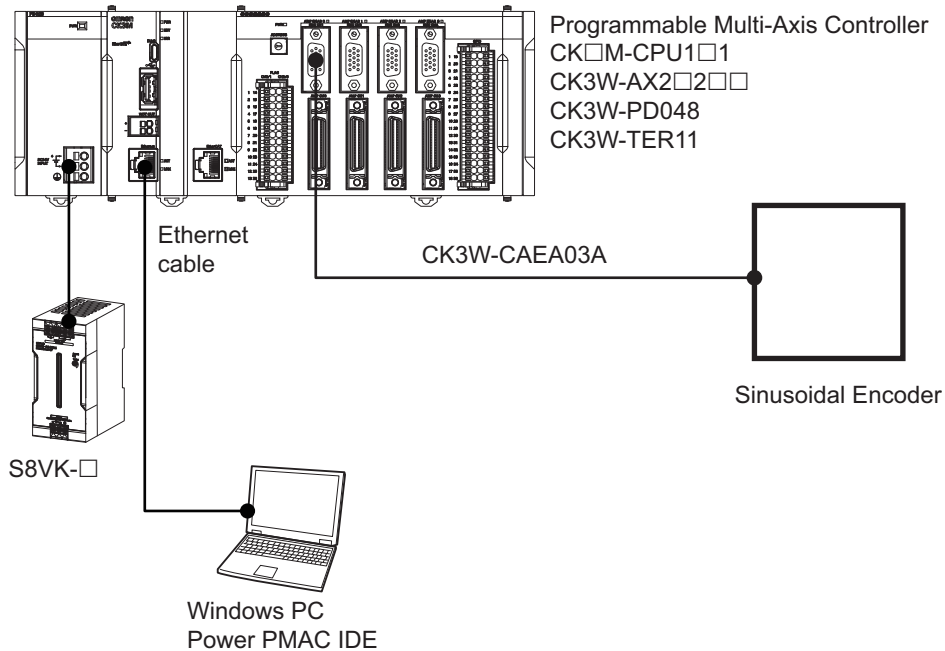

Manufacturer	Name	Model	Version
OMRON	Programmable Multi-Axis Controller CPU Unit	CK□M-CPU1□1	Version 2.5.2 or later
OMRON	Programmable Multi-Axis Controller Axis Interface Unit	CK3W-AX2□2□□	---
OMRON	Programmable Multi-Axis Controller Power Supply Unit	CK3W-PD048	---
OMRON	Programmable Multi-Axis Controller End Cover	CK3W-TER11	---
OMRON	Switch Mode Power Supply	S8VK-□	---
OMRON	Encoder Cable	CK3W-CAEA03A	---
HEIDENHAIN	Sinusoidal Encoder	ROD480-5000	---
---	Windows PC	---	---
DT	Power PMAC Setting Tool	Power PMAC IDE	Version 4.3 or later

# 3

## Sinusoidal Encoder Connection Procedure

This section describes the procedures to connect the Controller and Sinusoidal Encoder. The description assumes that the Controller is set to factory default.

---

<b>3-1</b>	<b>Work Flow .....</b>	<b>3-2</b>
<b>3-2</b>	<b>Controller Setting Preparations .....</b>	<b>3-3</b>
3-2-1	Creation of a New Project .....	3-3
3-2-2	Controller Initial Setting .....	3-4
<b>3-3</b>	<b>Sinusoidal Encoder Wiring.....</b>	<b>3-6</b>
<b>3-4</b>	<b>Various Controller Settings and Checking Operation .....</b>	<b>3-7</b>

## 3-1 Work Flow

The procedures for connecting the Controller and Sinusoidal Encoder are shown below.

<b>3-2 Controller Setting Preparations on page 3-3</b>	Perform the Controller setting preparations.
▼	
3-2-1 Creation of a New Project on page 3-3	
▼	
3-2-2 Controller Initial Setting on page 3-4	
▼	
<b>3-3 Sinusoidal Encoder Wiring on page 3-6</b>	Perform wiring for each device.
▼	
<b>3-4 Various Controller Settings and Checking Operation on page 3-7</b>	Perform the Controller settings and operation check.

## 3-2 Controller Setting Preparations

Perform the Controller setting preparations.  
Install the Power PMAC IDE on the PC beforehand.

### 3-2-1 Creation of a New Project

Follow the procedure below to create a new project.

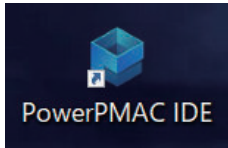
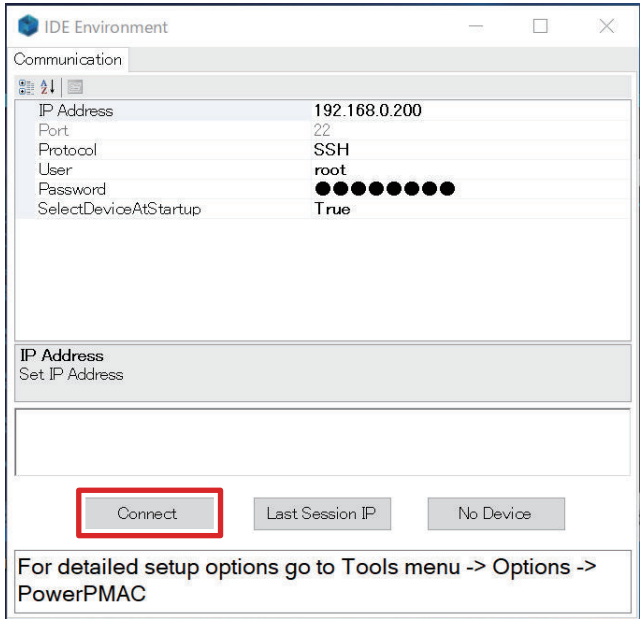
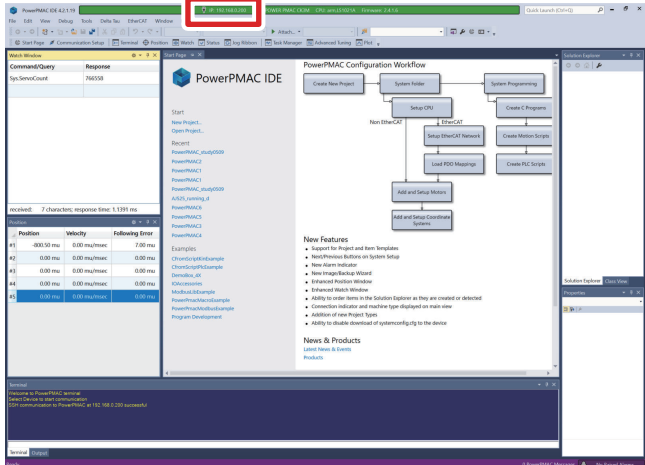
<b>1</b>	Connect the Controller and computer with an Ethernet cable.	
<b>2</b>	Turn ON the power supply to the Controller.	
<b>3</b>	Start up Power PMAC IDE. <ul style="list-style-type: none"> <li>If a dialog for checking access rights is displayed at the time of startup, select the option for starting up.</li> </ul>	
<b>4</b>	The Communication screen is displayed, so specify the IP address of the Controller to be connected to, and click the <b>Connect</b> button. <ul style="list-style-type: none"> <li>The default IP address for the Controller is "192.168.0.200".</li> <li>If necessary, change the Windows IP address to "192.168.0.X".</li> </ul>	 <p>For detailed setup options go to Tools menu -&gt; Options -&gt; PowerPMAC</p>
<b>5</b>	Power PMAC IDE starts up, and the Controller will come online.	

**6** From the **File** menu, select **New – Project**.

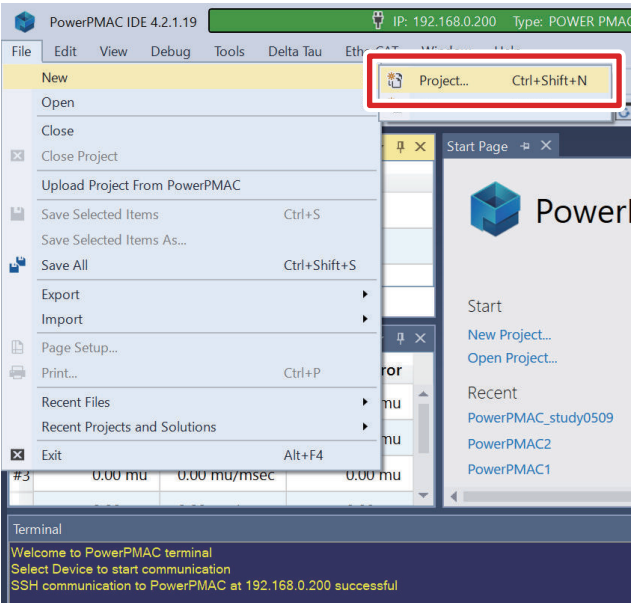

**7** Input a project name and save destination, and select the **OK** button.

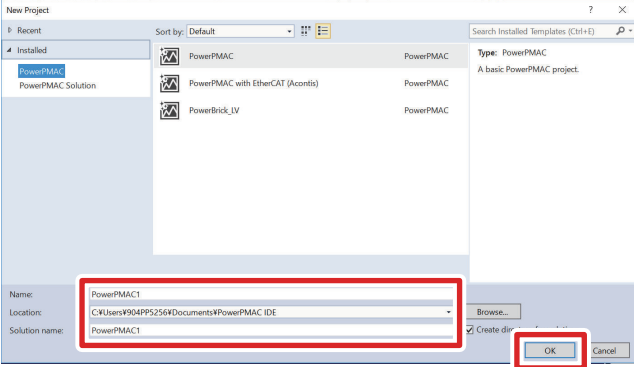

## 3-2-2 Controller Initial Setting

Follow the procedure below to perform the initial settings for the Controller.



### Precautions for Correct Use

Since all memory is cleared by the initial settings, be sure to save any data remaining in the Controller that you may need.

**1** Type the **\$\$\$\*\*\*** command from the Terminal, and set the Controller to the factory default state.

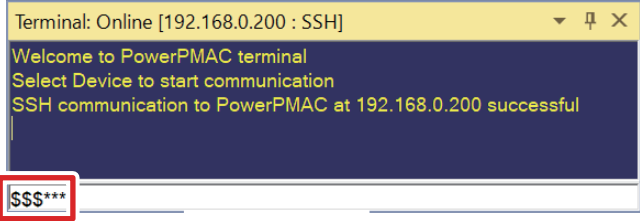

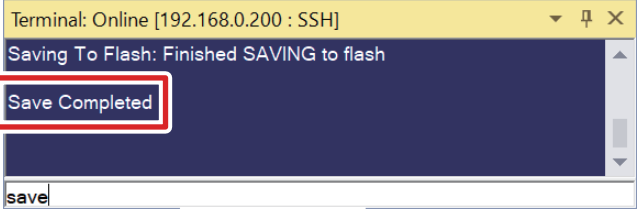
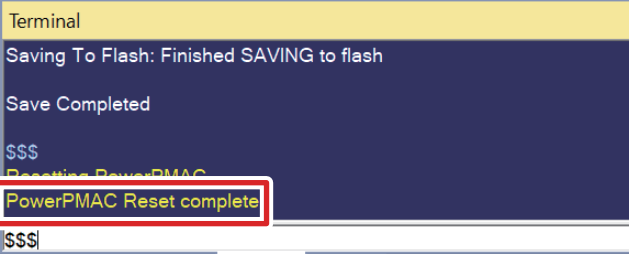

<p><b>2</b></p>	<p>Type the <b>save</b> command in the Power PMAC IDE Terminal.</p> <ul style="list-style-type: none"> <li>When the save is completed, "Save Completed" is displayed in the Terminal.</li> </ul>	 <p>Terminal: Online [192.168.0.200 : SSH]</p> <p>Saving To Flash: Finished SAVING to flash</p> <p>Save Completed</p> <p>save</p>
<p><b>3</b></p>	<p>Type the <b>\$\$\$</b> command in the Power PMAC IDE Terminal.</p> <ul style="list-style-type: none"> <li>When the reset is completed, "PowerPMAC Reset complete" is displayed in the Terminal.</li> </ul>	 <p>Terminal</p> <p>Saving To Flash: Finished SAVING to flash</p> <p>Save Completed</p> <p>\$\$\$</p> <p>Resetting PowerPMAC</p> <p>PowerPMAC Reset complete</p> <p>\$\$\$</p>

# 3-3 Sinusoidal Encoder Wiring

Perform wiring for the Axis Interface Unit and Sinusoidal Encoder in accordance with the wiring diagram below.

CK3W-AX2□□2□□  
Encoder Connector

Signal	Pin No.	Type	Cable color
Encoder Power Supply (+5VDC)	11	pair1	Black
Encoder Power Supply (GND)	13		Blue
Sinusoidal Encoder SIN+	1	pair2	Black
Sinusoidal Encoder SIN-	6		Red
Sinusoidal Encoder COS+	2	pair3	Black
Sinusoidal Encoder COS-	7		White
Sinusoidal Encoder INDEX+	3	pair4	Black
Sinusoidal Encoder INDEX-	8		Green

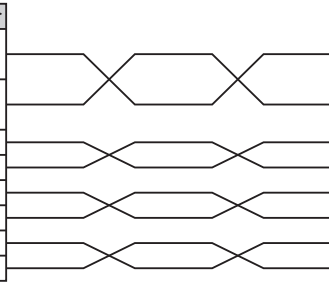

Sinusoidal Encoder	
Color	Signal
Brown/Green	Up
Blue	Sensor/Up
White/Green	0V
White	Sensor/0V
Brown	A+
Green	A-
Gray	B+
Pink	B-
Red	R+
Black	R-

## 3-4 Various Controller Settings and Checking Operation

Perform the settings for connecting the Controller to the Sinusoidal Encoder.

**1** Open the global definitions.pmh under **PMAC Script Language – Global Includes** in the Solution Explorer.

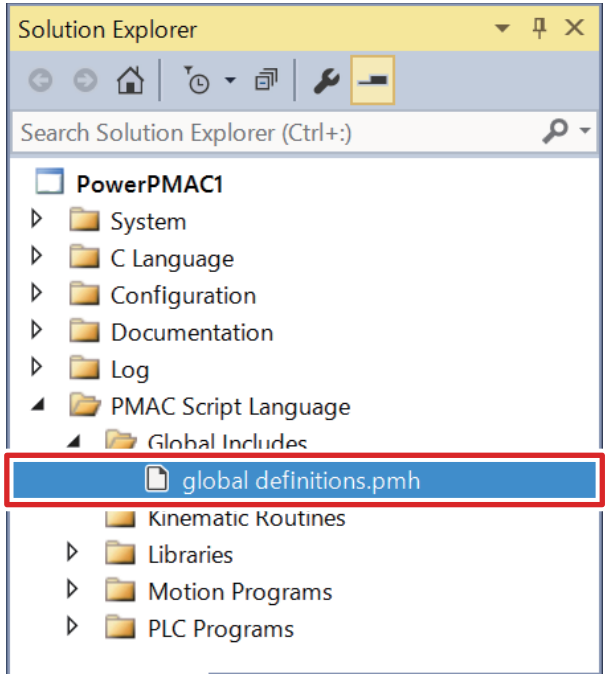

**2**

Write the text on the right to the global definitions.pmh.

- To use the hardware-interpolated sinusoidal encoder position

```

Sys.WpKey = $AAAAAAAA //Release write-protect

//Default setting Sinusoidal Encoder*1
Gate3[0].EncClockDiv = 3
Gate3[0].AdcEncClockDiv = 3
Gate3[0].AdcEncCtrl = $3FFFC000

//Enable Sinusoidal Encoder
Gate3[0].Chan[0].AtanEna = 1
Motor[1].ServoCtrl = 1

//Setting Encoder table
EncTable[1].type = 1
EncTable[1].pEnc = Gate3[0].Chan[0].ServoCapt.a
EncTable[1].index1 = 0
EncTable[1].index2 = 0
EncTable[1].ScaleFactor = 1/4096
Motor[1].pEnc = EncTable[1].a
Motor[1].pEnc2 = EncTable[1].a

Sys.WpKey = $0 //Write-protect

```

- \*1. Do not change the setting by which Sinusoidal Encoder values can be received correctly.

- To use software-based arctangent interpolated position

```

Sys.WpKey = $AAAAAAAA //Release write-protect

//Default setting Sinusoidal Encoder*1
Gate3[0].EncClockDiv = 3
Gate3[0].AdcEncClockDiv = 3
Gate3[0].AdcEncCtrl = $3FFFC000

//Enable Sinusoidal Encoder
Gate3[0].Chan[0].AtanEna = 0
Motor[1].ServoCtrl = 1

//Setting Encoder table
EncTable[1].type = 4
EncTable[1].pEnc = Gate3[0].Chan[0].Status.a
EncTable[1].pEnc1 = Gate3[0].Chan[0].AdcEnc[0].a
EncTable[1].index3 = 0
EncTable[1].index5 = 1
EncTable[1].ScaleFactor = 1/65536
Motor[1].pEnc = EncTable[1].a
Motor[1].pEnc2 = EncTable[1].a

//Setting correction factor value*2
EncTable[1].SinBias
EncTable[1].CosBias
EncTable[1].CoverSerror
EncTable[1].TanHalfPhi

Sys.WpKey = $0 //Write-protect

```

- \*1. Do not change the setting by which Sinusoidal Encoder values can be received correctly.
- \*2. Set values other than 0 to correct incompleteness of signals. For details on the settings, refer to DT's *Power PMAC User's Manual (Cat. No. O014)*, **SETTING UP THE ENCODER CONVERSION TABLE – Conversion Method Details – Type 4: Software Arctangent Sinusoidal Encoder Extension**.

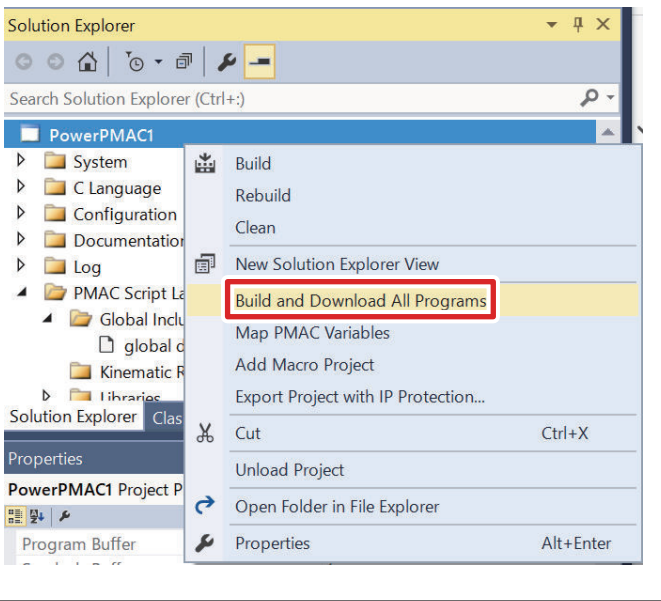
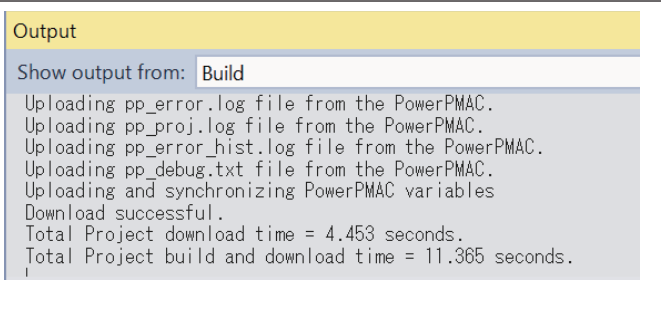
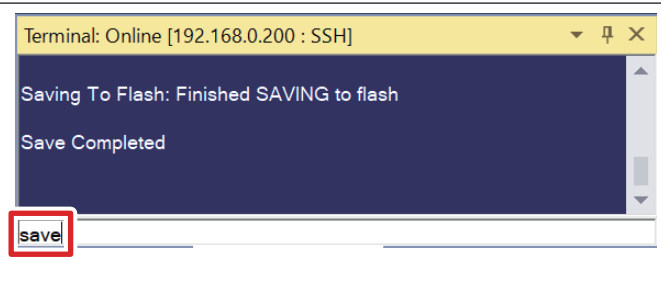
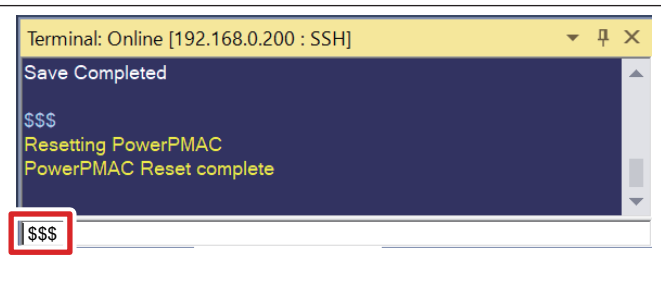
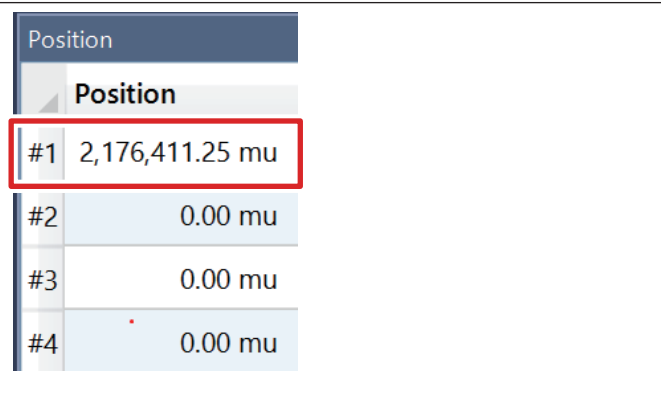
<p><b>3</b></p>	<p>Right click on the <b>Solution Explorer</b> project name at the upper right of the Power PMAC IDE screen, select <b>Build and Download All Programs</b>, and execute Build and Download.</p>											
<p><b>4</b></p>	<p>Make sure that there are no errors in the Output Window.</p> <ul style="list-style-type: none"> <li>If the transfer failed, check the content of the error in the Output Window. If there is a program error, fix the program.</li> </ul>											
<p><b>5</b></p>	<p>Type the <b>save</b> command in the Power PMAC IDE Terminal.</p> <ul style="list-style-type: none"> <li>When the save is completed, "Save Completed" is displayed in the Terminal.</li> </ul>											
<p><b>6</b></p>	<p>Type the <b>\$\$\$</b> command in the Terminal.</p>											
<p><b>7</b></p>	<p>Check that the value in the Power PMAC IDE position window is changed by rotating the encoder.</p>	 <table border="1" data-bbox="783 1709 1447 2107"> <thead> <tr> <th colspan="2">Position</th> </tr> </thead> <tbody> <tr> <td>#1</td> <td>2,176,411.25 mu</td> </tr> <tr> <td>#2</td> <td>0.00 mu</td> </tr> <tr> <td>#3</td> <td>0.00 mu</td> </tr> <tr> <td>#4</td> <td>0.00 mu</td> </tr> </tbody> </table>	Position		#1	2,176,411.25 mu	#2	0.00 mu	#3	0.00 mu	#4	0.00 mu
Position												
#1	2,176,411.25 mu											
#2	0.00 mu											
#3	0.00 mu											
#4	0.00 mu											



### Precautions for Correct Use

---

If the **save** command is not successfully completed, the transferred project is not saved in the Controller. If the power to the Controller is switched OFF without the project being saved, the transferred project is destroyed.

---







## **OMRON Corporation Industrial Automation Company**

**Kyoto, JAPAN**

**Contact : [www.ia.omron.com](http://www.ia.omron.com)**

### **Regional Headquarters**

#### **OMRON EUROPE B.V.**

Wegalaan 67-69, 2132 JD Hoofddorp  
The Netherlands

Tel: (31) 2356-81-300 Fax: (31) 2356-81-388

#### **OMRON ASIA PACIFIC PTE. LTD.**

438B Alexandra Road, #08-01/02 Alexandra  
Technopark, Singapore 119968

Tel: (65) 6835-3011 Fax: (65) 6835-2711

#### **OMRON ELECTRONICS LLC**

2895 Greenspoint Parkway, Suite 200  
Hoffman Estates, IL 60169 U.S.A.

Tel: (1) 847-843-7900 Fax: (1) 847-843-7787

#### **OMRON (CHINA) CO., LTD.**

Room 2211, Bank of China Tower,  
200 Yin Cheng Zhong Road,  
PuDong New Area, Shanghai, 200120, China

Tel: (86) 21-5037-2222 Fax: (86) 21-5037-2200

**Authorized Distributor:**

©OMRON Corporation 2019 - 2023 All Rights Reserved.  
In the interest of product improvement,  
specifications are subject to change without notice.

**Cat. No. 0048-E1-02** 0123