

EQUO Series

Differential Pressure Station

ZN-DPX21-S□

Thermo-Humidity Station

ZN-THX21-S□

Air Thermo Logger

ZN-THX11-S□



User's Manual

Introduction

Thank you for purchasing EQUO Series Differential Pressure Station ZN-DPX21-S□, Thermo-Humidity Station ZN-THX21-S□ and Air Thermo Logger ZN-THX11-S□.

This manual describes the information regarding the functions, performance and usage that are necessary to use the products.

Please observe the following when using the unit:

- This product must be handled by specialists with electrical knowledge.
- Read this User's Manual thoroughly to be familiar with the product beforehand for correct operation.
- Keep this manual properly for future reference.

Trademarks

- Microsoft and Windows are registered trademarks or trademarks of Microsoft Corporation in the United States and other countries.
- Other company names and product names are registered trademarks or trademarks of the respective company.

Manual Type and Usage

The major contents of the manuals are shown below. Select and read the manual according to your need.

Included Manuals (Print)

Instruction Sheet

Describes the information to ensure the safe and proper use of the product, and information regarding ratings, performance and installation.

Startup Guide

Describes the basic procedures including the package content check, assembly, setting operation, recording operation and data display.

Manuals available from Website (PDF data)

User's Manual (This document)

Describes information to ensure the safe and proper use of the product.

Describes package content items and detailed procedures for assembly, setting operation, recording operation and data display.

Describes in detail product specifications and other necessary information required to use the product.

Multi Data Viewer Light S Manual

Describes the information of the functions and usage of the PC software, Multi Data Viewer Light.

Terms and Conditions Agreement

Warranties.

(a) **Exclusive Warranty.** Omron's exclusive warranty is that the Products will be free from defects in materials and workmanship for a period of twelve months from the date of sale by Omron (or such other period expressed in writing by Omron). Omron disclaims all other warranties, express or implied.

(b) **Limitations.** OMRON MAKES NO WARRANTY OR REPRESENTATION, EXPRESS OR IMPLIED, ABOUT NON-INFRINGEMENT, MERCHANTABILITY OR FITNESS FOR A PARTICULAR PURPOSE OF THE PRODUCTS. BUYER ACKNOWLEDGES THAT IT ALONE HAS DETERMINED THAT THE PRODUCTS WILL SUITABLY MEET THE REQUIREMENTS OF THEIR INTENDED USE.

Omron further disclaims all warranties and responsibility of any type for claims or expenses based on infringement by the Products or otherwise of any intellectual property right.

(c) **Buyer Remedy.** Omron's sole obligation hereunder shall be, at Omron's election, to (i) replace (in the form originally shipped with Buyer responsible for labor charges for removal or replacement thereof) the non-complying Product, (ii) repair the non-complying Product, or (iii) repay or credit Buyer an amount equal to the purchase price of the non-complying Product; provided that in no event shall Omron be responsible for warranty, repair, indemnity or any other claims or expenses regarding the Products unless Omron's analysis confirms that the Products were properly handled, stored, installed and maintained and not subject to contamination, abuse, misuse or inappropriate modification. Return of any Products by Buyer must be approved in writing by Omron before shipment. Omron Companies shall not be liable for the suitability or unsuitability or the results from the use of Products in combination with any electrical or electronic components, circuits, system assemblies or any other materials or substances or environments. Any advice, recommendations or information given orally or in writing, are not to be construed as an amendment or addition to the above warranty.

See <http://www.omron.com/global/> or contact your Omron representative for published information.

Limitation on Liability; Etc.

OMRON COMPANIES SHALL NOT BE LIABLE FOR SPECIAL, INDIRECT, INCIDENTAL, OR CONSEQUENTIAL DAMAGES, LOSS OF PROFITS OR PRODUCTION OR COMMERCIAL LOSS IN ANY WAY CONNECTED WITH THE PRODUCTS, WHETHER SUCH CLAIM IS BASED IN CONTRACT, WARRANTY, NEGLIGENCE OR STRICT LIABILITY.

Further, in no event shall liability of Omron Companies exceed the individual price of the Product on which liability is asserted.

Suitability of Use.

Omron Companies shall not be responsible for conformity with any standards, codes or regulations which apply to the combination of the Product in the Buyer's application or use of the Product. At Buyer's request, Omron will provide applicable third party certification documents identifying ratings and limitations of use which apply to the Product. This information by itself is not sufficient for a complete determination of the suitability of the Product in combination with the end product, machine, system, or other application or use. Buyer shall be solely responsible for determining appropriateness of the particular Product with respect to Buyer's application, product or system. Buyer shall take application responsibility in all cases.

NEVER USE THE PRODUCT FOR AN APPLICATION INVOLVING SERIOUS RISK TO LIFE OR PROPERTY OR IN LARGE QUANTITIES WITHOUT ENSURING THAT THE SYSTEM AS A WHOLE HAS BEEN DESIGNED TO ADDRESS THE RISKS, AND THAT THE OMRON PRODUCT(S) IS PROPERLY RATED AND INSTALLED FOR THE INTENDED USE WITHIN THE OVERALL EQUIPMENT OR SYSTEM.

Programmable Products.

Omron Companies shall not be responsible for the user's programming of a programmable Product, or any consequence thereof.

Performance Data.

Data presented in Omron Company websites, catalogs and other materials is provided as

a guide for the user in determining suitability and does not constitute a warranty. It may represent the result of Omron's test conditions, and the user must correlate it to actual application requirements. Actual performance is subject to the Omron's Warranty and Limitations of Liability.

Change in Specifications.

Product specifications and accessories may be changed at any time based on improvements and other reasons. It is our practice to change part numbers when published ratings or features are changed, or when significant construction changes are made. However, some specifications of the Product may be changed without any notice. When in doubt, special part numbers may be assigned to fix or establish key specifications for your application. Please consult with your Omron's representative at any time to confirm actual specifications of purchased Product.

Errors and Omissions.

Information presented by Omron Companies has been checked and is believed to be accurate; however, no responsibility is assumed for clerical, typographical or proofreading errors or omissions.

Precautions on Safety



● Meanings of Signal Words

For the safe operation of the unit, this operation manual indicates the precautions by using the marks and symbols as indicated below. The precautions given here contains important information related to safety. Be sure to observe them. The marks and symbols for the safety precautions are as follows:



 <b style="font-size: 1.2em; margin-left: 10px;">WARNING	<p>Indicates a potentially hazardous situation which, if not avoided, will result in minor or moderate injury, or may result in serious injury or death. Additionally there may be significant property damage.</p>
---	---

 <b style="font-size: 1.2em; margin-left: 10px;">CAUTION	<p>Indicates a potentially hazardous situation which, if not avoided, may result in minor or moderate injury or in property damage.</p>
---	---

● Meanings of Alert Symbols

	<ul style="list-style-type: none"> ● Disassembly Prohibition <p>Indicates that disassembly is prohibited to prevent electric shock.</p>
	<ul style="list-style-type: none"> ● Explosion Caution <p>Indicates the possibility of explosion under specific conditions.</p>
	<ul style="list-style-type: none"> ● General Precaution <p>Indicates the precaution for something that you must do.</p>

● Warning Indications

 <b style="font-size: 1.2em; margin-left: 10px;">WARNING	
<p>As this product contains a lithium battery, fire, explosion or burning hazards may occur. Dispose of the product as industrial waste. Do not disassemble, deform, heat, or burn this product.</p>	
<p>Do not disassemble or touch inside the unit. Doing so may result in electric shock and/or injury.</p>	

Anti-virus protection

Install the latest commercial-quality antivirus software on the computer connected to the control system and maintain to keep the software up-to-date.

**Security measures to prevent unauthorized access**

Take the following measures to prevent unauthorized access to our products.

- Install physical controls so that only authorized personnel can access control systems and equipment.
- Reduce connections to control systems and equipment via networks to prevent access from untrusted devices.
- Install firewalls to shut down unused communications ports and limit communications hosts and isolate control systems and equipment from the IT network.
- Use a virtual private network (VPN) for remote access to control systems and equipment.
- Adopt multifactor authentication to devices with remote access to control systems and equipment.
- Set strong passwords and change them frequently.
- Scan virus to ensure safety of USB drives or other external storages before connecting them to control systems and equipment.

**Data input and output protection**

Validate backups and ranges to cope with unintentional modification of input/output data to control systems and equipment.

- Checking the scope of data.
- Checking validity of backups and preparing data for restore in case of falsification and abnormalities.
- Safety design, such as emergency shutdown and fail-soft operation in case of data tampering and abnormalities.

**Data recovery**

Backup data and keep the data up-to-date periodically to prepare for data loss.



Precautions for Safe Use

Observe the following precautions to ensure safe operation.

- Do not install the product in the places subject to exposure to water, oil, or chemicals.
- When using an AC adapter, use only the attached AC adapter.
- When using a DC power supply cable, use only the attached DC power supply cable.
- If a voltage that exceeds the rated voltage is applied to the AC adapter or DC cable,, smoking may occur. Do not connect a power supply that exceeds the rated voltage. In a situation where a voltage higher than the rating is applied, use protective equipment so that the power supply voltage does not exceed the rated voltage.
- Dispose of the product as industrial waste.
- To use the batteries properly, read the precautions written by manufacturer before use.
- Do not subject the product to a shock such as dropping the product. Doing so may cause damage to or malfunction of the product. It is recommended to secure screws when mounted on the wall surface to prevent damage from dropping the product. If strong impact is applied to the product, stop use of the product.
- When inserting or pulling out the SD memory card, hold the main unit to prevent damage from dropping the product. When inserting or pulling out an AC adapter or DC power supply cable, alarm output cable, sensor connector or LAN cable, hold the unit as well.
- Mount an appropriate load on the alarm output terminals due to the possibility of smoking.
- If liquid crystal leaks due to a damage to the LCD panel, be careful so that your skin will not touch with or you will not inhale or swallow it. If liquid crystal enters into your mouth, seek medical attention.

Precautions for Correct Use

1. Avoid installing the product in the following places:

- Places exceeding the rated ambient temperature
- Places exposed to extreme temperature changes (prevent condensation.)
- Places exceeding the rated RH level
- Places subject to corrosive or flammable gases
- Places subject to mist, droplets, coarse particles, fiber, salt, metal dust, or large amount of particles
- Places subject to direct shock or vibration
- Places subject to direct sunlight
- Places subject to exposure to water, oil, or chemicals
- Places subject to strong magnetic field or electric field
- Outdoors

2. Wiring

- Lay the product cable away from any high-voltage cable or power line.
- If laid in the same conduit or duct, induction noise from them may caused malfunction or breakdown of the product.
- Be sure to turn the power OFF before inserting or removing the I/O terminals. Otherwise it may result in a failure.
- Do not connect ZN-DPX21-S□ to a sensor head other than ZN-DPS1□□-S. Do not conect ZN-THX21-S□ and ZN-THX11-S□ to a sensor head other than ZN-THS1□□-S. Do not hold only the sensor head mounted to the product body.

3. Battery Use

- Do not combine use of new and old batteries, or do not use batteries in combinations with those of different makers or models. Doing so may result in malfunction.
- Do not insert a battery with the polarity inverted.
- Be sure to mount a battery cover during use. Be careful that the operation of the device cannot be guaranteed if a battery is removed because the battery cover is not mounted.
- Remove the batteries if you do not use the product for a long period of time. If leaving the used batteries in the product for a long period of time, corrosion of the device may occur due to a battery leak.
- Do not disassemble or throw the battery into the fire.
- When the battery level is low, a restart may be repeated. If such event occurs, replace the batteries with new ones.
- When using network connection mode, use an AC adapter because the battery becomes exhausted fast. (excluding ZN-THX11-S□)

4. Battery Disposal

- For disposal of batteries after replacement, restrictions may apply depending on the local government. Dispose of the battery according to your local government.

5. Mounting screw holes

- The screw hole is M3 and the depth of the screw is 4 mm. Do not tighten a screw with more than 4 mm in depth. Doing so may damage the product.

6. Seal at the bottom of the main unit

- Never remove the seal at the bottom of ZN-THX11-S□ as there is a connector used for maintenance purpose conducted by OMRON.

7. Long-term storage

- If the product will not be used for a long period of time, store the product in the location where the temperature is not too high. Otherwise the built-in battery may drain faster.

How to Read This Manual

■ Meanings of Symbols

Menu items that are displayed on the screen, and windows, dialog boxes and other GUI elements displayed on the PC are indicated enclosed by brackets "[]".

■ Explanation of Symbols

DPX21: Only ZN-DPX21-S□ is applicable.

THX21: Only ZN-THX21-S□ is applicable.

THX11: Only ZN-THX11-S□ is applicable.

Common: All models are applicable.

Important: Indicates the description of an essential point regarding a function, such as an important point regarding operation or advice on how to use it.

Note: Indicates application procedures.

Table of Contents

Introduction	i
Table of Contents	ix
1. Product Overview	1-1
1.1 Features and Functions	1-1
1.1.1 ZN-DPX21-S	1-1
1.1.2 ZN-THX21-S	1-2
1.1.3 ZN-THX11-S.....	1-3
1.2 Types of Usage	1-4
1.2.1 Standalone	1-4
1.2.2 Network Connection	1-4
1.2.3 Connecting with Air Particle Sensor (ZN-PD□□-S□)	1-5
1.3 Setup and Operation Procedure	1-6
1.3.1 Standalone Operation	1-6
1.3.2 When using the product via network connection	1-7
1.3.3 When using the product with Air Particle Sensor (ZN-PD□□-S□) connected.....	1-8
2. Exterior Features	2-1
2.1 Unit.....	2-1
2.2 Display Unit.....	2-3
2.3 Control Unit	2-4
2.3.1 Control key	2-4
2.3.2 Reset switch.....	2-4
2.3.3 Inserting/removing SD memory card.....	2-4
2.4 Input/Output Specifications	2-6
2.4.1 Alarm output.....	2-6
3. Check and Preparation	3-1
3.1 Checking the Contents.....	3-1
3.2 Preparing Necessary Items.....	3-2
3.3 Assembly.....	3-3
3.3.1 Connecting the unit	3-3
3.3.2 Connecting alarm output terminals.....	3-3

3.3.3	Preparing power supply	3-3
3.3.4	Checking operation	3-5
3.4	PC Software	3-6
3.5	Connecting to Network.....	3-7
3.5.1	Preparation.....	3-7
3.5.2	Setting IP address of the Unit.....	3-8
3.5.3	Setting the PC's IP address	3-11
3.5.4	Connecting LAN cable	3-17
3.6	Mounting the Unit.....	3-18
3.6.1	Free-stand Installation.....	3-18
3.6.2	Securing with mounting screws.....	3-18
3.6.3	Mounting with screw hook hole	3-19
4.	Setting the Unit (Unit Operation)	4-1
4.1	Setting Procedure and Operation Modes	4-1
4.2	Settings in FUN Mode	4-2
4.2.1	List of setting items	4-2
4.2.2	Selecting operation mode "FUN"	4-3
4.2.3	Selecting items.....	4-4
4.2.4	Description of items.....	4-5
4.2.5	Changing the setting value.....	4-11
4.3	Making Settings (Operation in THR Mode).....	4-13
4.3.1	Selecting operation mode	4-13
4.3.2	List of setting items	4-13
4.3.3	Selecting items.....	4-14
4.3.4	Description of items.....	4-14
4.3.5	Changing the setting value.....	4-16
4.4	Making Settings (Operation in SCL Mode)	4-17
4.4.1	Selecting operation mode	4-17
4.4.2	List of setting items	4-17
4.4.3	Selecting items.....	4-18
4.4.4	Description of items.....	4-18
4.4.5	Changing the setting value.....	4-19
4.5	Copying the Settings When Using Multiple Units	4-20
5.	Measurement and Recording (Unit Operation)	5-1
5.1	Overview	5-1

5.2	Selecting Operation Mode	5-2
5.3	Screen Transition in RUN Mode	5-3
5.3.1	ZN-DPX21-S	5-3
5.3.2	ZN-THX21-S / ZN-THX11-S	5-4
5.4	Starting/Stopping Recording	5-5
5.4.1	Starting recording	5-5
5.4.2	Stopping Recording	5-5
5.5	Outputting the File to SD memory card	5-6
5.6	Releasing the Held Alarm	5-7
5.7	Hiding the Display	5-8
6.	Connecting with Air Particle Sensor (ZN-PD□□-S□)	6-1
6.1	Connection setting of the unit	6-1
6.2	Recording	6-2
6.3	Displaying Graph	6-3
7.	Appendix	7-1
7.1	Ratings and Performance	7-1
7.1.1	ZN-DPX21-S	7-1
7.1.2	ZN-THX21-S	7-3
7.1.3	ZN-THX11-S	7-5
7.2	List of Displayed Errors	7-7
7.3	List of Displayed Characters	7-8
7.4	Configuration of SD memory card Folder	7-9
7.5	Calibration	7-10

Revision History

1. Product Overview

1.1 Features and Functions

1.1.1 ZN-DPX21-S

(1) High-precision Differential Pressure Sensor

Differential Pressure Sensor Head ZN-DPS1□□-S allows for the accurate measurement with a range at -500 to 500 Pa and differential pressure accuracy of +/-3 % (zero point accuracy of +/-0.2 Pa). The ZN-DPS1□□-S provides more precise control of the differential pressure, contributing to maintaining clean room environments.

(2) Network connections

By connecting the Differential Pressure Stations to a PC via LAN cable and using the PC software, the measured values obtained from one or more Differential Pressure Stations can be moved to the PC, and the settings of a Differential Pressure Station can be checked or changed and start/stop recording of the Differential Pressure Station can be specified. (Refer to "Multi Data Viewer Light Software Manual" for details.)

Furthermore, use of the optional Wave Inspire ES environmental visualization software allows for real-time centralized control online.

(3) Recording with SD memory card

The measured data can be recorded in the Differential Pressure Station while communicating via LAN with host devices. Up to approximately 11,000 data can be accumulated in the internal memory of the sensors (except for an Air Particle Sensor), and the data recording in the Differential Pressure Station unit can be continued even at an emergency network failure. The data accumulated in the internal memory can be output to the SD memory card as a CSV file without stopping measurement operation, and the data can be managed by a PC.

(4) Graphical display software

The data recorded in a PC with the logging tool and the data output to the SD memory card with the Thermo-Humidity Station can be displayed as graphs by the PC software (offline). The data items of different periods can be combined, the data items of temperature and humidity can be displayed side by side, and the data across multiple Thermo-Humidity Stations can be displayed side by side. (For details, refer to "Multi Data Viewer Light Software Manual".)

(5) Alarm output

The Differential Pressure Station comes standard with the alarm output terminals. The alarm output is activated when the measured differential pressure exceeds upper or lower limit. For example, the Differential Pressure Station can be used for various management systems such as a positive level warning in a clean room, and automatic control of the air conditioning level based on the differential pressure level.

(6) Battery backup

The product has a battery backup function (two AAA batteries). Using rechargeable nickel metal hydride batteries or alkaline batteries prevents failure in communications via LAN and recording operations in case of a power failure or power shutdown.

* The unit can operate up to approximately 2 hours with batteries only. However, the battery life varies subject to measurement environment, conditions, and type or performance of the batteries.

1.1.2 ZN-THX21-S**(1) High-precision Air Thermo Sensor**

Air Thermo Sensor Head ZN-THS1□□-S allows for the accurate measurement of the temperature and humidity with a temperature resolution of 0.1°C (at 25°C) and humidity accuracy of ± 2.5 %RH (25°C, 10 to 85 %RH). The ZN-THS1□□-S contributes to the improvement for better quality and management of temperature and humidity through accurate measurement.

(2) Network connections

By connecting the Thermo-Humidity Stations to a PC via LAN cable and using the PC software Multi Data Viewer Light, the measured values obtained from one or more Thermo-Humidity Stations can be moved to the PC, and the settings of a Thermo-Humidity Station can be checked or changed and start/stop recording of the Thermo-Humidity Station can be specified. (Refer to "Multi Data Viewer Light Software Manual" for details.)

Furthermore, use of the optional Wave Inspire ES environmental visualization software allows for real-time centralized control online.

(3) Recording with SD memory card

The measured data can be recorded in the Thermo-Humidity Station while communicating via LAN with host devices. Up to approximately 8500 data items can be accumulated in the internal memory of the sensors (except for an Air Particle Sensor), and the data recording in the Thermo-Humidity Station unit can be continued even at an emergency network failure. The data accumulated in the internal memory can be output to the SD memory card as a CSV file without stopping measurement and the data can be managed by a PC.

(4) Graphical display software

The data recorded in a PC with the logging tool and the data output to the SD memory card with the Thermo-Humidity Station can be displayed as graphs by the PC software (offline). The data items of different periods can be combined, the data items of temperature and humidity can be displayed side by side, and the data across multiple Thermo-Humidity Stations can be displayed side by side. (Refer to "Multi Data Viewer Light Software Manual" for details.)

(5) Alarm output

The Thermo-Humidity Station comes standard with the alarm output terminals. The alarm will output when measured temperature or humidity exceeds upper or lower limit. This function allows quick response to the problem by visualizing the limit of temperature and humidity.

(6) Battery backup

This product has a battery backup function (two AAA batteries). Using rechargeable nickel metal hydride batteries or alkaline batteries prevents failure in communications via LAN and recording operations in case of a power failure or power shutdown.

* This product can operate up to approximately 2 hours with batteries only. However, the battery life varies subject to measurement environment, conditions, and type or performance of the batteries.

1.1.3 ZN-THX11-S

(1) High-precision Air Thermo Sensor

Air Thermo Sensor Head ZN-THS1□□-S allows for the accurate measurement of the temperature and humidity with a temperature resolution of 0.1 °C (at 25 °C) and humidity accuracy of ± 2.5 %RH (25 °C, 10 to 85 %RH). The ZN-THS1□□-S contributes to the improvement for better quality and management of temperature and humidity through accurate measurement.

(2) Recording with SD memory card

The measurement data is accumulated in the internal memory and output as a CSV file to an SD memory card by pressing the SET/REC/STOP key.

The internal memory can accumulate approximately 8,500 data, output them to an SD memory card without stopping measurement and collect the data when required

In the SD memory card, the measured data is saved in the folder having a unique name to identify the Air Thermo Logger. Therefore, even if two or more Air Thermo Loggers are controlled, the data of each logger can be collected with one SD memory card while the data in each logger is normally saved in each internal memory.

Approximately 17 million data items can be recorded (can be stored for 5 years with one Air Thermo Logger with a measurement interval of 10 seconds).

(3) Graphical display software

The data output to the SD memory card can be displayed as graphs with PC software. The graphs can be displayed by just specifying the SD memory card drive on the PC. The data items of different periods can be connected, and the data items collected from one or more Air Thermo Logger can be displayed side by side.

For details, refer to "Multi Data Viewer Light Software Manual".

(4) Alarm output

The main unit of the Air Thermo Logger has the alarm output terminals. The alarm will output when the measured differential pressure exceeds upper or lower limit. This function allows you to quickly handle problems by visualizing the limit of temperature and humidity.

(5) Battery drive

Other than supplying power from the outside, the product can be operated with batteries (two AAA batteries). The battery drive can last approximately 1 year under the condition with a measurement interval of 10 minutes, sleep mode and the use of rechargeable nickel metal hydride batteries. The internal memory is always backed up so that it will not be deleted after running out of batteries.

* The battery life varies according to measurement environment, conditions, and type or performance of the batteries.

1.2 Types of Usage

There are three types to use this product as follows:

1.2.1 Standalone

The unit can be used alone without connecting to a network. The measured data is recorded in the internal memory and can be moved to a PC through an SD memory card. The recorded data in the SD memory card can be displayed as graphs using the PC software.



Standalone

1.2.2 Network Connection DPX21 THX21

The unit can be connected with a PC via LAN (Ethernet). The supplied PC software provides the following operations: (Refer to "Multi Data Viewer Light Software Manual" for the details of the PC software.)

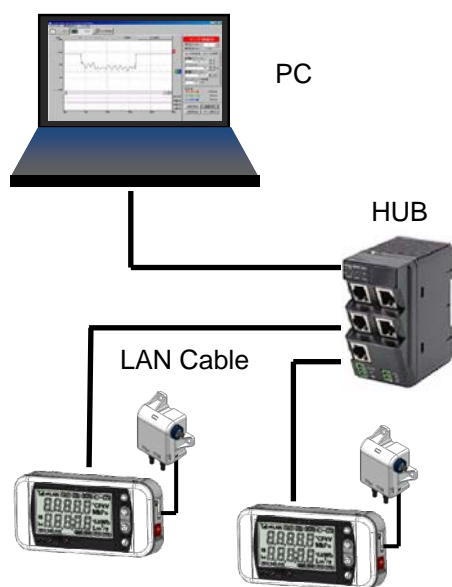

Network Connection

(1) Remote settings and operation with the PC

Remote settings (except for IP address settings and measured value adjustment settings) of the unit and remote operation such as starting/stopping recording can be performed.

(2) Recording the measured data to a PC

By using the logging tool of the PC software, the measured data recorded in the unit can be moved into the PC. The recorded measured data in the PC can be displayed as graphs using the PC software.

Important

- When connecting a unit with a PC, the unit cannot be connected to an Air Particle Sensor (ZN-PD□□-S□) to display or record the measured data.

1.2.3 Connecting with Air Particle Sensor (ZN-PD□□-S□) DPX21 THX21

One Air Particle Sensor ZN-PD□□-S□ can be connected to the unit with LAN cables. The data measured with the Air Particle Sensor (ZN-PD□□-S□) can be recorded in the internal memory of the unit. The data recorded in the internal memory can be displayed as graphs via the SD memory card using the PC software.



Connecting with Air Particle
Sensor (ZN-PD□□-S□)

Note

- When an Air Particle Sensor (ZN-PD□□-S□) is connected with the unit, the measured data cannot be moved into the PC using the PC software.
- The optional Wave Inspire ES environmental visualization software can record and monitor the measured data with the network-connected Air Particle Sensor (ZN-PD□□-S□) on the PC.

1.3 Setup and Operation Procedure

1.3.1 Standalone Operation

Check the contents.

→ 3.1 Checking the Contents

Check the necessary items.

→ 3.2 Preparing Necessary Items

Connect Sensor Head and alarm output terminals, prepare power supply

→ 3.3 Assembly

Install the Multi Data Viewer Light PC software

→ "Multi Data Viewer Light Software Manual" 1.5 Installation

Make settings by operating the main unit.

→ 4 Setting the Unit (Unit Operation)

Record data into the main unit by operating itself.

→ 5 Measurement and Recording (Unit Operation)

Analyze short-period recording data

→ "Multi Data Viewer Light Software Manual" 4.4 Graph Display

Analyze long-period recording data

→ "Multi Data Viewer Light Software Manual" 3.7 Displaying Graphs

1.3.2 When using the product via network connection **DPX21** **THX21**

Check the contents.

→ 3.1 Checking the Contents

Check the necessary items.

→ 3.2 Preparing Necessary Items

Connect Sensor Head and alarm output terminals, prepare power supply

→ 3.3 Assembly

Install the Multi Data Viewer Light PC software

→ "Multi Data Viewer Light Software Manual" 1.5 Installation

Connect to a network

→ 3.5 Connecting to Network

Record data to PC

→ "Multi Data Viewer Light Software Manual" 2.6 Creating/Saving Projects

Remotely record data to the unit

→ "Multi Data Viewer Light Software Manual" 2.8 Logging

Analyze short-period recording data

→ "Multi Data Viewer Light Software Manual" 4.4 Graph Display

Analyze long-period recording data

→ "Multi Data Viewer Light Software Manual" 3.7 Displaying Graphs

1.3.3 When using the product with Air Particle Sensor (ZN-PD□□-S□) connected

DPX21 THX21

Check the contents.

→ 3.1 Checking the Contents

Check the necessary items.

→ 3.2 Preparing Necessary Items

Connect Sensor Head and alarm output terminals, prepare power supply

→ 3.3 Assembly

Install the Multi Data Viewer Light PC software

→ "Multi Data Viewer Light Software Manual" 1.5 Installation

Connect to Air Particle Sensor (ZN-PD□□-S□).

→ 6 Connecting with Air Particle Sensor (ZN-PD□□-S□)

Make settings by operating the main unit.

→ 4 Setting the Unit (Unit Operation)

Record data in the main unit by operating itself.

→ 5 Measurement and Recording (Unit Operation)

Analyze short-period recording data

→ "Multi Data Viewer Light Software Manual" 4.4 Graph Display

Analyze long-period recording data

→ "Multi Data Viewer Light Software Manual" 3.7 Displaying Graphs

2. Exterior Features

2.1 Unit

DPX21 THX21

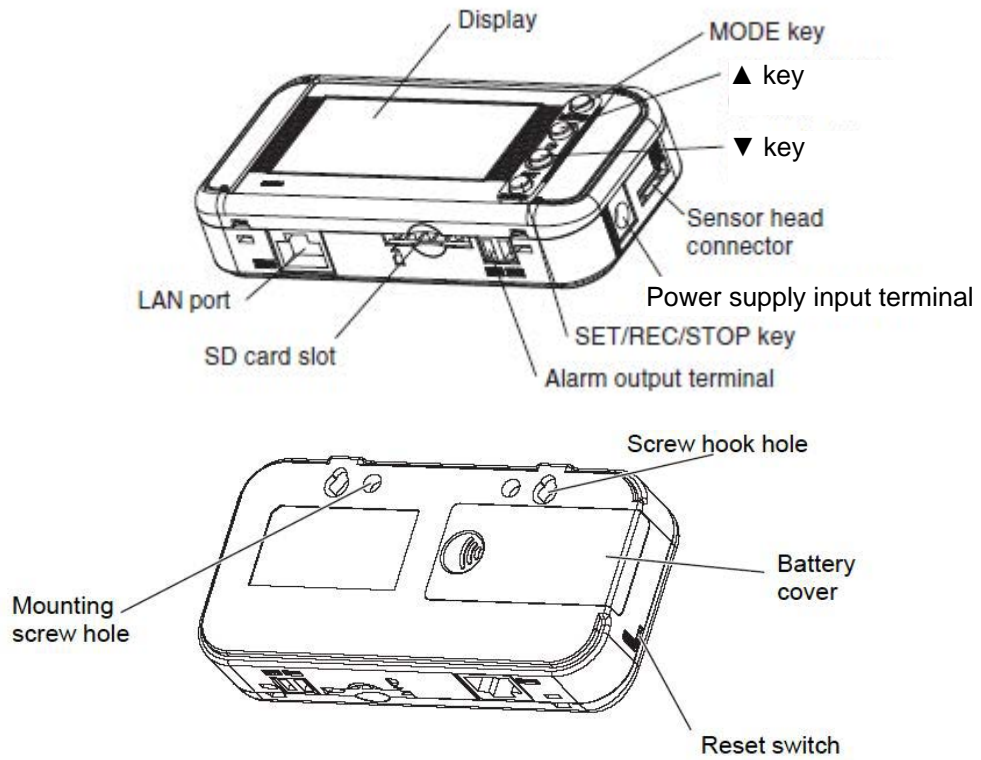

THX11

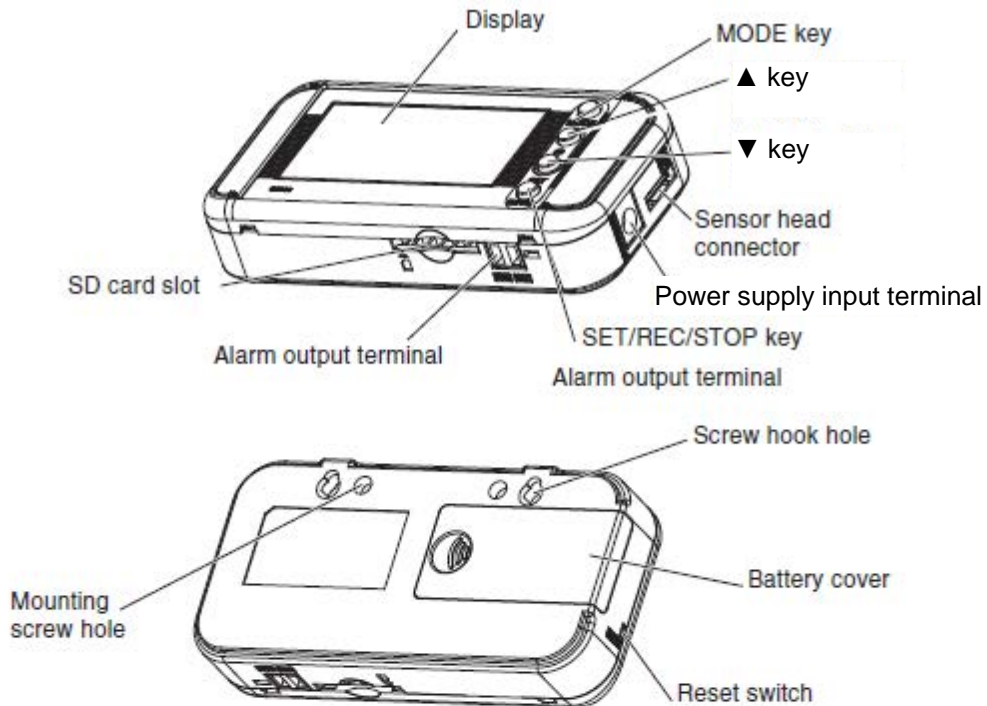

Name	Function
MODE key	Switches operating modes
	Releases error and alarm (holding)
	Cancels during settings
Item select key (△ key)	Moves setting items (upper direction)
	Switches display screens (reverse direction)
	Changes the setting value (increasing)
Item select key (▽ key)	Moves the setting items (lower direction)
	Switches the display screens (forward direction)
	Changes the setting value (decreasing)
SET/REC/STOP key	Confirms the setting value
	Starts/stops record (holding)
	Saves recorded data to the SD memory card.
Mounting screw hole	Used to secure screws (M3x4 mm female hole)
Screw hook hole	For screw head hook
Battery cover	Battery chamber cover
Reset switch	Restarts the unit.*

* Used when an SD card is not available when recording stops, or when error recovery cannot be made.

2.2 Display Unit

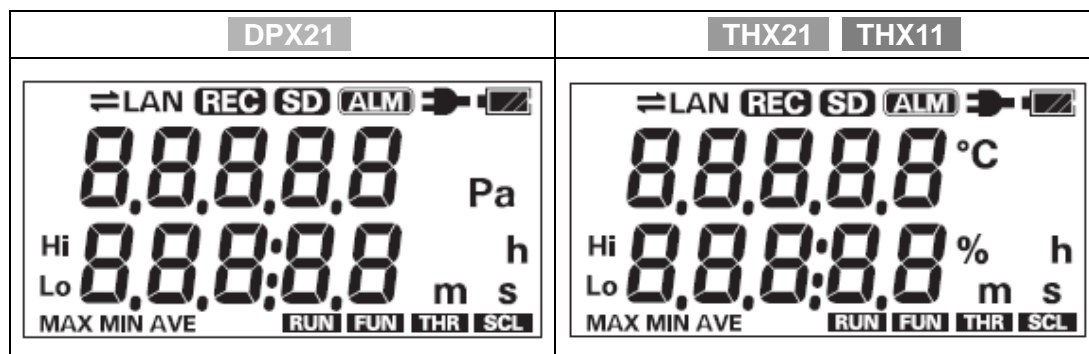

Meanings of indicators

Display	Meaning and operation when turned on
*1	Communicating with the LAN cable.
LAN *1	The LAN cable is connected. Ready for network communication.
REC	Recording data in the internal memory.
SD	SD memory card has been inserted. SD is being accessed while light blinking.
ALM	The measured value exceeds the set threshold value.
	The power is supplied by the AC adaptor or the DC power supply.
	The battery level is displayed in 4 levels. Replace batteries when it blinks
Hi	Upper limit threshold
Lo	Lower limit threshold
MAX	The measurement is processed to extract Max. value.
MIN	The measurement is processed to extract Min. value.
AVE	The measurement is processed to extract Ave. value.
RUN	Current operating mode is set to RUN mode.
FUN	Current operating mode is set to FUN mode.
THR	Current operating mode is set to THR mode.
SCL	Adjusting the measured values when it is turned on with RUN on. Current operating mode is SCL when only SCL is turned on.

*1: The indicators and **LAN** are not displayed on ZN-THX11-S□.

For alphabets, numerals and major displayed images on the display screen, refer to the Appendix.

Refer to: List of Displayed Characters in Appendix.

2.3 Control Unit

2.3.1 Control key

Name	Main functions
MODE key	Switch operating modes. Release an alarm or an error (press and hold). Cancel settings before fixing.
Item selection key (▲ key)	Move up the setting items. Change display screens. Change setting values (increasing).
Item selection key (▼ key)	Move down the setting items. Change display screens. Change setting values (decreasing).
SET/REC/STOP key	Fix setting values etc. Start/stop record (press and hold). Send the recorded data into the SD memory card.

2.3.2 Reset switch

There is a reset switch at the back of the hole located at the left side of the main unit.

The unit will restart by pressing the reset switch with a thin wire, etc.

When the unit restarts, do not touch the front key until the differential pressure, temperature or humidity is displayed.

Settings are not initialized by the reset.

2.3.3 Inserting/removing SD memory card

This product has an SD card slot to output CSV files or write the measured data recorded in the internal memory, and to write/read the setting data.

Important

- When inserting/removing the SD memory card, make sure to hold the main unit firmly. When the product is mounted with its screw hook hole, inserting/removing the SD memory card without firmly holding the main unit may result in dropping and damaging the SD memory card.
- When "SD" on the display is blinking, do not remove the SD memory card. Doing so may destroy the data in the SD memory card.
- Do not touch the metal terminal of the SD memory card.
- Do not bend the SD memory card.
- When inserting/removing the SD memory card, be aware of static electricity.
- Do not enable the write-protection of the SD memory card.

(1) Inserting SD memory card

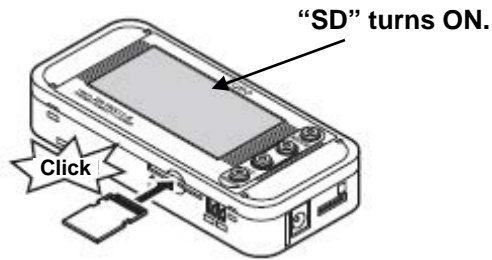

- [1] Insert the SD memory card into SD card slot with the metal terminal face up.
- [2] Insert the SD memory card until it clicks.
- [3] "SD" will be displayed on the display.

(2) Removing SD memory card

- [1] Push the inserted SD memory card as far as possible until it clicks.
- [2] When you take off your hand from the card, it will come out. Be careful not to drop it.
- [3] "SD" on the display disappears.

Important

- If the SD memory card has not been formatted yet, format it before inserting into the SD card slot.
- For the page to download the formatting software for SD memory cards, refer to the following URL.
<https://www.sdcard.org/downloads/formatter/>

2.4 Input/Output Specifications

2.4.1 Alarm output

(1) Alarm output terminals

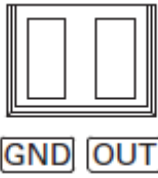

[1] OUT

Outputs the judgment result allocated in THR mode.

[2] GND

It is a common terminal.

Terminal names are inscribed on the unit.

The attached alarm output connector is used for wiring.

(2) Output specifications

External power supply voltage	12 to 24 VDC $\pm 10\%$
Load current	45 mA max.
ON residual voltage	1.2 V max.
OFF leakage current	0.1 mA max.
Internal circuit diagram	

Important

- Do not directly connect the external power supply between OUT and GND. Be sure to connect the load.

3. Check and Preparation

3.1 Checking the Contents

This product includes the following items:

- Main Unit ZN-DPX21-S□, ZN-THX21-S□ or ZN-THX11-S□ 1
- AC adapter or DC power supply cable 1
- Alarm Output Connector 1
- Instruction Sheet 1
- Startup Guide 1

3.2 Preparing Necessary Items

The following items are required to use this product.

(1) Standalone

DPX21

- Differential Pressure Sensor Head ZN-DPS1□□-S 1 (Sold separately)

THX21

THX11

- Thermo-Humidity Sensor Head ZN-THS1□□-S 1 (Sold separately)

Common

- SD memory card (SDHC compatible) 1
For saving and moving measured data (When recording data with the Station unit)
Recommended: HMC-SD292 (2 GB), HMC-SD492 (4GB)
- AAA Batteries (for battery operation) 2
Alkaline batteries or rechargeable nickel hydrogen (Ni-MH) batteries
- PC for the PC Software 1

Important

- Manganese batteries cannot be used.
- Use two batteries of the same type. Do not mix the old and new batteries.

(2) Connecting to a network **DPX21** **THX21**

Following items are required in addition to the necessary items for standalone units.

- LAN Cable (10BASE-T or 100BASE-TX supported, Safety Category 5e or higher, straight)
- HUB for LAN connection (10BASE-T or 100BASE-TX supported)

Important

- When connecting the product with a PC via network connection or connecting it with an Air Particle Sensor (ZN-PD□□-S□), the battery life is approximately 2 hours (for 10-minute measurement intervals and using nickel metal hydride batteries). Supply the power with the AC adaptor or the DC power supply.

Note

- When connecting a unit to a PC, use a hub.

(3) Connecting to Air Particle Sensor (ZN-PD□□-S□) **DPX21** **THX21**

Following items are required in addition to the necessary items for standalone units.

- Air Particle Sensor ZN-PD□□-S□ 1
- LAN Cable (10BASE-T or 100BASE-TX supported, Safety Category 5e or higher)

Note

- Before setting the Air Particle Sensor (ZN-PD□□-S□), read the Instruction Sheet attached to the product.
- Use LAN cable to connect the unit and Air Particle Sensor (ZN-PD□□-S□). In this case, either straight or cross cable usable.

3.3 Assembly

3.3.1 Connecting the unit

Before using this product, be sure to check the combination of the sensor head that can be connected to the unit.

Unit name	Sensor head name
ZN-DPX21-S□	Differential Pressure Sensor Head ZN-DPS1□□-S
ZN-THX21-S□	Air Thermo Sensor Head ZN-THS1□□-S
ZN-THX11-S□	

Insert the Sensor Head into the Sensor Head connector until it clicks.



3.3.2 Connecting alarm output terminals

Use the attached alarm output connector to connect OUT and GND to the loads according to the output specifications.

Refer to : 2.4.1 Alarm output

3.3.3 Preparing power supply

This product can be driven by supplying power or by batteries

(1) When supplying power

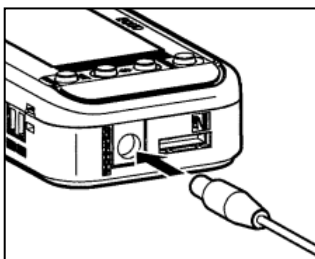

- (1) Insert the plug of the AC adapter or DC power supply cable into the power supply input terminal.

- (2) When using an AC adapter, insert the plug of the AC adapter into an outlet. (100 VAC to 240 VAC).

When using a DC power supply cable, connect the wire with white line on it to the power(24 VDC±10 %), and connect the other wire to 0V.

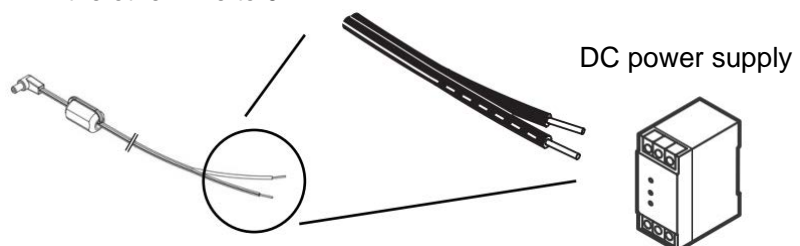
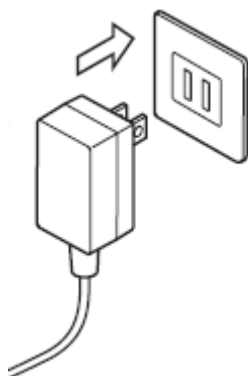

Important

- When using an AC power supply, use the attached AC adapter.
- When using a DC power supply, use the attached DC cable.
- When the product to connect via network or connect with an Air Particle Sensor (ZN-PD□□-S□), Supply the power with the AC adaptor or DC power supply.

Note

- The main unit does not have a power supply button. When supplying the power to the product, the Air Thermo Station starts operation immediately.
- AC adaptor/DC power supply has priority when connecting AC adaptor or DC power supply as using a battery in the product. When supplying power has stopped due to a power failure, it will be automatically switched to battery power if mounted.

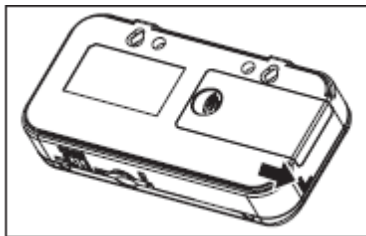
(2) When using batteries

[1] Slide to open the battery cover on back of the main unit.

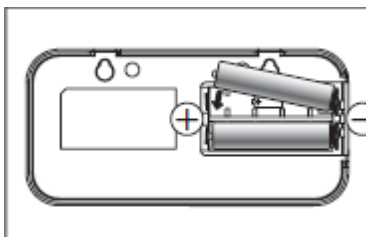

[2] Insert two batteries with careful attention to proper polarity.

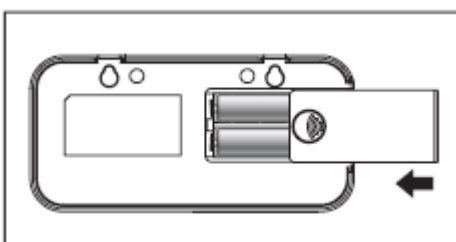

[3] Slide to close the battery cover.

Important

- When inserting the batteries, be careful about the direction of the polarity. Inserting the battery with wrong polarity may result in damage of the main unit.
- Use two batteries of the same type. Do not mix the old and new batteries.
- When using the product via network connection or connecting it with an Air Particle Sensor (ZN-PD□□-S□), the battery life is approximately 2 hours (for 10-minute measurement intervals and using nickel metal hydride batteries). Supply the power with the AC adaptor or the DC power supply.

Note

- When driving the product with batteries without connecting to a network, it is recommended to operate the product in sleep mode. In sleep mode, the Differential Pressure Station cannot be connected to a network and Air Particle Sensor (ZN-PD□□-S□).
- Charge the batteries before use. The main unit does not have a function to charge batteries.

3.3.4 Checking operation

When turning ON the power supply, the model name and version are displayed for a while, and then the differential pressure is displayed.

Pressing the ▼ or ▲ key switches the display while “RUN” is ON at the bottom of the display.

Refer to: 5.3 Screen Transition in RUN Mode

Important

- Do not touch any front keys after switching the power supply ON until differential pressure or temperature and humidity are displayed.

3.4 PC Software

For ZN-DPX21-S□, ZN-THX21-S□ and ZN-THX11-S□ the PC software Multi Data Viewer Light can be used. The PC Software Multi Data Viewer Light is a useful tool package for ZN-DPX21-S□, ZN-THX21-S□ and ZN-THX11-S□ settings, logging, as well as data summation and display. The Utility comprises the following three tools:

(1) Summary/Display Tool: Multi Data Viewer

The Multi Data Viewer is the tool used to aggregate, display and analyze measurement data by the Setting Manager and measurement data of the SD memory card recorded by the devices.

(2) Setting/Logging Tool: Setting Manager

The Setting Manager is the tool to make settings on devices and their measurement channels. It can also communicate with the devices to directly collect the measured data for logging.

(3) Instant Value Displaying Tool: SD Viewer ES

The SD Viewer ES provides the graph displays of the data acquired to the PC using the Setting Manager or data recorded to the SD memory card.

For installation and usage, refer to “Multi Data Viewer Light Software Manual.”

3.5 Connecting to Network DPX21 THX21

When connecting the unit to a network, set up network connection to the main unit.
Connect the LAN cable after making the network settings of the main unit.

Important

- Before connecting the product to a network, a full understanding of LAN is necessary.
- When connecting the unit via network, establish a dedicated LAN.
- When the unit is connected to an in-house network or LAN that has been already operated, the number of available IP addresses may be limited and there may be some rules to be followed. Contact network administrator. In such a case, operation of the unit or PC software is not guaranteed.
- Even when using the default IP address and subnet mask, set the measurement operation mode (MODE) to "NET". It will be not connected to network in "SLEEP" or "PD-S" mode.

3.5.1 Preparation

Before establishing network connection, define IP address and subnet mask to be used.

Setting example

IP address of Air Thermo Station	(First unit) 192.168.0.20 (factory default) (Second unit) 192.168.0.21
IP address of PC	192.168.0.100
Subnet mask	255.255.255.0 (factory default)

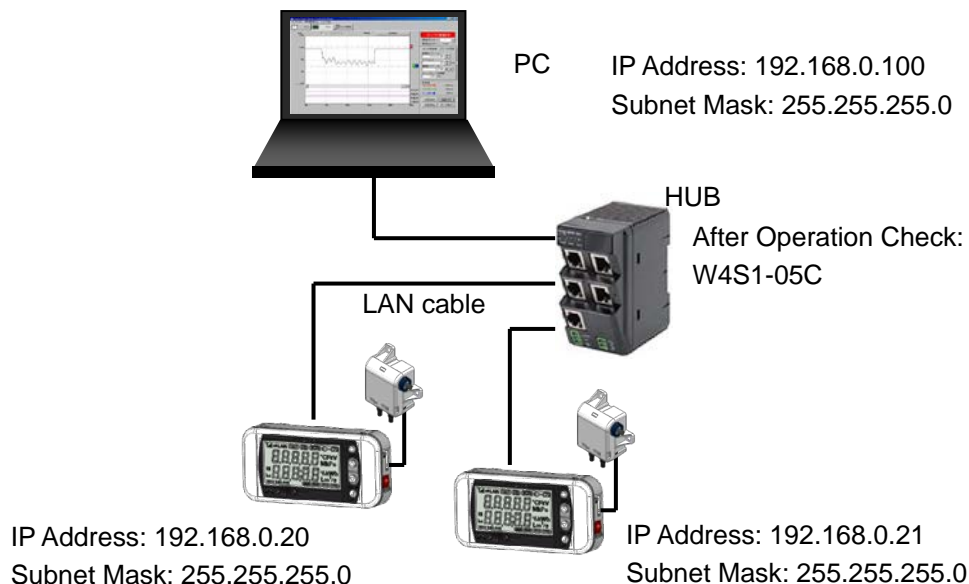

Note

- The factory default IP address for the unit is 192.168.0.20 and subnet mask is 255.255.255.0.
- When connecting the unit and PC to a network, IP address should not be overlapped with other networked devices. In the example above, the IP address of the second unit is set as 192.168.0.21, while the address of the PC is set as 192.168.0.100. The fourth segment value has been changed to distinguish between the devices.

- Set the same values of subnet mask to the unit and PC that will be connected to a network.
- When changing the subnet mask, contact the network administrator. Even when changing the subnet mask from 255.255.255.0, set different values to the fourth segments of IP addresses of the unit and PC to be connected should be set different values.
- Setting range of each segment of IP address and subnet mask is 0 to 255.

3.5.2 Setting IP address of the Unit

For the second unit, the setting procedure of IP address is described below. (Example: changing from 192.168.0.20 (factory default) to 192.168.0.21)

Note

- For details of the meanings of the messages shown on the display and on the functions of operation keys, refer to the following sections.

Refer to: 2.2 Display Unit, 2.3 Control Unit

(1) Setting operation mode to “FUN”

To change the IP address, press MODE key until “FUN” at the right bottom of the display starts blinking.

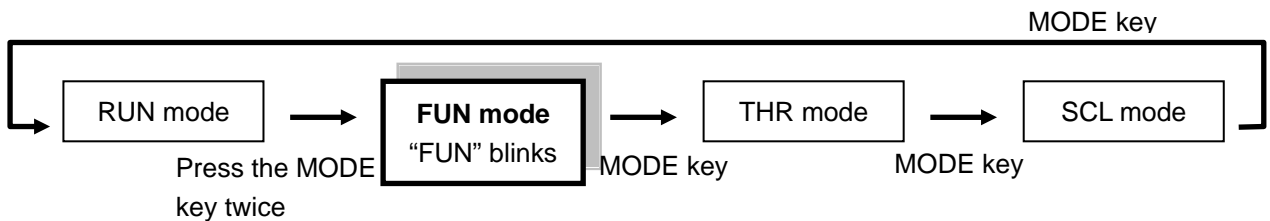

(2) Setting measurement operation mode to “NET”

Display (upper line/ lower line)	Operation
CYCLE 10 s ("FUN" blinks)	Press the ▼ or ▲ key until MODE is displayed in the upper section of the display.
↓ ▼ or ▲ key	
MODE NET	If "NET" is displayed in the lower section, measurement operation mode is set to "NET". Setting of measurement operation mode is complete. When SLEEP or PD-S is displayed, press the SET/REC/STOP key. The lower section starts blinking.
↓ SET/REC/STOP key	
MODE SLEEP ↑ blinks	Press the ▼ or ▲ key to display "NET" in the lower section.
↓ ▼ or ▲ key	
MODE NET ↑ blinks	Press the SET/REC/STOP key to fix the measurement operation mode to "NET". The lower section stops blinking.
↓ SET/REC/STOP key	
MODE NET	

(3) Setting ETC and IP to “DISP”

Display (upper line/ lower line)	Operation
MODE NET ("FUN" blinks)	Press the ▼ or ▲ key until ETC is displayed on the upper section of the display.
↓ ▼ or ▲ key	
ETC OFF	When pressing the SET/REC/STOP key, "OFF" in the lower section blinks.
↓ SET/REC/STOP key	
ETC OFF ↑ blinks	Press t the ▼ or ▲ key to display DISP.
↓ ▼ or ▲ key	
ETC DISP ↑ blinks	Press the SET/REC/STOP key to confirm DISP. Blinking stops.
↓ SET/REC/STOP key	
ETC DISP	Press the ▼ or ▲ key to display IP on the upper section.
↓ ▼ or ▲ key	
IP OFF	Press the SET/REC/STOP key to blink OFF at the lower section.
↓ SET/REC/STOP key	
IP OFF ↑ blinks	Press the ▼ or ▲ key to display DISP.
↓ ▼ or ▲ key	
IP DISP ↑ blinks	Press the SET/REC/STOP key to confirm DISP. Blinking stops.
↓ SET/REC/STOP key	
IP DISP	Continue to IP address settings.

(4) Changing IP address (from factory default 192.168.0.20 to 192.168.0.21)

Display (upper line/ lower line)	Operation
IP DISP	Display the first segment of IP address. Press the ▼ or ▲ key until "IP 1" is displayed in the upper section.
↓ ▼ or ▲ key	
IP 1 192	Check that "192" is displayed in the lower section and then press the ▼ key. If "192" is not displayed, change the value referring to the example of changing "IP 4" as described later.
↓ ▼ key	
IP 2 168	Check that "168" is displayed in the lower section and then press the ▼ key. If "168" is not displayed, change the value referring to the example of changing "IP 4" as described later.
↓ ▼ key	
IP 3 0	Check that "0" is displayed in the lower section and then press the ▼ key. If "0" is not displayed, change the value referring to the example of changing "IP 4" as described later.
↓ ▼ key	
IP 4 20	To change the value at the lower section to 21 that is different from the displayed value, press the SET/REC/STOP key.
↓ SET/REC/STOP key	
IP 4 020 ↑ blinks	The numeric value blinks. Press the ▼ or ▲ key to set the value to 21.
↓ ▼ or ▲ key	
IP 4 021 ↑ blinks	Press the SET/REC/STOP key to confirm the value. Blinking stops.
↓ SET/REC/STOP key	
IP 4 21	To further check and change subnet mask, press the ▼ key to display "SUB1" in the upper section.

↓ ▼ key

Similarly, check that SUB1 to SUB4 are 255, 255, 255 and 0 respectively, and set them. After completion of setting SUB1 to SUB4, press the MODE key. "RESET" is displayed and the system is restarted.

3.5.3 Setting the PC's IP address

This section describes how to set an IP address of the PC to 192.168.0.100.

To set an IP address of the PC, log in with a user account with administrator/manager authority.

(1) Windows 10

Follow the procedure below to set the IP address.

[1] Select "Start menu" – "Control Panel" and then click "Network and Internet".

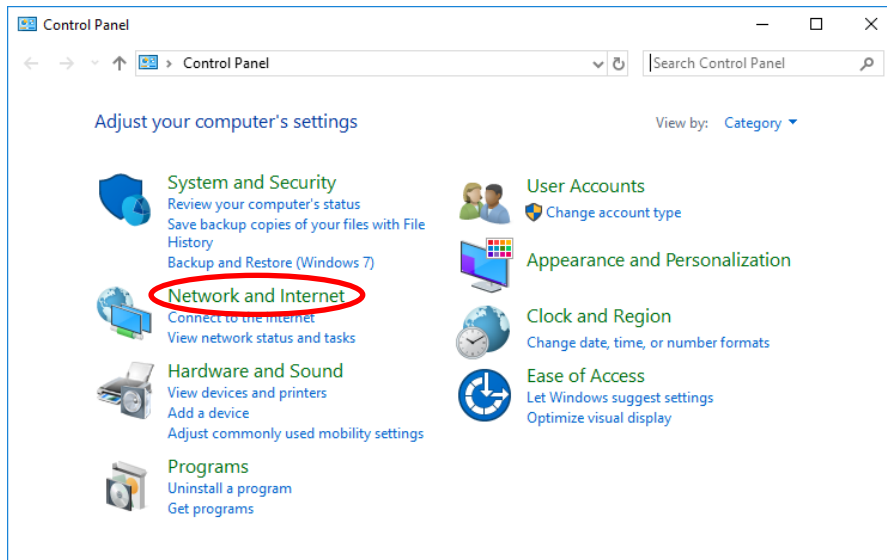

[2] Click "Network and Sharing Center".

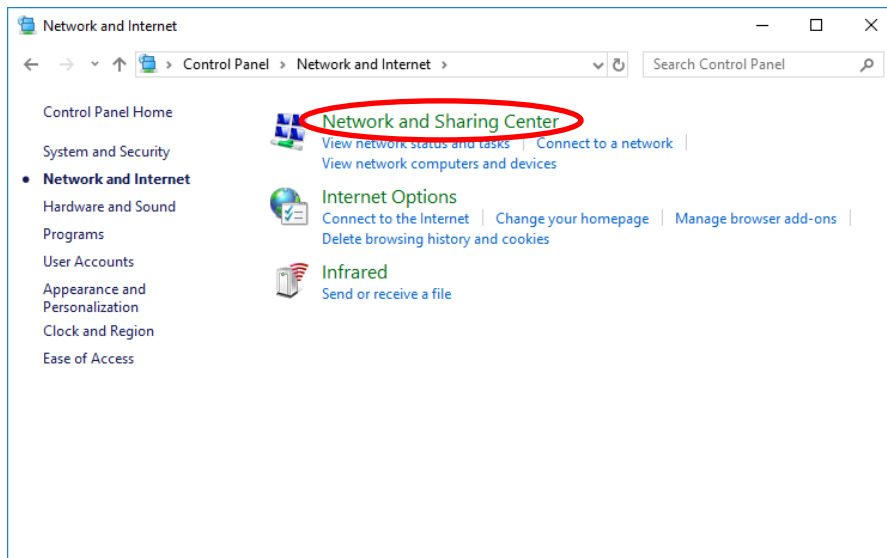

[3] Click “Change adapter settings”.

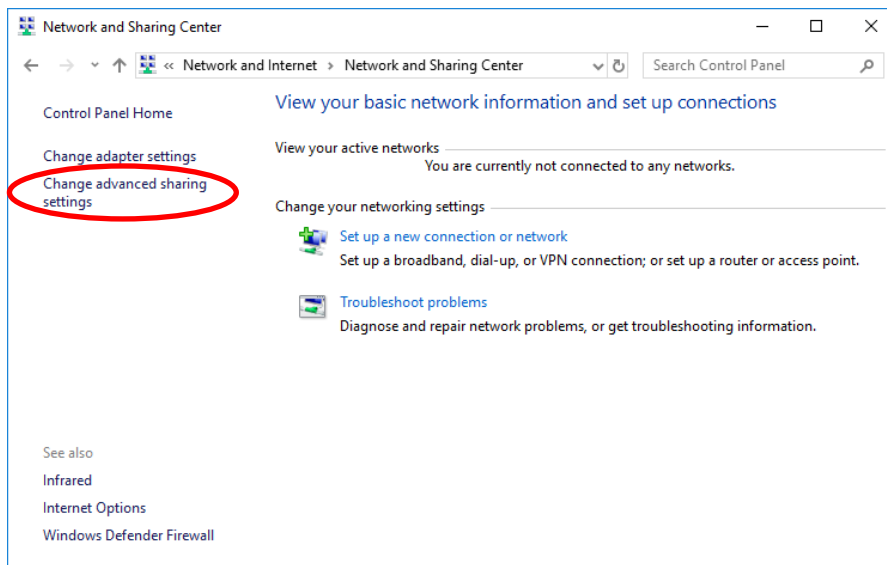

[4] Right-click the network adapter for Internet connection, and select “Properties” on the displayed menu.

As an example, right-click the “Ethernet” icon here.

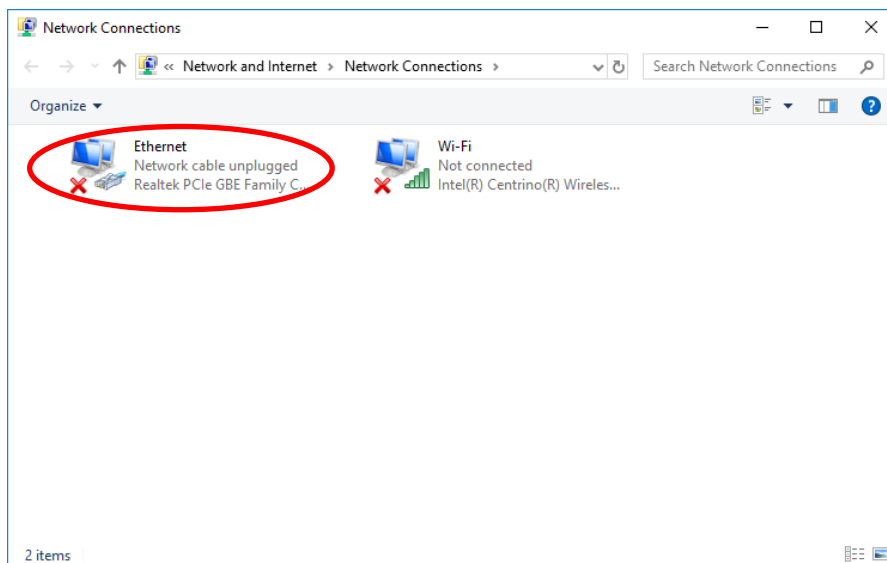

[5] Select "Internet Protocol Version 4 (TCP/IPv4)" and click "Properties".

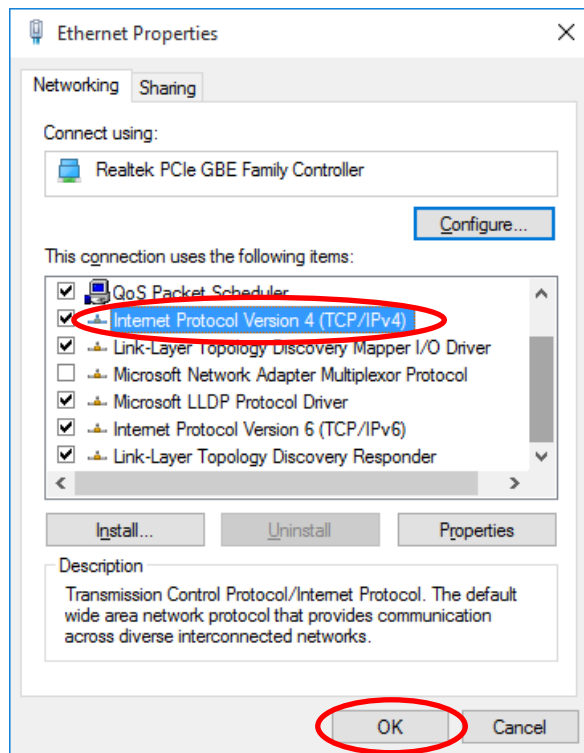

[6] Select "Use the following IP address" and set "IP address" and "Subnet mask". Click "OK" to close the window.

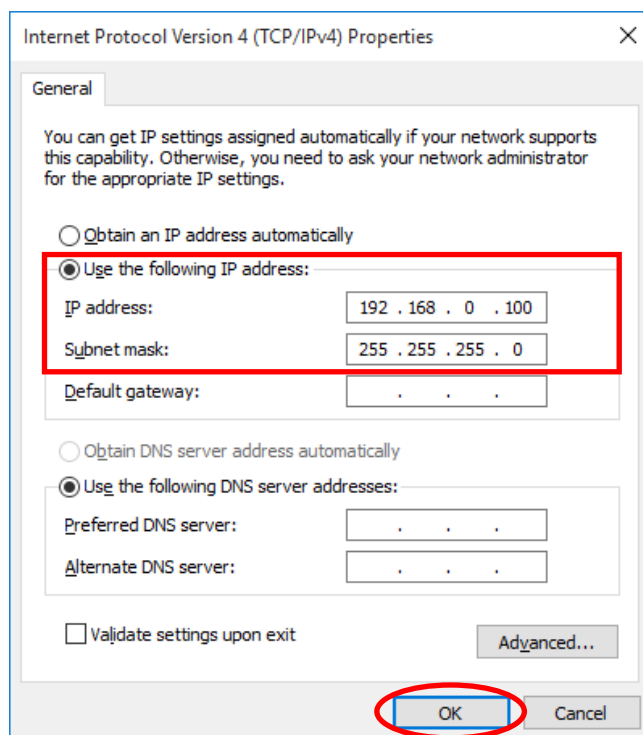

[7] On "Local Area Connections Properties", click "Close" to close the window.

(2) Windows 11

Follow the procedure below to set the IP address.

[1] Select “Start menu” – “Settings” and then click “Network and Internet”.

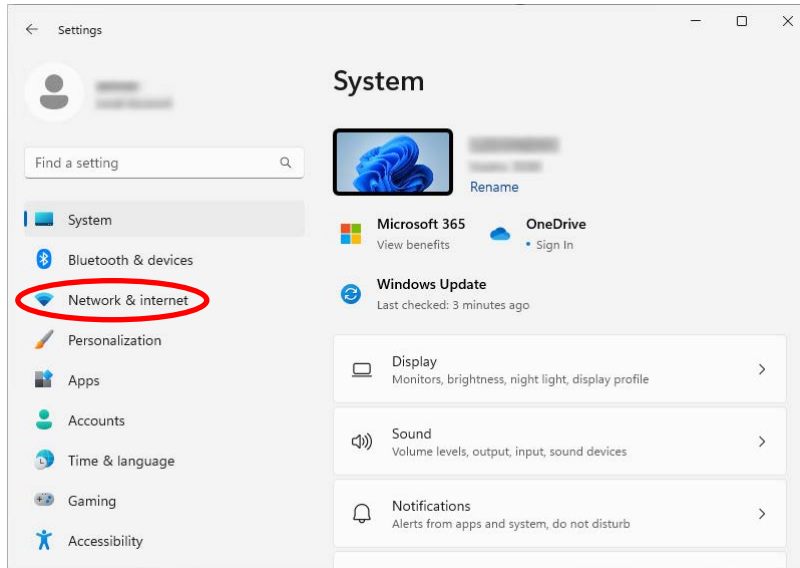

[2] Click “Advanced network settings”.

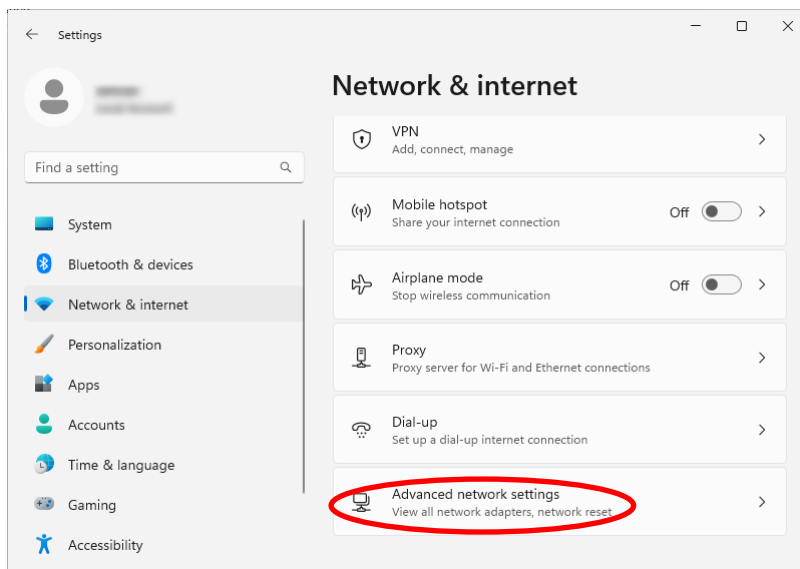

[3] Click “More network adapter options”.

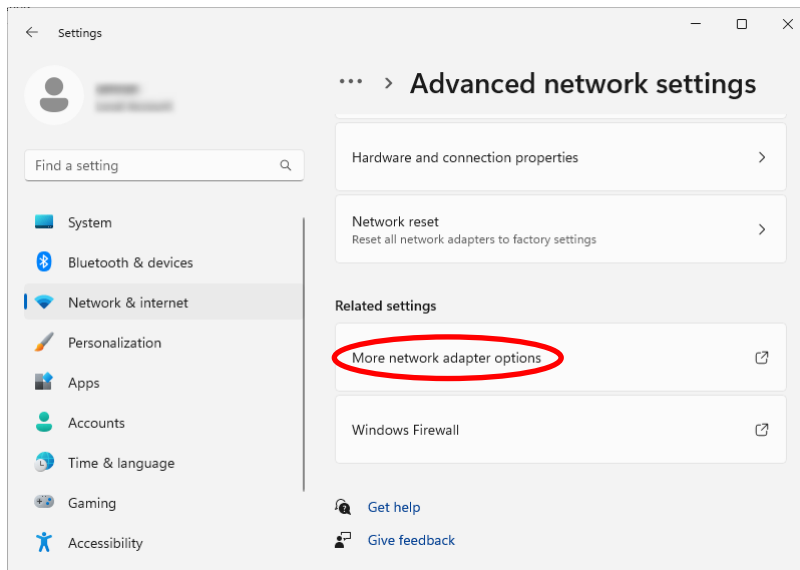

[4] Right-click the “Ethernet” icon, and select “Properties” on the displayed menu.

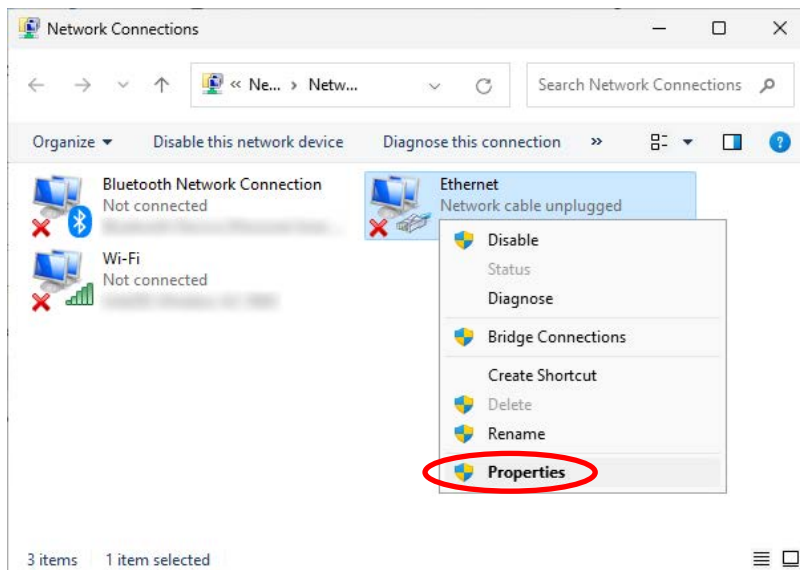

[5] Select "Internet Protocol Version 4 (TCP/IPv4)" and click "Properties".

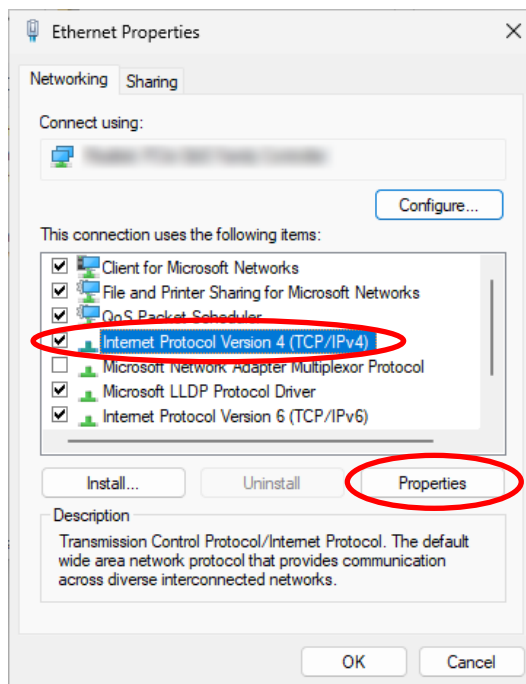

[6] Select "Use the following IP address" and set "IP address" and "Subnet mask". Click "OK" to close the window.

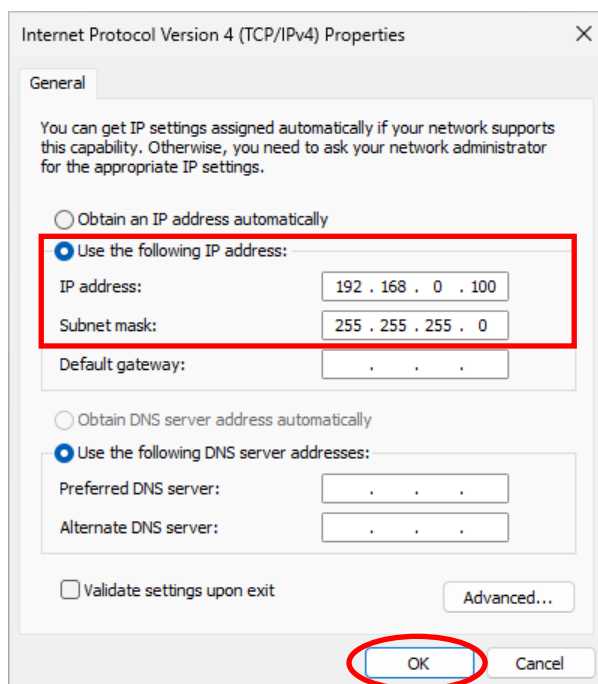

[7] On "Ethernet Properties", click "Close" to close the window.

3.5.4 Connecting LAN cable

Connect LAN cable to the Differential Pressure Station and PC.

When the LAN cable is connected properly, "LAN" is shown on the display.

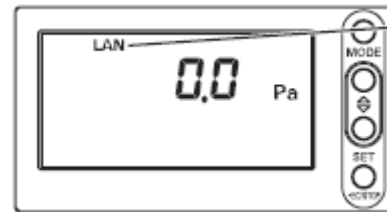
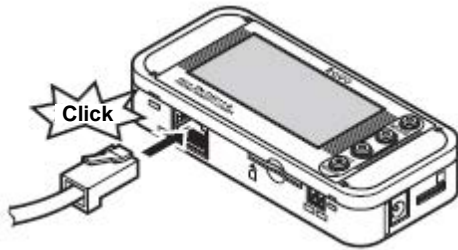

3.6 Mounting the Unit

This section describes the procedure to install the product.

Important

- This product is a sensitive device. Take caution not to let it drop when installing.
- Use screws to fix the product through the provided mounting screw holes for installation on the wall or other equipment where vibration or shock may directly affect the unit.

3.6.1 Free-stand Installation

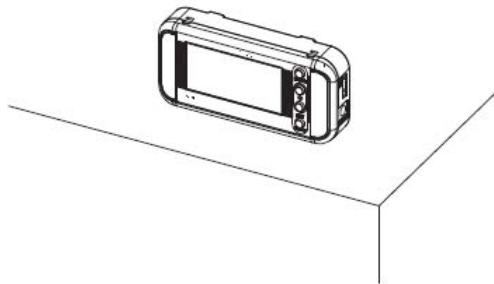

Important

- When placing the product on a desk or other elevated object, place it at a sufficient distance from the edges or corners of the object to prevent the unit from dropping to be damaged.
- Be careful with handling of the power cable, sensor head and LAN cable to prevent them from being hooked.

3.6.2 Securing with mounting screws

There are mounting screw holes at the back of the unit. The unit can be secured on the wall or other surface.

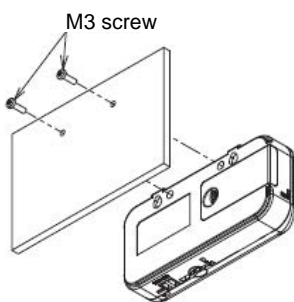

The dimensions to process the screw holes are as follows.

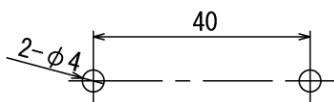

Important

- The depth of the screw hole is 4 mm. Do not tighten screws more than 4 millimeters. It will cause the damage to the product.

Note

- The product can be secured by mounting a magnet for ZN9-EM01-S (sold separately) to the screw hole. (Tightening torque: 0.4 N/cm to 0.6 N/cm)
- When mounting the product with magnet, place it where a mechanical shock is not applied.
- When the magnet is attached, be careful of wiring cables not to apply the load of the Sensor Head and cables to the product.

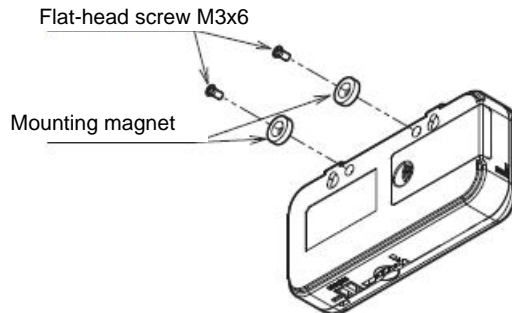
**3.6.3 Mounting with screw hook hole**

There are two hook holes below the convex section of the upper unit. The unit can be easily secured on the wall or other surface.

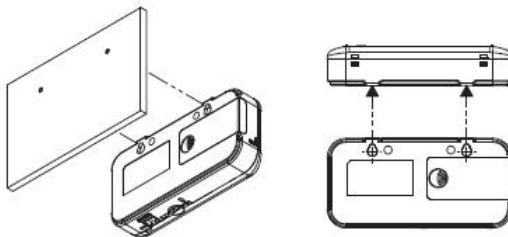

The dimensions to process the screw hook holes are as follows.

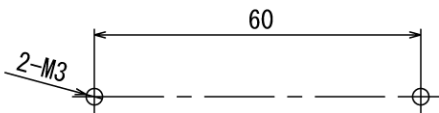

Use M3 screws to hook the screw head on the screw hook holes. Attach the device with an interval of 2.5 mm or more between the bottom of the screw head and the wall surface.

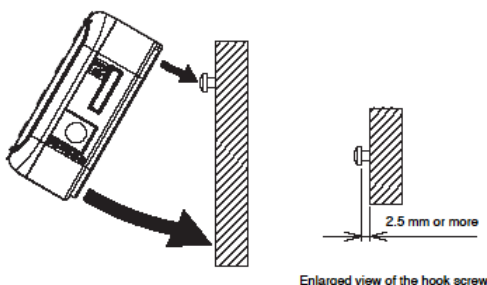
**Important**

- Firmly hold the main unit with your hands to insert or remove the SD memory card from the unit which is mounted with screw hook holes.
- If removing/inserting the SD memory card without fixing the main unit securely, the unit might fall and be damaged.

4. Setting the Unit (Unit Operation)

4.1 Setting Procedure and Operation Modes

This section describes the operation and setting procedure of the unit.

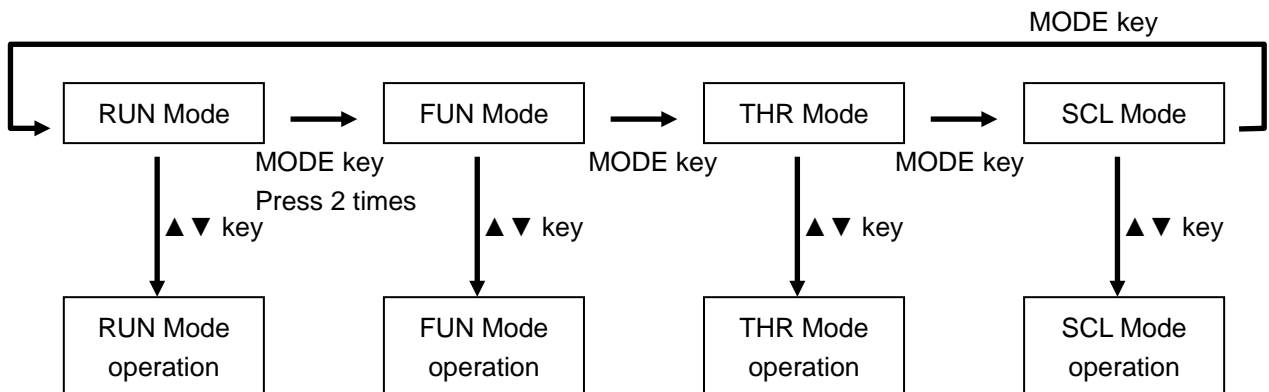

The unit has four operation modes. These modes can be switched with the MODE key.

To change mode from RUN to FUN, press the MODE key twice. When pressing the MODE key once, "RUN" blinks. When pressing it twice, "FUN" blinks to be switched.

Use the ▲ and ▼ keys to change setting items and display items in each operation mode.

Display	Name	Description
RUN ON	Measurement execution mode (RUN mode)	Measures and records differential pressure or temperature and humidity.
FUN blinks	Function setting mode (FUN mode)	Sets measurement and recording.
THR blinks	Threshold value setting mode (THR mode)	Sets threshold values (upper/lower limits) for an alarm output of the differential pressure or temperature and humidity.
SCL blinks	Measurement value adjustment setting mode (SCL mode)	Adjusts measurement value.

Note

- While data is being recorded in the internal memory in RUN mode ("REC" in the display is turned ON), mode cannot be shifted to other than RUN mode.

4.2 Settings in FUN Mode

In FUN mode, settings regarding measurement and recording of the unit are made.

4.2.1 List of setting items

The list below shows the setting items in FUN mode.

Display item	Display	Setting item	Setting value	Factory default
CYCLE	CYCLE	Measurement value update cycle	DPX21 1s (sec) / 2s / 5s / 10s / 20s / 30s / 1m (min) / 2m / 5m / 10m / 20m / 30m / 1h (hour)	10s
		Processing mode	THX21 THX11 10s (sec) / 20s / 30s / 1m (min) / 2m / 5m / 10m / 20m / 30m / 1h (hour)	
MEAS	MEAS	Measurement operation mode	NORM / MAX / MIN / AVE	NORM
MODE	MODE	Measurement value update cycle	DPX21 THX21 NET / SLEEP / PD-S The unit is reset and restarted when operation mode is changed with MODE key after the setting values of NET/SLEEP/PD-S is confirmed.	NET
			THX11 NORM / SLEEP The unit is reset and restarted when operation mode is changed with the MODE key.	NORM
REC	REC	Recording mode	CONT / RING	CONT
INIT	INIT	Return to factory default	When holding the SET/REC/STOP key, initialization starts. After "DONE" is displayed and operation mode is changed with the MODE key, the unit is reset and restarted.	-
ETC (DISP)	RESTR	Read the setting data from the SD memory card.	When inserting the SD memory card and holding the SET/REC/STOP key, the setting data is read from the SD memory card and is set to the main unit. When changing operation mode with the MODE key after DONE has been displayed. The unit is reset and restarted.	-
	BCKUP	Write the setting data into the SD memory card.	When inserting the SD memory card and holding the SET/REC/STOP key, the setting data is saved into the SD memory card.	-
TIME (DISP)	YEAR	YEAR	Year setting	Not initialized by INIT.
	MONTH	MONTH	Month setting	
	DAY	DAY	Day setting	
	CLOCK	CLOCK	Hour: Minute Hour/minute setting	
IP (DISP)	IP1 to IP4	IP	DPX21 THX21 0 to 255	192.168.0.20
	SUB1 to SUB4	SUB		255.255.255.0
SDISP	SDISP	Display mode at sleep	OFF / ON	OFF

4.2.2 Selecting operation mode “FUN”

Press the MODE key to change the operation mode to “FUN”. “FUN” at the lower right of the display blinks.

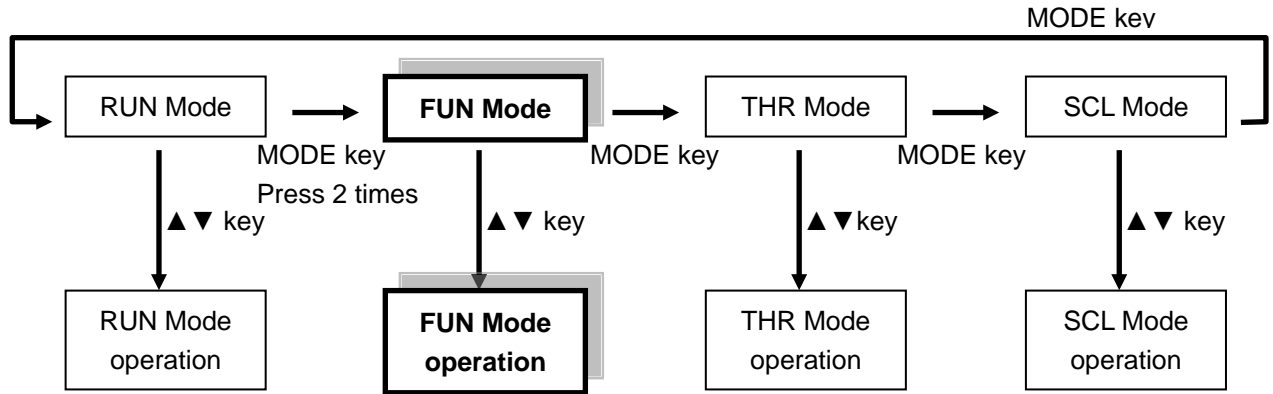
**Note**

- While data is being recorded in the internal memory in RUN mode (“REC” in the display is turned ON), mode cannot be shifted to FUN mode.

4.2.3 Selecting items

Move the items with the Δ and ∇ keys. To change the set value, select an item with Δ or ∇ key and then confirm it with the SET/REC/STOP key. Press the MODE key to change the operation mode.

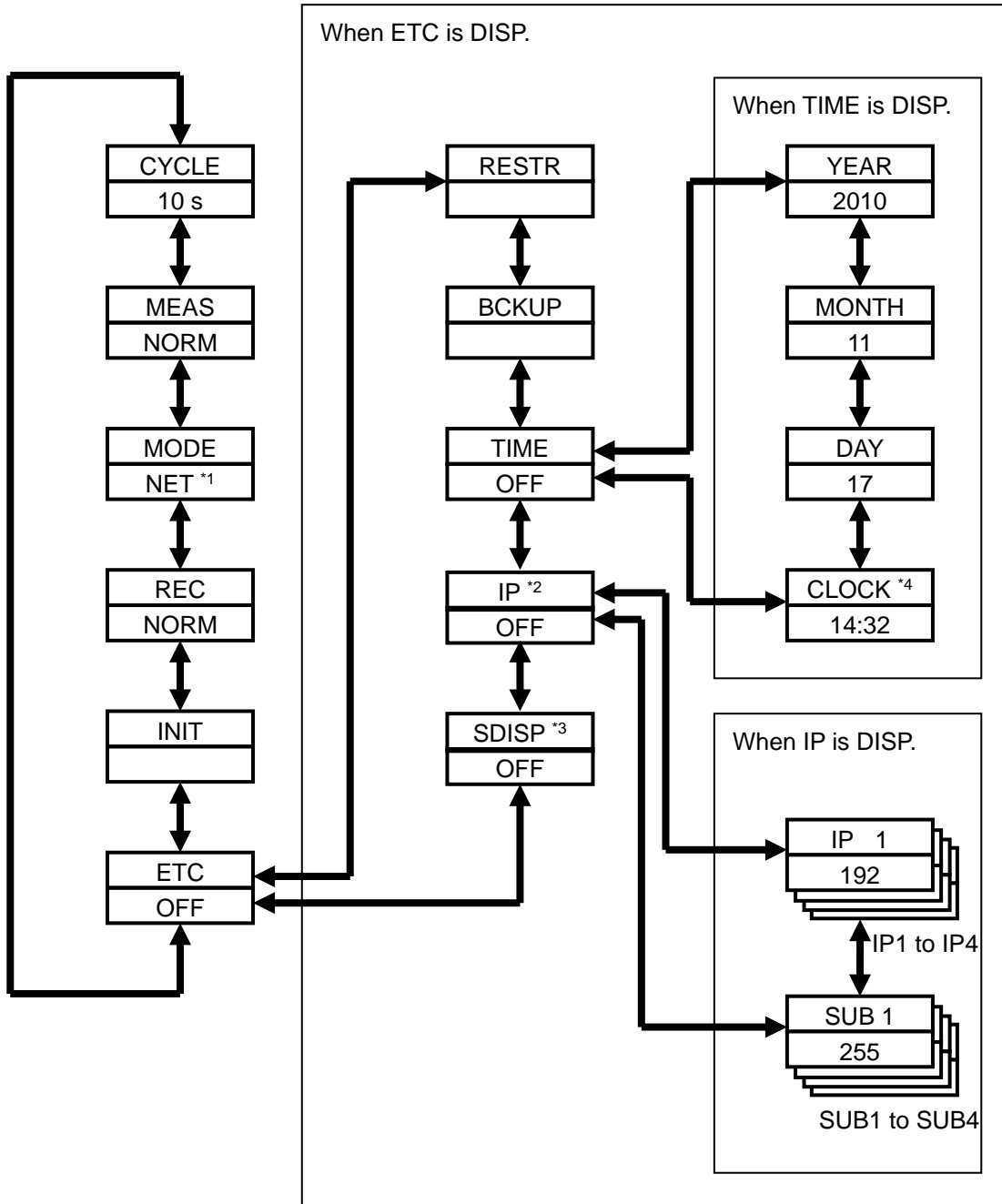

*1: ZN-THX11-S□: NORM

*2: ZN-THX11-S□: Excluded

*3: ZN-THX11-S□: Returns to CYCLE.

*4: ZN-THX11-S□: Returns to SDISP.

4.2.4 Description of items

(1) Measured value update cycle (CYCLE)

Specifies an update interval of measured values.

DPX21

Setting range (selection type):

1s (second) / 2s / 5s / 10s / 20s / 30s / 1m (minute) / 2m / 5m / 10m / 20m / 30m / 1h (hour)

Initial value:

10s

THX21 THX11

Setting range (selection type):

10s (second) / 20s / 30s / 1m (minute) / 2m / 5m / 10m / 20m / 30m / 1h (hour)

Initial value:

10s

(2) Processing mode (MEAS)

Specifies the calculation method of displayed and recorded measured values.

Setting range (selection type):

NORM / MAX / MIN / AVE

Initial value:

NORM

DPX21

Processing mode	Measured value
NORM (Instantaneous value)	Measured values at each measurement update cycle (CYCLE).
MAX (Maximum value)	Maximum value of measured values at every 1 second during the measured value update cycle (CYCLE).
MIN (Minimum value)	Minimum value of measured values at every 1 second during the measured value update cycle (CYCLE).
AVE (Average value)	Average value of measured values at every 1 second during the measured value update cycle (CYCLE).

When the measured value update cycle is set for 10 seconds, the measurement is performed for 10 times every 1 second. When processing mode (MEAS) is set for AVE/MAX/MIN, the maximum/minimum/average values of each 10 measured values are given as the measured values.

THX21 THX11

Processing mode	Measured value
NORM (Instantaneous value)	Measured values at each measurement update cycle (CYCLE).
MAX (Maximum value)	Maximum value of measured values at every 10 seconds during the measured value update cycle (CYCLE).
MIN (Minimum value)	Minimum value of measured values at every 10 seconds during the measured value update cycle (CYCLE).
AVE (Average value)	Average value of measured values at every 10 seconds during the measured value update cycle (CYCLE).

When the measured value update cycle is set for 10 seconds, the measurement is performed for 10 times every 1 second. When processing mode (MEAS) is set for AVE/MAX/MIN, the maximum/minimum/average values of each 6 measured values are given as the measured values.

When processing mode is set for MAX/MIN/AVE, "MAX", "MIN" and "AVE" are turned ON at the lower left of the display.

Note

- When MAX/MIN/AVE is specified as processing mode and the operation mode is switched from "SCL" to "RUN", the display may keep showing "----". This is because the unit waits for the necessary data to be accumulated. The estimated time is as follows:
 - ZN-DPX21-S□ Approx. 1 sec.
 - ZN-THX21-S□, ZN-THX11-S□ Approx. (time that has been set with CYCLE – 10) sec.

(3) Measurement operation mode (MODE)

Specifies the mode of measurement operation.

Measurement operation mode	Operation
NORM	Normal mode
NET	Network connection mode: The unit and PC will be connected via a network to record measured data. Remote setting is also available.
SLEEP	Sleep mode: The unit operates in power saving mode. The CPU enters into standby state except when measuring through measurement value update cycles. As the Ether port also is on standby state, network connection is not available. If SDISP, which is described later, is OFF, the display will not be shown. Even if the display is not shown, you can press any key to resume the display. However, when there is no key operation for 5 seconds, the display will disappear again. Operating the unit in sleep mode is recommended for battery drive.
PD-S	Air Particle Sensor connection mode: Connect an Air Particle Sensor ZN-PD□□-S□ via LAN cable to record the values measured with the Air Particle Sensor in the internal memory of the unit.

DPX21 THX21

Setting range (selection type):

NET / SLEEP / PD-S

Initial value:

NET

THX11

Setting range (selection type):

NORM / SLEEP

Initial value:

NORM

Note

- Change the operation mode with the MODE key after changing the measured operation mode by confirming it with the SET/REC/STOP key. The unit is reset and restarted.

- When the alarm output is ON (including alarm holding state), the power will be consumed even if the unit is set to SLEEP mode. By specifying the threshold value to beyond the assumed range, unnecessary power consumption can be prevented.
- When the display is not shown in SLEEP mode, pressing the key can activate the display only. To execute functions allocated to the key, press the key again after the display is shown.
- In Air Particle Sensor connection mode (PD-S), the unit cannot connect to a PC via a network.

(4) Recording mode (REC)

Specifies the operation for SD memory card writing during data recording.

Setting range (selection type):

CONT / RING

Recording mode	Operation
CONT	Continue mode When the internal memory becomes full during recording, a file is output to the SD memory card to continue recording. If an error occurs due to the SD memory card uninserted, the recording will stop and the data in the internal memory is maintained.
RING	Ring mode When the internal memory becomes full during recording, the internal memory is overwritten from the oldest data to continue recording.

Initial value:

CONT

Note

- By pressing the SET/REC/STOP key (less than 3 seconds) during recording, the data accumulated in the internal memory up to that point can be output to the SD memory card as files while recording continues.

(5) Initialization (INIT)

Initializes the setting values to the factory default (except for year, month, day, hour and minute).

Operation:

Holding the SET/REC/STOP key starts initialization and it is completed when "DONE" is displayed.

When pressing the MODE key after initialization to change the operation mode, the unit will be reset and restarted.

(6) Others (ETC)

Specifies whether or not to display the items of read/write of the setting file and time settings.

Setting range (selection type):

OFF / DISP

Installation value	Operation
OFF	Does not display the items of read/write of the setting data, time setting, and the display setting in sleep mode.
DISP	Displays the items of read/write of the setting data, time setting, and the display setting in sleep mode.

The following item appears when the ▼ key is pressed after the setting is applied with the SET/REC/STOP key.

Setting Value	Item
OFF	CYCLE
TIME	RESTR

□Initial value:

OFF

Note

- ETC returns to OFF after restarting.

(7) Reading setting data (RESTR)

Restore the settings of the main unit by using SD memory card in which the setting data has been saved as a backup with BCKUP (described later).

□Operation:

Insert the SD memory card in which the setting data has been saved, and hold the SET/REC/STOP key. Reading completes when “DONE” is displayed.

When pressing the MODE key to change the operation mode, the unit will be reset and restarted.

Note

- The number of the setting data items that can be stored in one SD memory card as a backup is one for a unit. The setting data that has been backed up with a unit can be restored with another unit.
- When ETC is OFF, the setting data cannot be read.

(8) Writing the setting data (BCKUP)

Saves the setting data of the Differential Pressure Station unit into the SD memory card.

□Operation:

Insert an SD memory card and hold the SET/REC/STOP key.

Saving is complete when “DONE” is displayed.

Important

- The number of the setting data items that can be stored in one SD memory card as a backup is one for a unit.
- When performing a backup using the SD memory card in which the setting data has already been backed up, the setting data will be overwritten. The data will also be overwritten if a backup is performed on another unit.

Note

- The setting data is written into the system folder of the SD memory card.
- When ETC is OFF, reading of the setting data cannot be performed.

(9) Setting time (TIME)

Specifies the time setting.

Setting range (selection type):

OFF / DISP

Installation value	Operation
OFF	Time cannot be set.
DISP	Time can be set.

The following item appears when the ▼ key is pressed after the setting is applied with the SET/REC/STOP key.

Setting Value	Item
OFF	IP
TIME	YEAR

Initial value:

OFF

Note

- When ETC is OFF, TIME cannot be specified.
- After a restart, TIME returns to OFF.

(10) YEAR, MONTH, DAY, CLOCK

Sets year, month, day and time.

Setting range (numeric value input type):

YEAR: 2000 to 2099

MONTH: 1 to 12

DAY: 1 to 31

CLOCK: 00:00 to 23:59

Note

- When ETC is OFF and TIME is OFF, the year, month, day, hour and minute cannot be set.

(11) Setting IP address (IP) DPX21 THX21

Specifies whether setting IP address or not.

Setting range (selection type):

OFF / DISP

Setting value	Operation
OFF	IP address cannot be set.
DISP	IP address can be set.

The following item appears when the ▼ key is pressed after the setting is applied with the SET/REC/STOP key.

Setting Value	Item
OFF	SDISP
TIME	IP 1

Initial value:

OFF

Note

- When ETC is OFF, IP cannot be specified.
- After a restart, IP returns to OFF.

(12) IP address and subnet mask (IP 1 to IP 4, SUB 1 to SUB 4)

DPX21

THX21

Sets 4 segments of the IP address (IP 1 to IP 4) and 4 segments of the subnet mask (SUB 1 to SUB 4).

Setting range (numeric value input type):

IP 1, IP 2, IP 3, IP 4: 0 to 255

SUB 1, SUB 2, SUB 3, SUB 4: 0 to 255

Initial value:

IP 1. IP 2. IP 3. IP 4 = 192.168.0.20

SUB 1. SUB 2. SUB 3. SUB 4 = 255.255.255.0

Note

- The unit will be reset and restarted after changing the IP address and subnet mask after confirmation with the SET/REC/STOP key and change the operation mode with the MODE key.
- When ETC is OFF and IP is OFF, the IP address and Subnet mask cannot be set.

(13) Display mode at sleep (SDISP)

Specifies whether or not performing display during operation in sleep mode.

Setting range (selection type):

OFF / ON

Setting value	Operation
OFF	If there is no operation for 5 seconds during operation in sleep mode, the display disappears. When any key is pressed, the display will be restarted.
ON	Continues the display even during operation in sleep mode.

Initial value:

OFF

Refer to: 4.2.4(3) Measurement operation mode (MODE)

Note

- Pressing the key when the display is not shown in SLEEP mode only specifies to restart the display. To execute functions allocated to the key, press the key again after the display is shown again.
- When ETC is OFF, SDISP cannot be specified.

4.2.5 Changing the setting value

There are two specification types: the selection type to select among the predetermined options, and to input the numeric value.

(1) Changing the setting value of the selection type (Example: Changing CYCLE)

Press the MODE key several times to enter FUN mode, and then press the ▼ or ▲ key to display CYCLE.

Display (upper line/ lower line)	Operation
CYCLE 10 s	Press the MODE key repeatedly until "FUN" will blink. Press the ▼ or ▲ key to display CYCLE in the upper line of the display. When pressing the SET/REC/STOP key, the value in the lower line blinks.
↓ SET/REC/STOP key	
CYCLE 10 s ↑ blinks	Settable values are displayed in sequence by pressing the ▼ or ▲ key. When pressing the MODE key, the setting is cancelled.
↓ ▼ or ▲ key	
CYCLE 30 s ↑ blinks	Press the ▼ or ▲ key to display the desired value, and then press the SET/REC/STOP key. The value will be confirmed and blinking will stop.
↓ SET/REC/STOP key	
CYCLE 30 s	

After the settings above, has done, the setting items can be changed again with the ▼ or ▲ key, and the operation mode can be changed with the MODE key as well.

(2) Changing the setting value of the numeric value input type (Example: Changing YEAR)

Press the MODE key several times to enter FUN mode, and then press the ▼ or ▲ key to display YEAR.

To display YEAR, ETC and TIME need to be set to DISP.

Display (upper line/ lower line)	Operation
CYCLE 10 s ("FUN" blinks)	Press the MODE key repeatedly until "FUN" will blink. "CYCLE" is displayed in the upper line. Press the ▼ or ▲ key to display YEAR. To display YEAR, ETC and TIME need to be set to DISP.
↓ ▼ or ▲ key	
YEAR 2010	When pressing the SET/REC/STOP, the least significant digit in the lower line blinks.
↓ SET/REC/STOP key	
YEAR 2010 ↑ blinks	When pressing the ▼ or ▲ key, the value increases/decreases. When holding the ▼ or ▲ key, the range of increase/decrease becomes wider. When pressing the MODE key at this point, the setting is cancelled.
↓ ▼ or ▲ key	
YEAR 2011 ↑ blinks	Press the ▼ or ▲ key to display the desired value, and then press the SET/REC/STOP key. The value will be confirmed and blinking will stop.
↓ SET/REC/STOP key	
YEAR 2011	

After the settings above, the setting items can be changed with the ▼ or ▲ key, and the operation mode can be changed with the MODE key.

4.3 Making Settings (Operation in THR Mode)

Set the upper limit and lower limit values of the differential pressure regarding the alarm output of the unit in THR mode.

When the measured value is either larger than the upper limit or smaller than the lower limit during operation in RUN mode, the alarm output terminal turns ON and "ALM" on the display turns ON.

When returned from the alarm state during measurement, you can set whether or not the alarm output state is maintained.

Note

- Alarm monitoring cannot be stopped.
- To avoid alarm monitoring, set each threshold value to beyond the assumed measurement range. The factory default has been set as non-alarm monitoring (setting the alarm upper/lower limit to be measurable).

4.3.1 Selecting operation mode

Press the MODE key to change the operation mode to "THR". "THR" at the lower right of the display blinks.

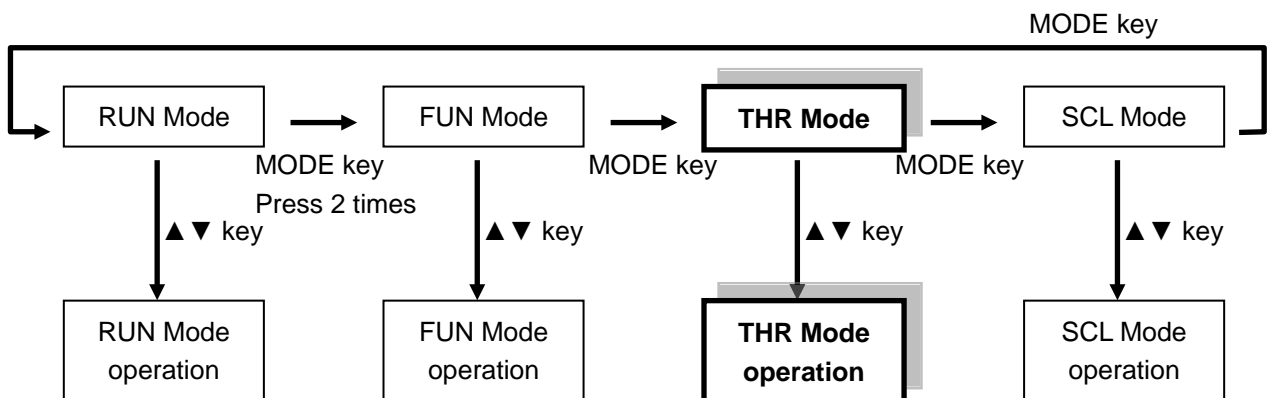

4.3.2 List of setting items

The table below shows a list of setting items in THR mode.

Display item	Display	Setting item	Apply	
			DPX21	THX21 THX11
DP HI	<i>dP H.</i>	Upper limit of the differential pressure threshold value	Yes	
DP LO	<i>dP Lo</i>	Lower limit of the differential pressure threshold value	Yes	
DEGHI	<i>dEGH.</i>	Upper limit of temperature threshold value		Yes
DEGLO	<i>dEGLo</i>	Lower limit of temperature threshold value		Yes
RH HI	<i>rH H.</i>	Upper limit of humidity threshold value		Yes
RH LO	<i>rH Lo</i>	Lower limit of humidity threshold value		Yes
HOLD	<i>HoLd</i>	Alarm hold setting	Yes	Yes

4.3.3 Selecting items

Move the items with the \triangle and ∇ keys. To change the set value, select an item with \triangle or ∇ key and then confirm it with the SET/REC/STOP key. Press the MODE key to change the operation mode.

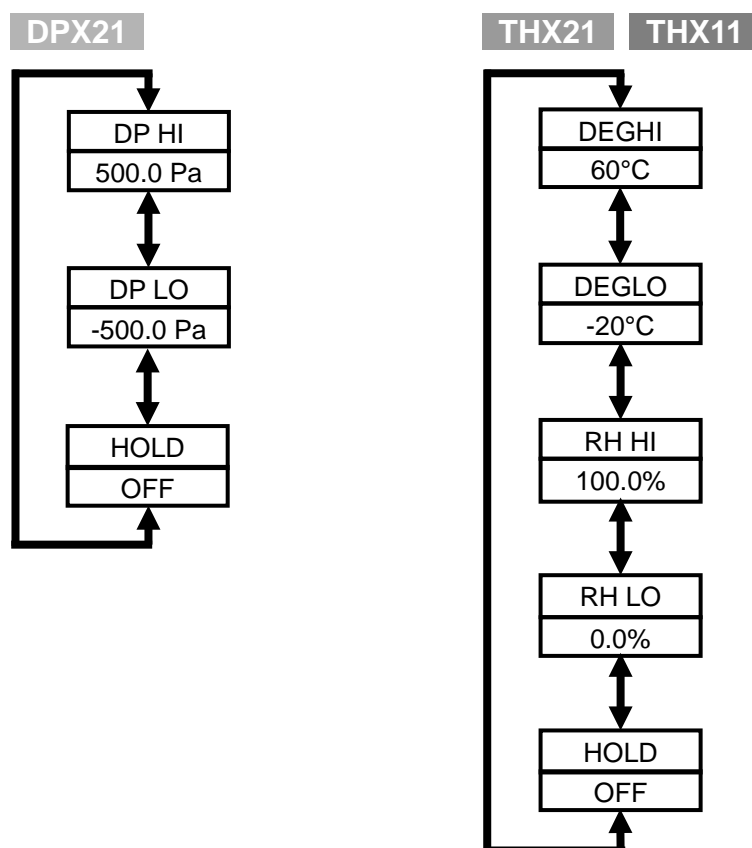

4.3.4 Description of items

(1) Upper limit of the differential pressure threshold value (DP HI) **DPX21**

Sets the upper limit of the differential pressure threshold value for an alarm output.

When the measured differential pressure is higher than the set value, "ALM" and the alarm output are turned ON.

Setting range (numeric value input type):

-500.0 Pa to 500.0 Pa

Initial value:

500.0 Pa

(2) Lower limit of the differential pressure threshold value (DP LO) **DPX21**

Sets the lower limit of the differential pressure threshold value for an alarm output.

When the measured differential pressure is lower than the set value, "ALM" and the alarm output are turned ON.

Setting range (numeric value input type):

-500.0 Pa to 500.0 Pa

Initial value:

-500.0 Pa

(3) Upper limit of the temperature threshold value (DEGHI) THX21 THX11

Sets the upper limit of the temperature threshold value for an alarm output.

When the measured temperature is higher than the set value, "ALM" and the alarm output are turned ON.

Setting range (numeric value input type):

-20.0 °C to 60.0 °C

Initial value:

60.0 °C

(4) Lower limit of the temperature threshold value (DEGLO) THX21 THX11

Sets the lower limit of the temperature threshold value for an alarm output.

When the measured temperature is lower than the set value, "ALM" and the alarm output are turned ON.

Setting range (numeric value input type):

-20.0 °C to 60.0 °C

Initial value:

-20.0 °C

(5) Upper limit of the humidity threshold value (RH HI) THX21 THX11

Sets the upper limit of the humidity threshold value for an alarm output.

When the measured humidity is higher than the set value, "ALM" and the alarm output are turned ON.

Setting range (numeric value input type):

0.0 % to 100.0 %

Initial value:

100.0 %

(6) Lower limit of the humidity threshold value (RH LO) THX21 THX11

Sets the lower limit of the humidity threshold value for an alarm output.

When the measured humidity is lower than the set value, "ALM" and the alarm output are turned ON.

Setting range (numeric value input type):

0.0 % to 100.0 %

Initial value:

0.0 %

(7) Setting alarm hold

Set whether or not for the alarm output ON state and "ALM" ON state on the display to be maintained when the measured value is returned to within the range of upper/lower limit of the threshold value from outside of the range (alarm state) during measurement in RUN mode.

To release the alarm from the maintained state, hold the MODE key (at least 3 seconds) for "ALM" to turn off, then the alarm output stops.

- Setting range (selection type):
 - OFF: Maintains an alarm output ON state.
 - ON: Maintains the alarm output ON state.
- Initial value:
 - OFF

4.3.5 Changing the setting value

Change the value in the same way as changing the settings in FUN mode.

Refer to: 4.2.5 Changing the setting value

4.4 Making Settings (Operation in SCL Mode)

The adjustment of the measured value of the unit is set in SCL mode. Adjust the values to be displayed or recorded by adding or subtracting by the predetermined setting values for the values measured with the unit (offset).

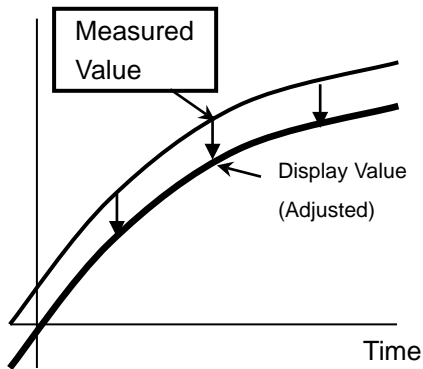

4.4.1 Selecting operation mode

Press the MODE key to change the operation mode to "SCL". "SCL" at the lower right of the display will blink.

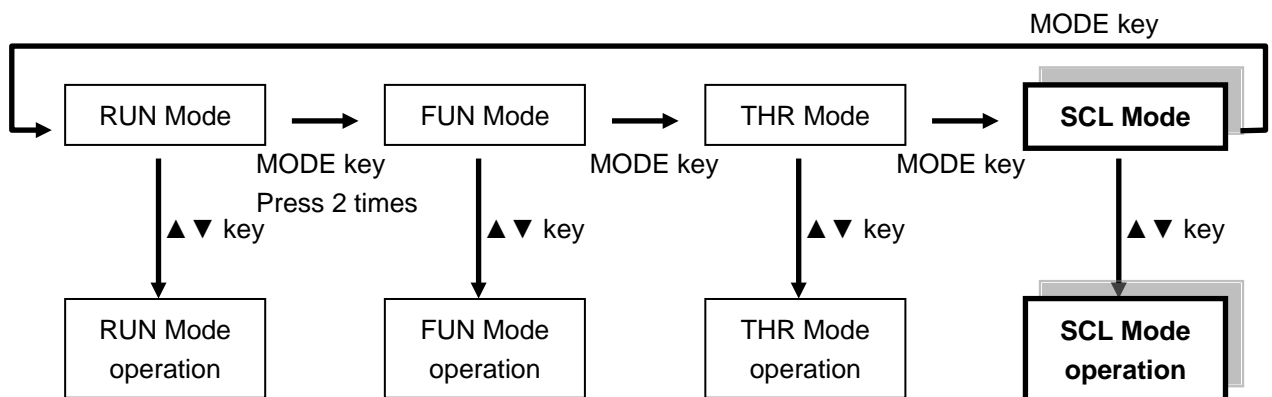

4.4.2 List of setting items

The table below shows a list of setting items in SCL mode.

DPX21

Setting item	Display	Factory default
Differential pressure adjustment	Upper line: Measured differential pressure Lower line: Value after adjustment	Values of the upper and lower lines are equal. (not adjusted)

THX21 THX11

Setting item	Display	Factory default
Temperature adjustment	Upper line: Measured temperature Lower line: Value after adjustment	Values of the upper and lower lines are equal. (not adjusted)
Humidity adjustment	Upper line: Measured humidity Lower line: Value after adjustment	Values of the upper and lower lines are equal. (not adjusted)

4.4.3 Selecting items

Move the select items with the ▲ and ▼ keys. To change the set value, select an item with ▼ and ▲ keys and then confirm it with the SET/REC/STOP key. Press the MODE key to change the operation mode. There is only one mode for the Differential Pressure Station.

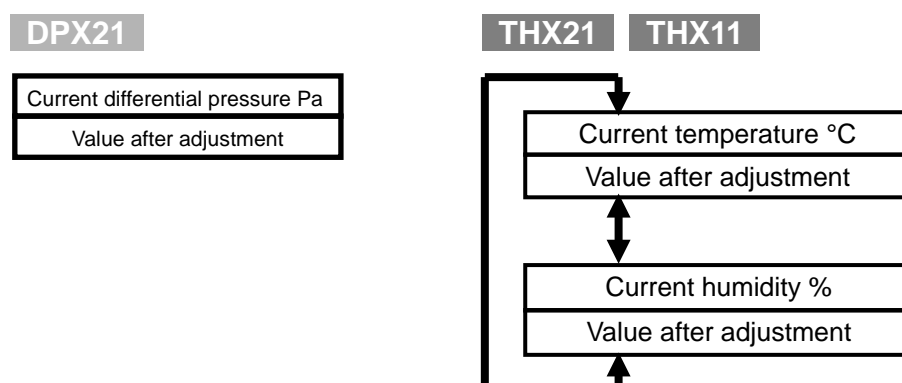

4.4.4 Description of items

(1) Adjusting differential pressure **DPX21**

The differential pressure measurement value is displayed on the upper line, and the value after adjustment on the lower line.

The value will not be adjusted if in the lower line you set the value after adjustment to the same as the value currently displayed on the upper line. If a different value is set, the difference between the values in the upper line and the lower line will be added to the measured value as an offset value. The adjustment range is ± 50.0 Pa.

When adjustment has been set, "SCL" is ON during measurement in RUN mode.

Setting range (numeric value input type):

-50.0 Pa (Displayed value in the upper line) to +50.0 Pa (Displayed value in the upper line)

Initial value:

The same value as the measured value (not adjusted)

(2) Adjusting temperature **THX21** **THX11**

The temperature measurement value is displayed in the upper line, and the value after adjustment in the lower line.

The value will not be adjusted if in the lower line you set the value after adjustment to the same as the value currently displayed in the upper line. If a different value is set, the difference between the values in the upper line and the lower line will be added to the measured value as an offset. The adjustment range is ± 10.0 °C.

When adjustment has been set, "SCL" is ON during measurement in RUN mode.

Setting range (numeric value input type):

-10.0 °C (Displayed value in the upper line) to +10.0 °C (Displayed value in the upper line)

Initial value:

The same value as the measured value (not adjusted)

(3) Adjusting humidity **THX21** **THX11**

The humidity measurement value is displayed in the upper line, and the value after adjustment in the lower line.

The value will not be adjusted if in the lower line you set the value after adjustment to the same as the value currently displayed in the upper line. If a different value is set, the difference between the values in the upper line and the lower line will be added to the measured value as an offset. The adjustment range is ± 10.0 °C.

When adjustment has been set, "SCL" is ON during measurement in RUN mode.

Setting range (numeric value input type):

-10.0 % (Displayed value in the upper line) to +10.0 % (Displayed value in the upper line)

Initial value:

The same value as the measured value (not adjusted)

4.4.5 Changing the setting value

Change the value in the same way as changing the settings in FUN mode.

Refer to: 4.2.5 Changing the setting value

4.5 Copying the Settings When Using Multiple Units

The settings can be the same among multiple units by reading the setting data from one unit to the other using the SD memory card to which setting data has been written on a certain unit. If the settings are shared among multiple units, only one unit needs to be set through the unit operation, and the rest of the units can be set by restoring them. This contributes to less setting time and less miss-settings.

Refer to: 4.2.4(7) Reading setting data (RESTR), 4.2.4(8) Writing the setting data (BCKUP)

5. Measurement and Recording (Unit Operation)

5.1 Overview

There are two methods to record measured values; recording in a unit, and recording in a PC via a network (except for ZN-THX11-S□). This chapter describes recording to the unit.

5.2 Selecting Operation Mode

Differential pressure, temperature and humidity are measured in RUN mode.

Press the MODE key to change the operation mode to "RUN". "RUN" at the bottom right of the display turns ON.

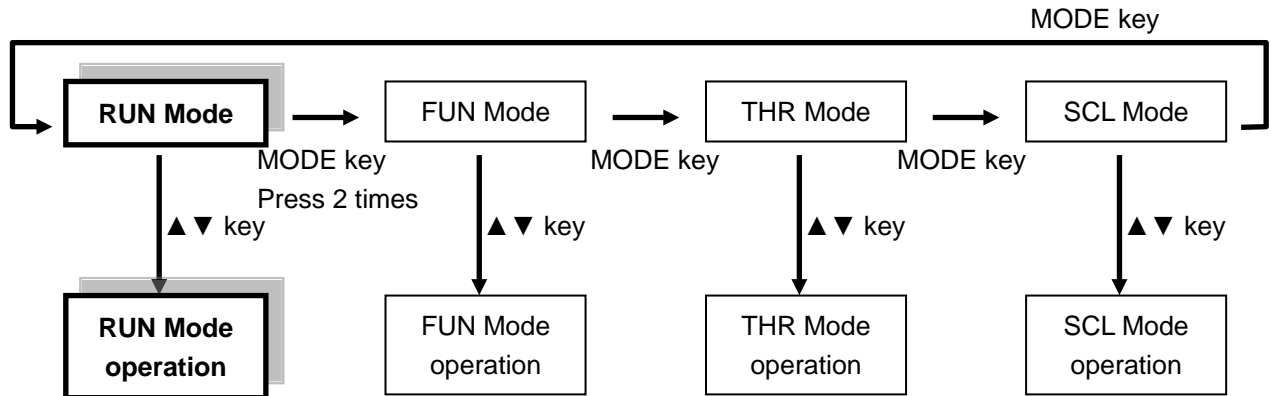

Note

- Move to another mode other than to RUN mode is prohibited during recording.
- When mode has been changed from other mode to RUN mode, "----" may be displayed for a long period of time.

When processing mode is MAX/MIN/AVE:

ZN-DPX21-S□

Approx. 1 sec.

ZN-THX21-S□/ZN-THX11-S□

Approx. (time that has been set in CYCLE – 10) seconds

5.3 Screen Transition in RUN Mode

Pressing the ∇ or \triangle key in RUN mode switches the display as follows. Pressing the MODE key changes the operation mode.

5.3.1 ZN-DPX21-S

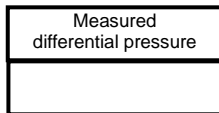

The differential pressure measurement value (Pa) is displayed in the upper line.

If computation for the measured value has been set, the value after computation is displayed with "MAX"/"MIN"/"AVE" and "RUN" turned ON. If adjustment has been set, the value after adjustment is displayed with "SCL" and "RUN" turned ON.

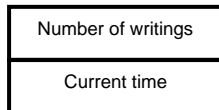

The number of writings to the internal memory since the recording start is displayed in the upper line, the current time is displayed in the lower line.

When measured data is written in the internal memory per time cycle specified by measurement update cycle (CYCLE), the value in the upper line increases by 1. When the internal memory becomes full, "FULL" is displayed. If the data accumulated in the internal memory is written to the SD memory card due to an event such as the SET/REC/STOP key having been pressed during recording, the value will be cleared to 0.

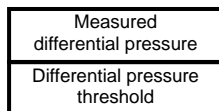

The differential pressure measurement value (Pa) is displayed in the lower line and differential pressure threshold value is displayed in the lower line. The threshold value is displayed alternately between upper limit (Hi) and lower limit (Lo).

If computation has been set, a differential pressure measurement value after computation is displayed with "MAX"/"MIN"/"SCL" and "RUN" turned ON.

If adjustment has been set, a differential pressure measurement value after adjustment is displayed with "SCL" and "RUN" turned ON.



Returns to the differential pressure display.

5.3.2 ZN-THX21-S / ZN-THX11-S

Measured
Measured humidity

Temperature measurement value (°C) is displayed in the upper line and humidity measurement value (%) is displayed in the lower line.

If computation for the measured value has been set, the value after computation is displayed with "MAX"/"MIN"/"AVE" and "RUN" turned ON. If adjustment has been set, the value after adjustment is displayed with "SCL" and "RUN" turned ON.



Number of writings
Current time

The number of writings to the internal memory since the recording start is displayed in the upper line, the current time is displayed in the lower line.

When measured data is written in the internal memory per time cycle specified by measurement update cycle (CYCLE), the value in the upper line increases by 1. When the internal memory becomes full, "FULL" is displayed. If the data accumulated in the internal memory is written to the SD memory card due to an event such as the SET/REC/STOP key having been pressed during recording, the value will be cleared to 0.



Measured
Temperature

Temperature measurement value (°C) is displayed in the upper line and temperature threshold value is displayed in the lower line. The threshold value is displayed alternately between upper limit (Hi) and lower limit (Lo).

If computation has been set, a temperature measurement value after computation is displayed with "MAX"/"MIN"/"SCL" and "RUN" turned ON. If adjustment has been set, a temperature measurement value after adjustment is displayed with "SCL" and "RUN" turned ON.



Measured humidity
Humidity threshold

Humidity measurement value (°C) is displayed in the upper line and threshold value is displayed in the lower line. The threshold value is displayed alternately between upper limit (Hi) and lower limit (Lo).

If computation has been set, a humidity measurement value after computation is displayed with "MAX"/"MIN"/"SCL" and "RUN" turned ON. If adjustment has been set, a humidity measurement value after adjustment is displayed with "SCL" and "RUN" turned ON.

Returns to the temperature/humidity display.

Note

- "REC" turns ON during data recording.
- "ALM" turns ON when the measured value exceeds the upper limit threshold value or when the measured value falls short of the lower limit threshold value and the alarm output is turned ON. When the alarm hold has been set, the alarm output state is maintained and "ALM" keeps turned ON even if the alarm state is released. Hold the MODE key to stay alarm.
- "MAX", "MIN" and "AVE" turn ON when processing mode has been set to MAX, MIN and AVE. They are not displayed in "NORM".

5.4 Starting/Stopping Recording

5.4.1 Starting recording

When holding the SET/REC/STOP key (for at least 3 seconds) in RUN mode, recordings of the differential pressure data start and “REC” turns ON.

The measured data is recorded and accumulated in the internal memory, and is output as a CSV file into the SD memory card when the SET/REC/STOP key is pressed.

Important

- If a recording starts when the recorded data still remained in the internal memory, the recorded data will be lost. When pressing the SET/REC/STOP key for less than 3 seconds before recording, the file can be output to the SD memory card. A state in which the recorded data remains in the internal memory occurs due to a power failure or the reset switch being pressed during recording and therefore the Differential Pressure Station restarted. If a recording stop operation is performed properly, the recorded data will not be remained.
- In RUN mode, press the ∇ or \triangle key to display the time at the lower line. If the value in the lower line is 0, there is no recorded data in the internal memory.

Note

- The SD memory card is not always required to be inserted during recording. However, it needs to be inserted when pressing the SET/REC/STOP key or while the recording is stopped.
- Move to another mode other than to RUN mode is prohibited during recording.

5.4.2 Stopping Recording

When pressing the SET/REC/STOP key (for at least 3 seconds) while “REC” is turned ON during recording, the recording stops and the file is output to the SD memory card, and “REC” is turned OFF.

Important

- Be sure to insert a writable SD memory card when recording stops.
- Even though the writing to the SD memory card failed, recording will not stop.
- If the SD memory card cannot be ready when you want to change the operation mode due to setting changes, press the reset switch or shut down the power supply and then restart the unit. Although the data recorded in the internal memory before a restart will be maintained even after the restart, the data will be lost after recording starts. Insert the SD memory card before starting recording and press the SET/REC/STOP key to output the file.

5.5 Outputting the File to SD memory card

The data recorded in the SD memory card is output to files in the following conditions.

- (1) The SET/REC/STOP key has been pressed during recording (less than 3 seconds). Recording to the internal memory continues.
- (2) The SET/REC/STOP key has been pressed during recording (at least 3 seconds). Recording to the internal memory stops.

Refer to: 5.4.2 Stopping Recording

- (3) The content of the internal memory has become full. Recording to the internal memory continues. (Only when the recording mode is set to be continue mode.)

Refer to: 4.2.4(4) Recording mode (REC)_

- (4) Not during a recording but the SET/REC/STOP key was pressed when the recorded data still remains in the internal memory (less than 3 seconds, RUN mode). Such situation occurs after a restart of the unit due to a power failure or the reset switch being pressed during recording.

5.6 Releasing the Held Alarm

“ALM” turns ON when the measured value exceeds the upper limit threshold value or when the measured value falls short of the lower limit threshold value. Then the alarm output is turned ON. When the alarm hold setting is ON, the alarm output state is maintained and “ALM” keeps turned ON even if the alarm state is released.

To release the held alarm, hold the MODE key for at least 3 seconds.

Refer to: 4.3.4(7) Setting alarm hold

5.7 Hiding the Display

During operation in RUN mode, if no operation is performed in 5 seconds, the display may disappear. In this case, measurement operation mode is set to be sleep mode and the sleep display mode is OFF. Recording continues during recording even if the display is not shown.

Press any key to restart the display. Pressing the key when the display is not shown can only activate the display. To execute functions allocated to the key, press the key again after the display is shown.

Refer to: 4.2.4(3) Measurement operation mode (MODE), 4.2.4(13) Display mode at sleep (SDISP)

6. Connecting with Air Particle Sensor (ZN-PD□□-S□)

DPX21 THX21

6.1 Connection setting of the unit

To connect the unit with Air Particle Sensor (ZN-PD□□-S□), set the unit as follows.

Setting item		Setting value
Differential Pressure Station Thermo-Humidity Station	Measurement operation mode (MODE)	PD-S
	IP address	192.168.0.20 (factory default)
	Subnet mask	255.255.255.0 (factory default)
Air Particle Sensor (ZN-PD□□-S□)	IP address	192.168.0.10
	Subnet mask	255.255.255.0

Set the measurement operation mode of the unit according to "4. Setting (Unit Operation).

Refer to: 4 Setting the Unit (Unit Operation)

Regarding the Air Particle Sensor (ZN-PD□□-S□), read the Instruction Sheet of the Air Particle Sensor (ZN-PD□□-S□).

6.2 Recording

By starting recording operation of the unit, the measured values of differential pressure, temperature or humidity of the unit and particle values of the Air Particle Sensor (ZN-PD□□-S□) can be recorded.

Refer to: 5 Measurement and Recording (Unit Operation)

Note

- Although the measured particle values are recorded as the recorded data, they cannot be shown on the display of the unit.
- When an Air Particle Sensor (ZN-PD□□-S□) is connected to the Air Thermo Station, these values are recorded as well.

6.3 Displaying Graph

The particle values as well as temperature and humidity recorded in the unit can be displayed graphically using the PC software such as Multi Data Viewer or SD Viewer ES.

Output the recorded data to the SD memory card on the unit, and insert it into the SD card slot of the PC to open CSV files with Multi Data Viewer or SD Viewer ES.

7. Appendix

7.1 Ratings and Performance

7.1.1 ZN-DPX21-S

Item	ZN-DPX21-S	ZN-DPX21-SA
Connectable sensor	Differential Pressure Ssensor Head ZN-DPS1□□-S	
Display	LCD 7-seg 5-digit 2-step display, auxiliary information indicator display	
Measurement cycle	1s,2s,5s,10s,20s,30s,1min,2min,5min,10min,20min,30min,1h	
Processing mode	Instantaneous value, maximum value, minimum value, average value	
Measurement operation mode	Network connection mode, sleep mode ^{*1} , air particle sensor communication mode ^{*2}	
Recording mode	Continue ^{*3} , ring ^{*4}	
Externla output	Alarm output ^{*5} (photocoupler output) Alarm hold is configurable.	
Communication interface	Ethernet (10BASE-T, 100BASE-TX)	
Memory capacity (internal)	Internal memory: Approx. 11,000 data items ^{*6}	
Storage device (external)	SD memory card (SDHC support, measured value saving/set value saving and reading), Recommended SD memory card: HMC-SD292 (2GB) / HMC-SD492 (4GB) (manufactured by OMRON) ^{*7}	
Power supply	DC input: 24 VDC±10%, AC adapter: 100 to 240 VAC/50 to 60 Hz, Battery: 2 AAA batteries ^{*8}	
Current consumption	70 mA max. (AC adapter used)	
Battery life ^{*9}	Approx. 1 year (sleep mode) Approx. 2 hours (network connection mode, air particle connection mode) Both require measurement interval of 10 minutes with 2 AAA nickel metal hydride batteries, with SD memory card not inserted	
Operating temperature	Main unit: 0 to 60°C, AC adapter: 0 to 40°C	
Storage temperature	-15 to 60°C (no condensation or icing)	
Operating humidity	20 to 85%RH (no condensation)	
Storage humidity	20 to 85%RH (no condensation or icing)	
Insulation resistance	20 MΩ (500 VDC)	
Withstand voltage	1000 VAC, 50/60 Hz 1 min	
Vibration resistance	10 to 150 Hz, 0.7 mm double amplitude, acceleration: 50 m/s ² for each in X, Y and Z directions for 80 min ^{*10}	
Shock resistance	150 m/s ² in 6 directions (+/-X, +/-Y, and +/-Z directions), 3 times each ^{*10}	
Material	ABS	
Degree of protection	IP30	
Mounting method	Screw mounting, hook, floor installation	
Dimensions (WDH)	117.2×24.6×56.8 mm (excluding protruding part)	
Weight (packaged)	Approx. 500g	
Accessories 1	Instruction sheet, Startup guide, Alarm output connector ^{*11}	
Accessories 2	AC adapter	DC cable, Ferrite core

*1 Power saving mode. The display is always OFF in default setting (It turns ON with button operation). Network communication with the host device is not available.

- *2 A mode in which a Differential Pressure Station is connected with an Air Particle Sensor (ZN-PD□□-S) by LAN cable to log the particle count value and differential pressure data to the SD memory card simultaneously.
- *3 Automatically writes data into the SD memory card when the internal memory reaches the upper limit, and continues recording until the SD memory card will reach the capacity limit. If the SD memory card is not inserted when the internal memory reaches the upper limit, recording ends. (Data can be output to the SD memory card by pressing the button after inserting the SD memory card.)
- *4 A mode to record the latest measurement value for the maximum capacity of the internal memory at all times. (When reaching the upper limit of the internal memory, data item will be discarded from the oldest.)
- *5 Output when the value exceeds the upper limit that has been set in threshold value setting mode, or falls short of the lower limit.
- *6 Except for Air Particle Sensor connection mode.
- *7 When using a third party SD card, it is recommended to use a reliable and durable industrial SD card (SD standard or SDHC standard (not compliant with SDXC standard), Class 4 or higher, flash memory type SLC or MLC type). You must confirm the operation of the SD card yourself.
- *8 Nickel metal hydride batteries or alkaline batteries can be used. Manganese batteries cannot be used.
- *9 The battery life varies according to measurement environment, sampling, measurement operation mode, battery's type and performance.
- *10 In case using Mounting Magnet ZN9-EM01-S (sold separately), install the product in a location where impact is not applied.
Vibration resistance is 10 to 50 Hz, double amplitude 0.3 mm, acceleration 20 m/s², 50 min for each in X, Y and Z directions.
- *11 The attached connector is XW4B-02B1-H1.

7.1.2 ZN-THX21-S

Item	ZN-THX21-S	ZN-THX21-SA
Connectable sensor	Air Particle Sensor Head ZN-THS1□□-S□	
Display	LCD 7-seg 5-digit 2-step display, auxiliary information indicator display	
Measurement cycle	10s,20s,30s,1min,2min,5min,10min,20min,30min,1h	
Processing mode	Instantaneous value, maximum value, minimum value, average value	
Measurement operation mode	Network connection mode, sleep mode ^{*1} , air particle sensor communication mode ^{*2}	
Recording mode	Continue ^{*3} , ring ^{*4}	
Externla output	Alarm output ^{*5} (photocoupler output) Alarm hold is configurable.	
Communication interface	Ethernet (10BASE-T, 100BASE-TX)	
Memory capacity (internal)	Internal memory: Approx. 8,500 data items ^{*6}	
Storage device (external)	SD memory card (SDHC support, measured value saving/set value saving and reading), Recommended SD memory card: HMC-SD292 (2GB) / HMC-SD492 (4GB) (manufactured by OMRON) ^{*7}	
Power supply	DC input: 24 VDC±10%, AC adapter: 100 to 240 VAC/50 to 60 Hz, Battery: 2 AAA batteries ^{*8}	
Current consumption	70 mA max. (AC adapter used)	
Battery life ^{*9}	Approx. 1 year (sleep mode) Approx. 2 hours (network connection mode, air particle connection mode) Both require measurement interval of 10 minutes with 2 AAA nickel metal hydride batteries, with SD memory card not inserted	
Operating temperature	Main unit: 0 to 60°C, AC adapter: 0 to 40°C	
Storage temperature	-15 to 60°C (no condensation or icing)	
Operating humidity	20 to 85%RH (no condensation)	
Storage humidity	20 to 85%RH (no condensation or icing)	
Insulation resistance	20 MΩ (500 VDC)	
Withstand voltage	1000 VAC, 50/60 Hz 1 min	
Vibration resistance	10 to 150 Hz, 0.7 mm double amplitude, acceleration: 50 m/s ² for each in X, Y and Z directions for 80 min ^{*9}	
Shock resistance	150 m/s ² in 6 directions (+/-X, +/-Y, and +/-Z directions), 3 times each ^{*9}	
Material	ABS	
Degree of protection	IP30	
Mounting method	Screw mounting, hook, floor installation	
Dimensions (WDH)	117.2×24.6×56.8 mm (excluding protruding part)	
Weight (packaged)	Approx. 500g	
Accessories 1	Instruction sheet, Startup guide, Alarm output connector ^{*11}	
Accessories 2	AC adapter	DC cable, Ferrite core

*1 Power saving mode. The display is always OFF in default setting (It turns ON with button operation). Network communication with the host device is not available.

*2 A mode in which an Thermo-Humidity Station is connected with an Air Particle Sensor (ZN-PD□□-S□) by LAN cable to log the particle count value and temperature/humidity data to the SD memory card simultaneously.

*3 Automatically writes data into the SD memory card when the internal memory reaches the upper limit, and continues recording until the SD memory card will reach the capacity limit. If the SD memory card is not inserted when the internal memory reaches the upper limit, recording ends.

(Data can be output to the SD memory card by pressing the button after inserting the SD memory card.)

- *4 A mode to record the latest measurement value for the maximum capacity of the internal memory at all times. (When reaching the upper limit of the internal memory, data item will be discarded from the oldest.)
- *5 Output when the value exceeds the upper limit that has been set in threshold value setting mode, or falls short of the lower limit.
- *6 Except for Air Particle Sensor connection mode.
- *7 When using a third party SD card, it is recommended to use a reliable and durable industrial SD card (SD standard or SDHC standard (not compliant with SDXC standard), Class 4 or higher, flash memory type SLC or MLC type). You must confirm the operation of the SD card yourself.
- *8 Nickel metal hydride batteries or alkaline batteries can be used. Manganese batteries cannot be used.
- *9 The battery life varies according to measurement environment, sampling, measurement operation mode, battery's type and performance.
- *10 In case using Mounting Magnet ZN9-EM01-S (sold separately), install the product in a location where impact is not applied. Vibration resistance is 10 to 50 Hz, double amplitude 0.3 mm, acceleration 20 m/s², 50 min for each in X, Y and Z directions.
- *11 The attached connector is XW4B-02B1-H1.

7.1.3 ZN-THX11-S

Item	ZN-THX11-S	ZN-THX11-SA
Connectable sensor	Air Particle Sensor Head ZN-THS1□□-S	
Display	LCD 7-seg 5-digit 2-step display, auxiliary information indicator display	
Measurement cycle	10s,20s,30s,1min,2min,5min,10min,20min,30min,1h	
Processing mode	Instantaneous value, maximum value, minimum value, average value	
Measurement operation mode	Normal mode, sleep mode ^{*1}	
Recording mode	Continue ^{*2} , ring ^{*3}	
External output	Alarm output ^{*4} (Photocoupler output) Alarm hold is configurable.	
Memory capacity (internal)	Internal memory: Approx. 8,500 data items	
Storage device (external)	SD memory card (SDHC support, measured value saving/set value saving and reading), Recommended SD memory card: HMC-SD292 (2GB) / HMC-SD492 (4GB) (manufactured by OMRON) ^{*5}	
Power supply	DC input: 24 VDC±10%, AC adapter: 100 to 240 VAC/50 to 60 Hz, Battery: 2 AAA batteries ^{*6}	
Current consumption	70 mA max. (AC adapter used)	
Battery life ^{*7}	Approx. 1 year (2 AAA nickel metal hydride (Ni-MH) batteries, sleep mode, measurement interval of 10 minutes, and SD memory card not inserted)	
Operating temperature	Main unit: 0 to 60°C, AC adapter: 0 to 40°C	
Storage temperature	-15 to 60°C (no condensation or icing)	
Operating humidity	20 to 85%RH (no condensation)	
Storage humidity	20 to 85%RH (no condensation or icing)	
Insulation resistance	20 MΩ (500 VDC)	
Withstand voltage	1000 VAC, 50/60 Hz 1 min	
Vibration resistance	10 to 150 Hz, 0.35 mm double amplitude, acceleration: 50 m/s ² for each in X, Y and Z directions for 80 min ^{*8}	
Shock resistance	150 m/s ² in 6 directions (+/-X, +/-Y, and +/-Z directions), 3 times each ^{*8}	
Material	ABS	
Degree of protection	IP30	
Mounting method	Screw mounting, hook, floor installation	
Dimensions (WDH)	117.2×24.6×56.8 mm (excluding protruding part)	
Weight (packaged)	Approx. 500g	
Accessories 1	Instruction sheet, Startup guide, Alarm output connector ^{**9}	
Accessories 2	AC adapter	DC cable, Ferrite core

*1 Power saving mode. The display is always OFF in default setting (It turns ON with button operation).

*2 Automatically writes data into the SD memory card when the internal memory reaches the upper limit, and continues recording until the SD memory card will reach the capacity limit. If the SD memory card is not inserted when the internal memory reaches the upper limit, recording ends. (Data can be output to the SD memory card by pressing the button after inserting the SD memory card.)

*3 A mode to record the latest measurement value for the maximum capacity of the internal memory at all times. (When reaching the upper limit of the internal memory, data item will be discarded from the oldest.)

- *4 Output when the value exceeds the upper limit that has been set in threshold value setting mode, or falls short of the lower limit.
- *5 When using a third party SD card, it is recommended to use a reliable and durable industrial SD card (SD standard or SDHC standard (not compliant with SDXC standard), Class 4 or higher, flash memory type SLC or MLC type). You must confirm the operation of the SD card yourself.
- *6 Nickel metal hydride batteries or alkaline batteries can be used. Manganese batteries cannot be used.
- *7 The battery life varies according to measurement environment, sampling, measurement operation mode, battery's type and performance.
- *8 In case using Mounting Magnet ZN9-EM01-S (sold separately), install the product in a location where impact is not applied.
Vibration resistance is 10 to 50 Hz, double amplitude 0.3 mm, acceleration 20 m/s², 50 min for each in X, Y and Z directions.
- *9 The attached connector is XW4B-02B1-H1.

7.2 List of Displayed Errors

Display Upper/lower	Content	Action to be taken
DATA E1100	Failed to write measured data	Failed to write the recorded data to the SD memory card due to no free space or card being removed during writing. Insert the writable SD memory card. Hold the MODE key for 3 seconds or more to release the error display.
SEN E2000	Sensor error	The sensor Head is not connected. Connect the Sensor Head properly.
NO SD E3000	SD memory card not inserted	SD memory card is not inserted. Insert the writable SD memory card. Hold the MODE key for 3 seconds or more to release the error display.
BATLO E3001	Unable to access SD memory card	Unable to access to the SD memory card due to low battery voltage. Replace the battery or connect to the AC adapter. Hold the MODE key for 3 seconds or more to release the error display.
SDLCK E3002	SD memory card write prohibited	Writing to the SD memory card is prohibited. Insert the writable SD memory card. Hold the MODE key for 3 seconds or more to release the error display.
SD ER E3003	SD memory card recognition error	Failed to recognize the SD memory card. Insert an appropriate SD memory card. Hold the MODE key for 3 seconds or more to release the error display.
PDINT E4000	Air Particle Sensor (ZN-PD□□-S□) communication initialization error	Air Particle Sensor cannot be initialized. Connect with Air Particle Sensor properly. Hold the MODE key for 3 seconds or more to release the error display.
PD-S E4001	Air Particle Sensor (ZN-PD□□-S□) measurement acquisition error	Failed to obtain the measured value from the Air Particle Sensor. Connect with the Air Particle Sensor properly. Hold the MODE key for 3 seconds or more to release the error display.
RESTR E5000	Invalid setting file data	The setting data within the SD memory card is invalid due to invalid model type or setting value. Hold the MODE key for 3 seconds or more to release the error display.
BCKUP E5001	Failed to write the setting file	Failed to write to the SD memory card of the setting file due to no free space or writing prohibited. Insert a writable SD memory card. Hold the MODE key for 3 seconds or more to release the error display.
RESTR E5002	Failed to read the setting file	There is not setting file in the SD memory card. Insert the SD memory card in which the setting file has been written. Hold the MODE key for 3 seconds or more to release the error display.
HARD E****	Hardware error	There may be a hardware error. Please contact the distributor or OMRON representative office to inform the displayed error code.

7.3 List of Displayed Characters

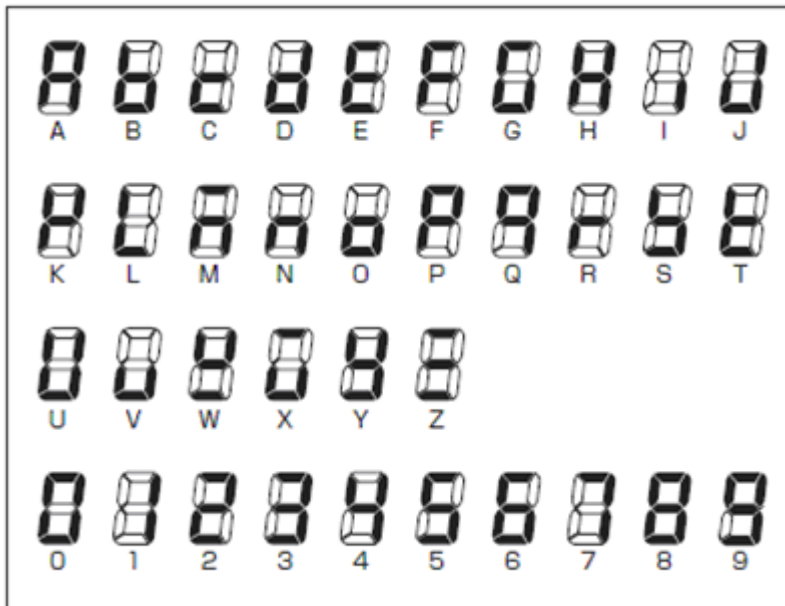

Major messages

Display	Character strings	Display	Character strings	Display	Character strings
<i>cYcLE</i>	CYCLE	<i>SDISP</i>	SDISP	<i>DP HI</i>	DP HI
<i>MEAS</i>	MEAS	<i>OFF</i>	OFF	<i>DP LO</i>	DP LO
<i>PD-S</i>	PD-S	<i>ON</i>	ON	<i>HOLD</i>	HOLD
<i>MODE</i>	MODE	<i>DISP</i>	DISP	<i>RESET</i>	RESET
<i>REC</i>	REC	<i>NORM</i>	NORM	<i>DONE</i>	DONE
<i>INIT</i>	INIT	<i>MAX</i>	MAX	<i>DATA</i>	DATA
<i>ETC</i>	ETC	<i>MIN</i>	MIN	<i>SEN</i>	SEN
<i>RESTR</i>	RESTR	<i>AVE</i>	AVE	<i>NO SD</i>	NO SD
<i>BCKUP</i>	BCKUP	<i>NET</i>	NET	<i>SDLCK</i>	SDLCK
<i>TIME</i>	TIME	<i>SLEEP</i>	SLEEP	<i>HARD</i>	HARD
<i>YEAR</i>	YEAR	<i>IP</i>	IP		
<i>MONTH</i>	MONTH	<i>SUB</i>	SUB		
<i>DAY</i>	DAY	<i>CONT</i>	CONT		
<i>CLOCK</i>	CLOCK	<i>RING</i>	RING		

7.4 Configuration of SD memory card Folder

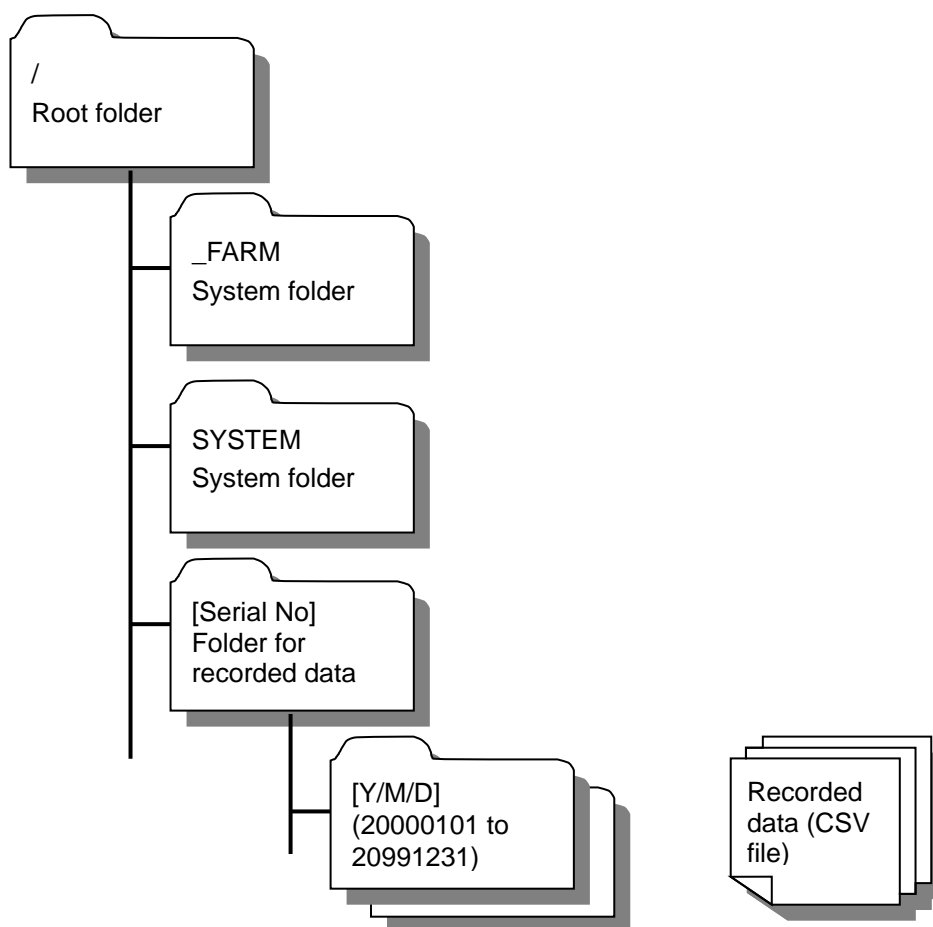

File/folder name	Content
_FARM	For system. Do not change the file name or internal file.
SYSTEM	For system. Do not change the file name or internal file.
“Serial No”	Folder to store recorded data. The serial number of the Differential Pressure Station, Thermo-Humidity Station or Air Thermo Logger is used for the folder name.
“Y/M/D”	Subfolder to store recorded data. Recorded date (YYYYMMDD) is used for the folder name. The recorded data file is CSV format. The file name is as follows. “Hour, minute, second + serial No” .CSV Example: 12345601.CSV Recorded data file written to the file at 12:24:56.

7.5 Calibration

Calibration is not required for the unit.

Perform calibration for the Differential Pressure Sensor Head (ZN-DPS1□□-S) and Air Thermo Sensor Head (ZN-THS1□□-S).

Read the Instruction Sheet of the Sensor Head.

Revision History

The specifications of this product you have just purchased are subject to changes in adding new functions or making improvements. This operation manual will be revised whenever such changes incur with the changes reflected on its contents. The revised manual contains the history of revision with the manual revision codes and the revision descriptions.

About the manual revision code

The manual revision code is affixed to the tail of the “Rev. No.” given in the lower right corner of the manual.

Rev.□

Revision code

History of Revision

Revision code	Date	Description of revision
01	July 2019	First edition
02	March 2023	Revisions for adding safety precautions regarding security.
03	July 2023	Correction of descriptions.

OMRON Corporation Industrial Automation Company

Kyoto, JAPAN

Contact : www.ia.omron.com

Regional Headquarters

OMRON EUROPE B.V.

Wegalaan 67-69, 2132 JD Hoofddorp
The Netherlands

Tel: (31) 2356-81-300 Fax: (31) 2356-81-388

OMRON ELECTRONICS LLC

2895 Greenspoint Parkway, Suite 200
Hoffman Estates, IL 60169 U.S.A.

Tel: (1) 847-843-7900 Fax: (1) 847-843-7787

OMRON ASIA PACIFIC PTE. LTD.

438B Alexandra Road, #08-01/02 Alexandra
Technopark, Singapore 119968

Tel: (65) 6835-3011 Fax: (65) 6835-2711

OMRON (CHINA) CO., LTD.

Room 2211, Bank of China Tower,
200 Yin Cheng Zhong Road,
PuDong New Area, Shanghai, 200120, China

Tel: (86) 21-5037-2222 Fax: (86) 21-5037-2200

Authorized Distributor:

©OMRON Corporation 2019-2023 All Rights Reserved.
In the interest of product improvement,
specifications are subject to change without notice.

Cat. No. Z409-E1-03

Printed in Japan
0723